







Assembly code	Assembly revision	Assembly image
ASM3069A/0.D04	Electrical system	
ASM3007A/0.D04	Door	
ASM1745A/0.D03	Cooking chamber	
ASM1771A/0.D04	External cover	

ASM3069A/0.D04 - Electrical system

FRONT

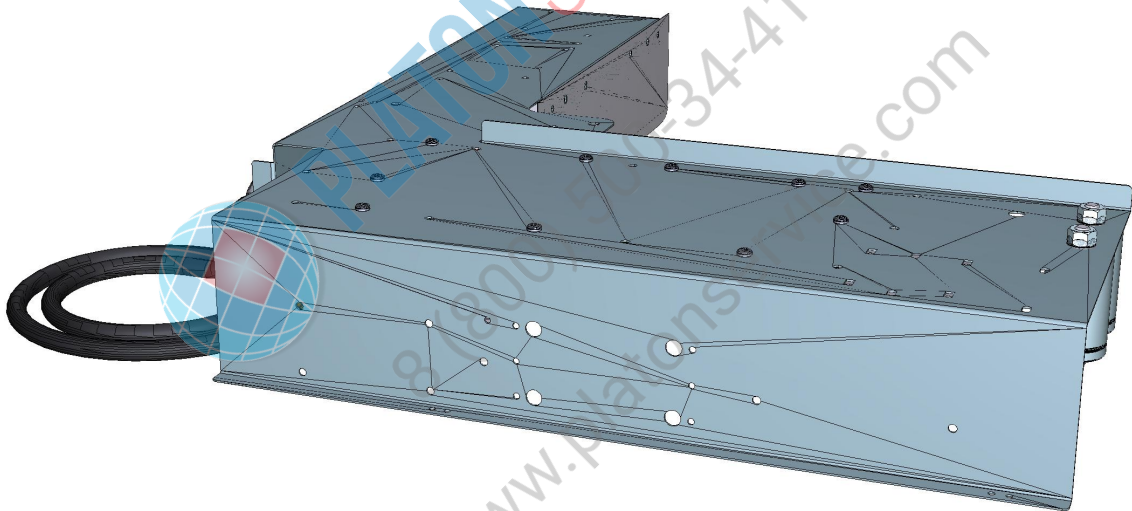



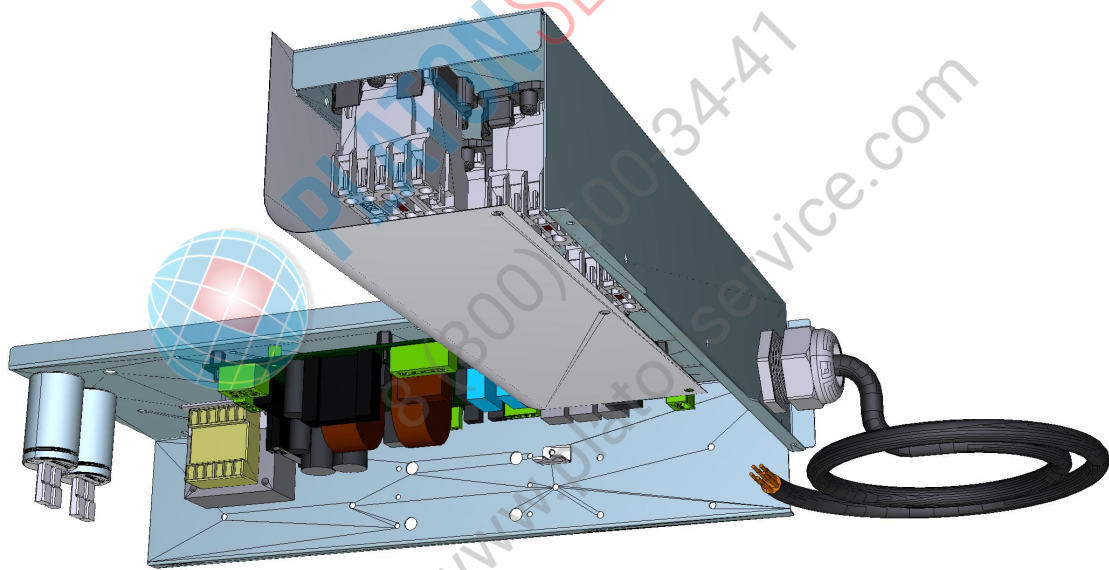

ASM3069A/0.D04 - Electrical system

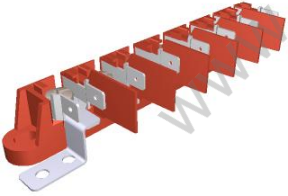
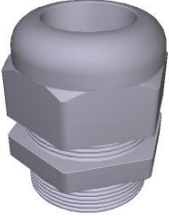
REAR

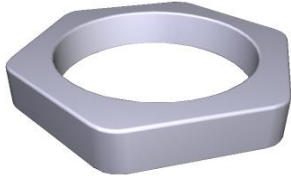

COMPONENT			SPARE PART																		
Code	Description	Image	Code	Description	Components list																
CN1003A	6,3 UF MOTOR CAPACITOR		KCN1003A	6,3 UF MOTOR CAPACITOR KIT	<table border="1"> <thead> <tr> <th>Code</th> <th>Description</th> <th>Qty</th> <th>UOM</th> </tr> </thead> <tbody> <tr> <td>CN1003A0</td> <td>6,3 UF MOTOR CAPACITOR</td> <td>1</td> <td>PZ</td> </tr> <tr> <td>VI1931A0</td> <td>M8 NUT+INDENTE D WASHER D=8 X COND.</td> <td>1</td> <td>PZ</td> </tr> <tr> <td>VI1932A0</td> <td>M8 NUT+INDENTE D WASHER D=8 X COND.</td> <td>1</td> <td>PZ</td> </tr> </tbody> </table>	Code	Description	Qty	UOM	CN1003A0	6,3 UF MOTOR CAPACITOR	1	PZ	VI1931A0	M8 NUT+INDENTE D WASHER D=8 X COND.	1	PZ	VI1932A0	M8 NUT+INDENTE D WASHER D=8 X COND.	1	PZ
Code	Description	Qty	UOM																		
CN1003A0	6,3 UF MOTOR CAPACITOR	1	PZ																		
VI1931A0	M8 NUT+INDENTE D WASHER D=8 X COND.	1	PZ																		
VI1932A0	M8 NUT+INDENTE D WASHER D=8 X COND.	1	PZ																		
VE1115A	20 A 230V 4 POLES MINICONTACTOR		KVE1115A	20A 230V 4 POLES MINICONTACTOR KI	<table border="1"> <thead> <tr> <th>Code</th> <th>Description</th> <th>Qty</th> <th>UOM</th> </tr> </thead> <tbody> <tr> <td>VE1115A0</td> <td>20 A 230V 4 POLES MINICONTACTOR</td> <td>1</td> <td>PZ</td> </tr> <tr> <td>VM1075A1</td> <td>PLASTIC CLIP TO FIX CONTACTORS</td> <td>4</td> <td>PZ</td> </tr> </tbody> </table>	Code	Description	Qty	UOM	VE1115A0	20 A 230V 4 POLES MINICONTACTOR	1	PZ	VM1075A1	PLASTIC CLIP TO FIX CONTACTORS	4	PZ				
Code	Description	Qty	UOM																		
VE1115A0	20 A 230V 4 POLES MINICONTACTOR	1	PZ																		
VM1075A1	PLASTIC CLIP TO FIX CONTACTORS	4	PZ																		
VM1056A	SMALL CONTACTOR BRACKET VE1115A		VM1056A0	SMALL CONTACTOR BRACKET VE1115A																	
MR1004A	41A 450V 7 POLES TERMINAL		KMR1004A	7FTW 1+2+3/4+5+6 TERMINAL BLOCK KIT	<table border="1"> <thead> <tr> <th>Code</th> <th>Description</th> <th>Qty</th> <th>UOM</th> </tr> </thead> <tbody> <tr> <td>MR1004A1</td> <td>41A 450V 7 POLES TERMINAL</td> <td>1</td> <td>PZ</td> </tr> </tbody> </table>	Code	Description	Qty	UOM	MR1004A1	41A 450V 7 POLES TERMINAL	1	PZ								
Code	Description	Qty	UOM																		
MR1004A1	41A 450V 7 POLES TERMINAL	1	PZ																		
VE1645A	PG 29 STRAIN RELIEF																				

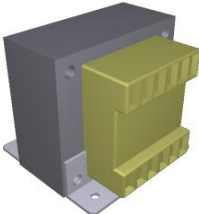
COMPONENT			SPARE PART																						
Code	Description	Image	Code	Description	Components list																				
VE1644A	PG 29 STRAIN RELIEF NUT		VE1644A0	PG 29 STRAIN RELIEF NUT																					
0H7374A	CORE PROBE CABLE PLATE		0H7374A0	CORE PROBE CABLE PLATE																					
CE1355A	CABLE 5 X 2,5 MMQ H07RNF L = 1,5 MT		KCE1355A	CONNECTOR KIT	<table border="1"> <thead> <tr> <th>Code</th> <th>Description</th> <th>Qty</th> <th>UOM</th> </tr> </thead> <tbody> <tr> <td>CE1355A1</td> <td>CABLE 5 X 2,5 MMQ H07RNF L = 1,5 MT</td> <td>1</td> <td>PZ</td> </tr> </tbody> </table>	Code	Description	Qty	UOM	CE1355A1	CABLE 5 X 2,5 MMQ H07RNF L = 1,5 MT	1	PZ												
Code	Description	Qty	UOM																						
CE1355A1	CABLE 5 X 2,5 MMQ H07RNF L = 1,5 MT	1	PZ																						
PE2037A	MIND.MAPS ONE POWER CARD		KPE2037A	MIND.MAPS ONE POWER BOARD KIT	<table border="1"> <thead> <tr> <th>Code</th> <th>Description</th> <th>Qty</th> <th>UOM</th> </tr> </thead> <tbody> <tr> <td>PE2037A0</td> <td>MIND.MAPS ONE POWER CARD</td> <td>1</td> <td>PZ</td> </tr> <tr> <td>VI1850A0</td> <td>M4X6 NICKEL PLATED FIXING SCRE</td> <td>9</td> <td>PZ</td> </tr> <tr> <td>VM1745A0</td> <td>CARD SUPPORT</td> <td>9</td> <td>PZ</td> </tr> <tr> <td>VM2147A0</td> <td>ESD SPONGE PINK SMOOTH 410X343X15 M</td> <td>1</td> <td>PZ</td> </tr> </tbody> </table>	Code	Description	Qty	UOM	PE2037A0	MIND.MAPS ONE POWER CARD	1	PZ	VI1850A0	M4X6 NICKEL PLATED FIXING SCRE	9	PZ	VM1745A0	CARD SUPPORT	9	PZ	VM2147A0	ESD SPONGE PINK SMOOTH 410X343X15 M	1	PZ
Code	Description	Qty	UOM																						
PE2037A0	MIND.MAPS ONE POWER CARD	1	PZ																						
VI1850A0	M4X6 NICKEL PLATED FIXING SCRE	9	PZ																						
VM1745A0	CARD SUPPORT	9	PZ																						
VM2147A0	ESD SPONGE PINK SMOOTH 410X343X15 M	1	PZ																						
VE1639A	TRANSFORMER 230-12VAC 60VA		KVE1639A	230-12VAC 60VA TRANSFORMER KIT	<table border="1"> <thead> <tr> <th>Code</th> <th>Description</th> <th>Qty</th> <th>UOM</th> </tr> </thead> <tbody> <tr> <td>VE1639A0</td> <td>TRANSFORME R 230-12VAC 60VA</td> <td>1</td> <td>PZ</td> </tr> <tr> <td>VI1950A0</td> <td>ST. STEEL 4,2X13 TCB SELF-DRILLIN G SCREW</td> <td>4</td> <td>PZ</td> </tr> <tr> <td>VM2147A0</td> <td>ESD SPONGE PINK SMOOTH 410X343X15 M</td> <td>1</td> <td>PZ</td> </tr> </tbody> </table>	Code	Description	Qty	UOM	VE1639A0	TRANSFORME R 230-12VAC 60VA	1	PZ	VI1950A0	ST. STEEL 4,2X13 TCB SELF-DRILLIN G SCREW	4	PZ	VM2147A0	ESD SPONGE PINK SMOOTH 410X343X15 M	1	PZ				
Code	Description	Qty	UOM																						
VE1639A0	TRANSFORME R 230-12VAC 60VA	1	PZ																						
VI1950A0	ST. STEEL 4,2X13 TCB SELF-DRILLIN G SCREW	4	PZ																						
VM2147A0	ESD SPONGE PINK SMOOTH 410X343X15 M	1	PZ																						

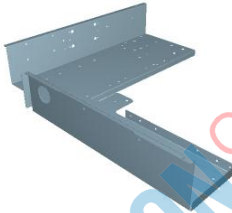

COMPONENT			SPARE PART		
Code	Description	Image	Code	Description	Components list
VM2387A	XEVC MM CONTACTORS PROTECTION		VM2387A0	XEVC MM CONTACTORS PROTECTION	
0H7371A	XEBC MM COMPONENTS HOLDING PLATE		0H7371A0	XEBC MM COMPONENTS HOLDING PLATE	



PLATON SERVICE  
8 (800) 500-34-47  
www.platonservice.com

ASM3007A/0.D04 - Door

FRONT

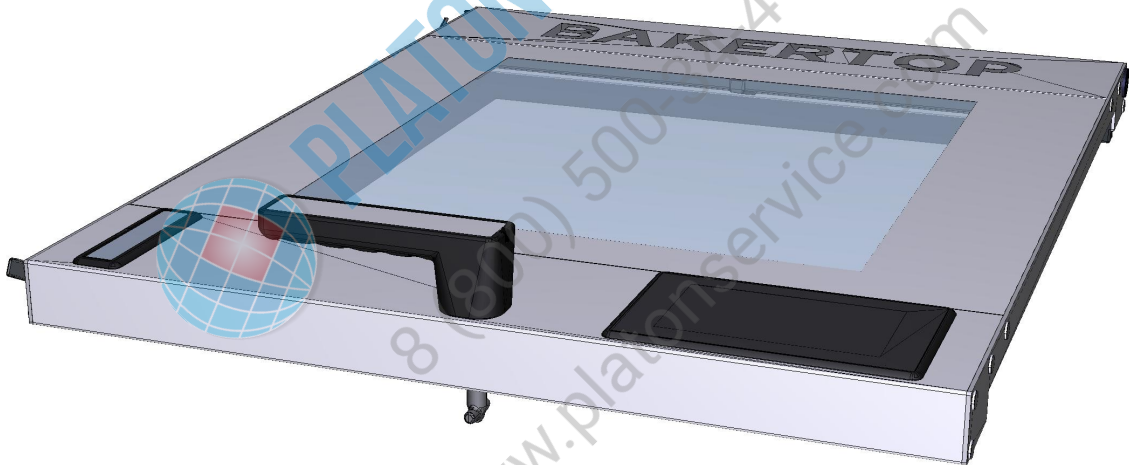

ASM3007A/0.D04 - Door

REAR

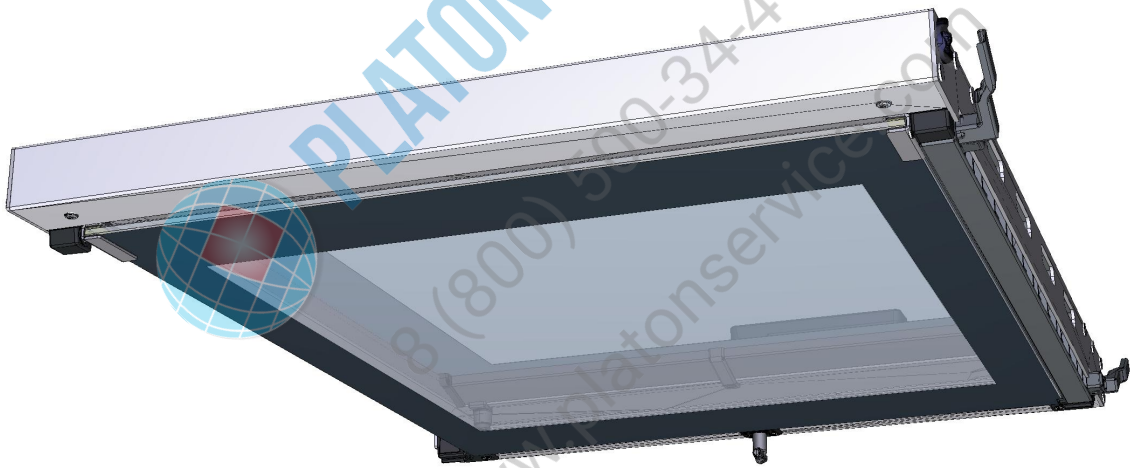



COMPONENT			SPARE PART																																																																		
Code	Description	Image	Code	Description	Components list																																																																
MG1083A	MIND.MAPS DOOR COMPLETE HANDLE		KMG1083A	MIND.MAPS SERIES HANDLE KIT	<table border="1"> <thead> <tr> <th>Code</th> <th>Description</th> <th>Qty</th> <th>UOM</th> </tr> </thead> <tbody> <tr> <td>0H7321A0</td> <td>MM STAINLESS STEEL HANDLE COVE</td> <td>1</td> <td>PZ</td> </tr> <tr> <td>RC1200A0</td> <td>ED=4 WIRE D.=0.5 COMPRESSIO N SPRING</td> <td>4</td> <td>PZ</td> </tr> <tr> <td>VI0239A1</td> <td>SELF-TAPPIN G SCREW 4.2X25 TCB+ INOX</td> <td>4</td> <td>PZ</td> </tr> <tr> <td>VI1220A1</td> <td>4,2X12 TCB SELF-TAPPIN G SCREW</td> <td>2</td> <td>PZ</td> </tr> <tr> <td>VM1182B0</td> <td>E. S. CT BT HANDLE JUNCTION + PIN GUIDE</td> <td>1</td> <td>PZ</td> </tr> <tr> <td>VM1182B1</td> <td>E. S. CT BT HANDLE JUNCTION + PIN GUIDE</td> <td>1</td> <td>PZ</td> </tr> <tr> <td>VM1183A1</td> <td>CHEFTOP/BAK ERTOP HANDLE PIN</td> <td>1</td> <td>PZ</td> </tr> <tr> <td>VM1183B0</td> <td>CHEFTOP/BAK ERTOP HANDLE PIN</td> <td>1</td> <td>PZ</td> </tr> <tr> <td>VM1490A0</td> <td>CHEFTOP/BAK ERTOP HANDLE SCREWS COVER</td> <td>2</td> <td>PZ</td> </tr> <tr> <td>VM1695A0</td> <td>HANDLE POSITION PIN</td> <td>4</td> <td>PZ</td> </tr> <tr> <td>VM2245A0</td> <td>HANDLE SHAFT WITH LATCH</td> <td>1</td> <td>PZ</td> </tr> <tr> <td>VM2247A0</td> <td>HANDLE SHAFT COVER VM2245-2246</td> <td>1</td> <td>PZ</td> </tr> <tr> <td>VM2248A0</td> <td>CLOSING HANDLE KEY WITH LATCH</td> <td>1</td> <td>PZ</td> </tr> <tr> <td>VM2248B0</td> <td>CLOSING HANDLE KEY WITH LATCH</td> <td>1</td> <td>PZ</td> </tr> <tr> <td>VM2295A0</td> <td>STYLUS PEN FOR MM</td> <td>1</td> <td>PZ</td> </tr> </tbody> </table>	Code	Description	Qty	UOM	0H7321A0	MM STAINLESS STEEL HANDLE COVE	1	PZ	RC1200A0	ED=4 WIRE D.=0.5 COMPRESSIO N SPRING	4	PZ	VI0239A1	SELF-TAPPIN G SCREW 4.2X25 TCB+ INOX	4	PZ	VI1220A1	4,2X12 TCB SELF-TAPPIN G SCREW	2	PZ	VM1182B0	E. S. CT BT HANDLE JUNCTION + PIN GUIDE	1	PZ	VM1182B1	E. S. CT BT HANDLE JUNCTION + PIN GUIDE	1	PZ	VM1183A1	CHEFTOP/BAK ERTOP HANDLE PIN	1	PZ	VM1183B0	CHEFTOP/BAK ERTOP HANDLE PIN	1	PZ	VM1490A0	CHEFTOP/BAK ERTOP HANDLE SCREWS COVER	2	PZ	VM1695A0	HANDLE POSITION PIN	4	PZ	VM2245A0	HANDLE SHAFT WITH LATCH	1	PZ	VM2247A0	HANDLE SHAFT COVER VM2245-2246	1	PZ	VM2248A0	CLOSING HANDLE KEY WITH LATCH	1	PZ	VM2248B0	CLOSING HANDLE KEY WITH LATCH	1	PZ	VM2295A0	STYLUS PEN FOR MM	1	PZ
Code	Description	Qty	UOM																																																																		
0H7321A0	MM STAINLESS STEEL HANDLE COVE	1	PZ																																																																		
RC1200A0	ED=4 WIRE D.=0.5 COMPRESSIO N SPRING	4	PZ																																																																		
VI0239A1	SELF-TAPPIN G SCREW 4.2X25 TCB+ INOX	4	PZ																																																																		
VI1220A1	4,2X12 TCB SELF-TAPPIN G SCREW	2	PZ																																																																		
VM1182B0	E. S. CT BT HANDLE JUNCTION + PIN GUIDE	1	PZ																																																																		
VM1182B1	E. S. CT BT HANDLE JUNCTION + PIN GUIDE	1	PZ																																																																		
VM1183A1	CHEFTOP/BAK ERTOP HANDLE PIN	1	PZ																																																																		
VM1183B0	CHEFTOP/BAK ERTOP HANDLE PIN	1	PZ																																																																		
VM1490A0	CHEFTOP/BAK ERTOP HANDLE SCREWS COVER	2	PZ																																																																		
VM1695A0	HANDLE POSITION PIN	4	PZ																																																																		
VM2245A0	HANDLE SHAFT WITH LATCH	1	PZ																																																																		
VM2247A0	HANDLE SHAFT COVER VM2245-2246	1	PZ																																																																		
VM2248A0	CLOSING HANDLE KEY WITH LATCH	1	PZ																																																																		
VM2248B0	CLOSING HANDLE KEY WITH LATCH	1	PZ																																																																		
VM2295A0	STYLUS PEN FOR MM	1	PZ																																																																		



COMPONENT			SPARE PART																																																			
Code	Description	Image	Code	Description	Components list																																																	
VM2274A	GROOVED BUSHING		KVM2274A	GROOVED PIN BUSHING KIT	<table border="1"> <thead> <tr> <th>Code</th> <th>Description</th> <th>Qty</th> <th>UOM</th> </tr> </thead> <tbody> <tr> <td>VM2274A0</td> <td>GROOVED BUSHING</td> <td>1</td> <td>PZ</td> </tr> </tbody> </table>	Code	Description	Qty	UOM	VM2274A0	GROOVED BUSHING	1	PZ																																									
			Code	Description	Qty	UOM																																																
VM2274A0	GROOVED BUSHING	1	PZ																																																			
K0B1126AR	BAKERTOP MM RIGHT DOOR LOWER BEAM KIT	<table border="1"> <thead> <tr> <th>Code</th> <th>Description</th> <th>Qty</th> <th>UOM</th> </tr> </thead> <tbody> <tr> <td>OB1126A0</td> <td>DOOR LOWER FRAME SHAPE 860 MM</td> <td>1</td> <td>PZ</td> </tr> <tr> <td>RC1200A0</td> <td>ED=4 WIRE D.=0.5 COMPRESSIO N SPRING</td> <td>2</td> <td>PZ</td> </tr> <tr> <td>VI1220A1</td> <td>4,2X12 TCB SELF-TAPPIN G SCREW</td> <td>1</td> <td>PZ</td> </tr> <tr> <td>VI1996A0</td> <td>M5X35 SCREW</td> <td>7</td> <td>PZ</td> </tr> <tr> <td>VM1794A0</td> <td>250X4.8 PA66 BLACK CLAMP</td> <td>2</td> <td>PZ</td> </tr> <tr> <td>VM2103A0</td> <td>CLAMP LOCK</td> <td>2</td> <td>PZ</td> </tr> <tr> <td>VM2259A1</td> <td>6 SERIES DOOR LOWER LEFT CAP</td> <td>1</td> <td>PZ</td> </tr> <tr> <td>VM2261A1</td> <td>6 SERIES DOOR LOWER RIGHT CAP</td> <td>1</td> <td>PZ</td> </tr> <tr> <td>VM2267A0</td> <td>INTERNAL GLASS LOCKING SYSTEM SLIDER</td> <td>1</td> <td>PZ</td> </tr> <tr> <td>VM2269A0</td> <td>INTERNAL GLASS LOCKING SYSTEM CAP</td> <td>1</td> <td>PZ</td> </tr> <tr> <td>VM2274A0</td> <td>GROOVED BUSHING</td> <td>1</td> <td>PZ</td> </tr> <tr> <td>VM2305A0</td> <td>6 SERIES DOOR CAP FIXING PAWL</td> <td>7</td> <td>PZ</td> </tr> </tbody> </table>	Code	Description	Qty	UOM	OB1126A0	DOOR LOWER FRAME SHAPE 860 MM	1	PZ	RC1200A0	ED=4 WIRE D.=0.5 COMPRESSIO N SPRING	2	PZ	VI1220A1	4,2X12 TCB SELF-TAPPIN G SCREW	1	PZ	VI1996A0	M5X35 SCREW	7	PZ	VM1794A0	250X4.8 PA66 BLACK CLAMP	2	PZ	VM2103A0	CLAMP LOCK	2	PZ	VM2259A1	6 SERIES DOOR LOWER LEFT CAP	1	PZ	VM2261A1	6 SERIES DOOR LOWER RIGHT CAP	1	PZ	VM2267A0	INTERNAL GLASS LOCKING SYSTEM SLIDER	1	PZ	VM2269A0	INTERNAL GLASS LOCKING SYSTEM CAP	1	PZ	VM2274A0	GROOVED BUSHING	1	PZ	VM2305A0	6 SERIES DOOR CAP FIXING PAWL	7	PZ
Code	Description	Qty	UOM																																																			
OB1126A0	DOOR LOWER FRAME SHAPE 860 MM	1	PZ																																																			
RC1200A0	ED=4 WIRE D.=0.5 COMPRESSIO N SPRING	2	PZ																																																			
VI1220A1	4,2X12 TCB SELF-TAPPIN G SCREW	1	PZ																																																			
VI1996A0	M5X35 SCREW	7	PZ																																																			
VM1794A0	250X4.8 PA66 BLACK CLAMP	2	PZ																																																			
VM2103A0	CLAMP LOCK	2	PZ																																																			
VM2259A1	6 SERIES DOOR LOWER LEFT CAP	1	PZ																																																			
VM2261A1	6 SERIES DOOR LOWER RIGHT CAP	1	PZ																																																			
VM2267A0	INTERNAL GLASS LOCKING SYSTEM SLIDER	1	PZ																																																			
VM2269A0	INTERNAL GLASS LOCKING SYSTEM CAP	1	PZ																																																			
VM2274A0	GROOVED BUSHING	1	PZ																																																			
VM2305A0	6 SERIES DOOR CAP FIXING PAWL	7	PZ																																																			
K0B1126AL	BAKERTOP MM LEFT DOOR LOWER BEAM KIT	<table border="1"> <thead> <tr> <th>Code</th> <th>Description</th> <th>Qty</th> <th>UOM</th> </tr> </thead> <tbody> <tr> <td>OB1126A0</td> <td>DOOR LOWER FRAME SHAPE 860 MM</td> <td>1</td> <td>PZ</td> </tr> <tr> <td>RC1200A0</td> <td>ED=4 WIRE D.=0.5 COMPRESSIO N SPRING</td> <td>2</td> <td>PZ</td> </tr> <tr> <td>VI1220A1</td> <td>4,2X12 TCB SELF-TAPPIN G SCREW</td> <td>1</td> <td>PZ</td> </tr> <tr> <td>VI1996A0</td> <td>M5X35 SCREW</td> <td>7</td> <td>PZ</td> </tr> <tr> <td>VM1794A0</td> <td>250X4.8 PA66 BLACK CLAMP</td> <td>2</td> <td>PZ</td> </tr> <tr> <td>VM2103A0</td> <td>CLAMP LOCK</td> <td>2</td> <td>PZ</td> </tr> </tbody> </table>	Code	Description	Qty	UOM	OB1126A0	DOOR LOWER FRAME SHAPE 860 MM	1	PZ	RC1200A0	ED=4 WIRE D.=0.5 COMPRESSIO N SPRING	2	PZ	VI1220A1	4,2X12 TCB SELF-TAPPIN G SCREW	1	PZ	VI1996A0	M5X35 SCREW	7	PZ	VM1794A0	250X4.8 PA66 BLACK CLAMP	2	PZ	VM2103A0	CLAMP LOCK	2	PZ																								
Code	Description	Qty	UOM																																																			
OB1126A0	DOOR LOWER FRAME SHAPE 860 MM	1	PZ																																																			
RC1200A0	ED=4 WIRE D.=0.5 COMPRESSIO N SPRING	2	PZ																																																			
VI1220A1	4,2X12 TCB SELF-TAPPIN G SCREW	1	PZ																																																			
VI1996A0	M5X35 SCREW	7	PZ																																																			
VM1794A0	250X4.8 PA66 BLACK CLAMP	2	PZ																																																			
VM2103A0	CLAMP LOCK	2	PZ																																																			



COMPONENT			SPARE PART																																																						
Code	Description	Image	Code	Description	Components list																																																				
VM2274A	GROOVED BUSHING		K0B1126AL	BAKERTOP MM LEFT DOOR LOWER BEAM KIT	<table border="1"> <thead> <tr> <th>Code</th> <th>Description</th> <th>Qty</th> <th>UOM</th> </tr> </thead> <tbody> <tr> <td>VM2267A0</td> <td>INTERNAL GLASS LOCKING SYSTEM SLIDER</td> <td>1</td> <td>PZ</td> </tr> <tr> <td>VM2269A0</td> <td>INTERNAL GLASS LOCKING SYSTEM CAP</td> <td>1</td> <td>PZ</td> </tr> <tr> <td>VM2274A0</td> <td>GROOVED BUSHING</td> <td>1</td> <td>PZ</td> </tr> <tr> <td>VM2305A0</td> <td>6 SERIES DOOR CAP FIXING PAWL</td> <td>7</td> <td>PZ</td> </tr> <tr> <td>VM2384A0</td> <td>LEFT MM DOOR LOWER RIGHT CAP</td> <td>1</td> <td>PZ</td> </tr> <tr> <td>VM2386A1</td> <td>LEFT MM DOOR LOWER LEFT CAP</td> <td>1</td> <td>PZ</td> </tr> </tbody> </table>	Code	Description	Qty	UOM	VM2267A0	INTERNAL GLASS LOCKING SYSTEM SLIDER	1	PZ	VM2269A0	INTERNAL GLASS LOCKING SYSTEM CAP	1	PZ	VM2274A0	GROOVED BUSHING	1	PZ	VM2305A0	6 SERIES DOOR CAP FIXING PAWL	7	PZ	VM2384A0	LEFT MM DOOR LOWER RIGHT CAP	1	PZ	VM2386A1	LEFT MM DOOR LOWER LEFT CAP	1	PZ																								
Code	Description	Qty	UOM																																																						
VM2267A0	INTERNAL GLASS LOCKING SYSTEM SLIDER	1	PZ																																																						
VM2269A0	INTERNAL GLASS LOCKING SYSTEM CAP	1	PZ																																																						
VM2274A0	GROOVED BUSHING	1	PZ																																																						
VM2305A0	6 SERIES DOOR CAP FIXING PAWL	7	PZ																																																						
VM2384A0	LEFT MM DOOR LOWER RIGHT CAP	1	PZ																																																						
VM2386A1	LEFT MM DOOR LOWER LEFT CAP	1	PZ																																																						
			K0B1122AR	CHEFTOP MM RIGHT DOOR LOWER BEAM KIT	<table border="1"> <thead> <tr> <th>Code</th> <th>Description</th> <th>Qty</th> <th>UOM</th> </tr> </thead> <tbody> <tr> <td>0B1122A0</td> <td>6 SERIES DOOR LOWER FRAME SHAPE</td> <td>1</td> <td>PZ</td> </tr> <tr> <td>RC1200A0</td> <td>ED=4 WIRE D.=0.5 COMPRESSION N SPRING</td> <td>2</td> <td>PZ</td> </tr> <tr> <td>V11220A1</td> <td>4,2X12 TCB SELF-TAPPIN G SCREW</td> <td>1</td> <td>PZ</td> </tr> <tr> <td>V11996A0</td> <td>M5X35 SCREW</td> <td>7</td> <td>PZ</td> </tr> <tr> <td>VM1794A0</td> <td>250X4.8 PA66 BLACK CLAMP</td> <td>2</td> <td>PZ</td> </tr> <tr> <td>VM2103A0</td> <td>CLAMP LOCK</td> <td>2</td> <td>PZ</td> </tr> <tr> <td>VM2259A1</td> <td>6 SERIES DOOR LOWER LEFT CAP</td> <td>1</td> <td>PZ</td> </tr> <tr> <td>VM2261A1</td> <td>6 SERIES DOOR LOWER RIGHT CAP</td> <td>1</td> <td>PZ</td> </tr> <tr> <td>VM2267A0</td> <td>INTERNAL GLASS LOCKING SYSTEM SLIDER</td> <td>1</td> <td>PZ</td> </tr> <tr> <td>VM2269A0</td> <td>INTERNAL GLASS LOCKING SYSTEM CAP</td> <td>1</td> <td>PZ</td> </tr> <tr> <td>VM2274A0</td> <td>GROOVED BUSHING</td> <td>1</td> <td>PZ</td> </tr> <tr> <td>VM2305A0</td> <td>6 SERIES DOOR CAP FIXING PAWL</td> <td>7</td> <td>PZ</td> </tr> </tbody> </table>	Code	Description	Qty	UOM	0B1122A0	6 SERIES DOOR LOWER FRAME SHAPE	1	PZ	RC1200A0	ED=4 WIRE D.=0.5 COMPRESSION N SPRING	2	PZ	V11220A1	4,2X12 TCB SELF-TAPPIN G SCREW	1	PZ	V11996A0	M5X35 SCREW	7	PZ	VM1794A0	250X4.8 PA66 BLACK CLAMP	2	PZ	VM2103A0	CLAMP LOCK	2	PZ	VM2259A1	6 SERIES DOOR LOWER LEFT CAP	1	PZ	VM2261A1	6 SERIES DOOR LOWER RIGHT CAP	1	PZ	VM2267A0	INTERNAL GLASS LOCKING SYSTEM SLIDER	1	PZ	VM2269A0	INTERNAL GLASS LOCKING SYSTEM CAP	1	PZ	VM2274A0	GROOVED BUSHING	1	PZ	VM2305A0	6 SERIES DOOR CAP FIXING PAWL	7	PZ
Code	Description	Qty	UOM																																																						
0B1122A0	6 SERIES DOOR LOWER FRAME SHAPE	1	PZ																																																						
RC1200A0	ED=4 WIRE D.=0.5 COMPRESSION N SPRING	2	PZ																																																						
V11220A1	4,2X12 TCB SELF-TAPPIN G SCREW	1	PZ																																																						
V11996A0	M5X35 SCREW	7	PZ																																																						
VM1794A0	250X4.8 PA66 BLACK CLAMP	2	PZ																																																						
VM2103A0	CLAMP LOCK	2	PZ																																																						
VM2259A1	6 SERIES DOOR LOWER LEFT CAP	1	PZ																																																						
VM2261A1	6 SERIES DOOR LOWER RIGHT CAP	1	PZ																																																						
VM2267A0	INTERNAL GLASS LOCKING SYSTEM SLIDER	1	PZ																																																						
VM2269A0	INTERNAL GLASS LOCKING SYSTEM CAP	1	PZ																																																						
VM2274A0	GROOVED BUSHING	1	PZ																																																						
VM2305A0	6 SERIES DOOR CAP FIXING PAWL	7	PZ																																																						

COMPONENT			SPARE PART																																																						
Code	Description	Image	Code	Description	Components list																																																				
VM2274A	GROOVED BUSHING		K0B1122AL	CHEFTOP MM LEFT DOOR LOWER BEAM KIT	<table border="1"> <thead> <tr> <th>Code</th> <th>Description</th> <th>Qty</th> <th>UOM</th> </tr> </thead> <tbody> <tr> <td>0B1122A0</td> <td>6 SERIES DOOR LOWER FRAME SHAPE</td> <td>1</td> <td>PZ</td> </tr> <tr> <td>RC1200A0</td> <td>ED=4 WIRE D.=0.5 COMPRESSIO N SPRING</td> <td>2</td> <td>PZ</td> </tr> <tr> <td>V11220A1</td> <td>4,2X12 TCB SELF-TAPPIN G SCREW</td> <td>1</td> <td>PZ</td> </tr> <tr> <td>V11996A0</td> <td>M5X35 SCREW</td> <td>7</td> <td>PZ</td> </tr> <tr> <td>VM1794A0</td> <td>250X4.8 PA66 BLACK CLAMP</td> <td>2</td> <td>PZ</td> </tr> <tr> <td>VM2103A0</td> <td>CLAMP LOCK</td> <td>2</td> <td>PZ</td> </tr> <tr> <td>VM2267A0</td> <td>INTERNAL GLASS LOCKING SYSTEM SLIDER</td> <td>1</td> <td>PZ</td> </tr> <tr> <td>VM2269A0</td> <td>INTERNAL GLASS LOCKING SYSTEM CAP</td> <td>1</td> <td>PZ</td> </tr> <tr> <td>VM2274A0</td> <td>GROOVED BUSHING</td> <td>1</td> <td>PZ</td> </tr> <tr> <td>VM2305A0</td> <td>6 SERIES DOOR CAP FIXING PAWL</td> <td>7</td> <td>PZ</td> </tr> <tr> <td>VM2384A0</td> <td>LEFT MM DOOR LOWER RIGHT CAP</td> <td>1</td> <td>PZ</td> </tr> <tr> <td>VM2386A1</td> <td>LEFT MM DOOR LOWER LEFT CAP</td> <td>1</td> <td>PZ</td> </tr> </tbody> </table>	Code	Description	Qty	UOM	0B1122A0	6 SERIES DOOR LOWER FRAME SHAPE	1	PZ	RC1200A0	ED=4 WIRE D.=0.5 COMPRESSIO N SPRING	2	PZ	V11220A1	4,2X12 TCB SELF-TAPPIN G SCREW	1	PZ	V11996A0	M5X35 SCREW	7	PZ	VM1794A0	250X4.8 PA66 BLACK CLAMP	2	PZ	VM2103A0	CLAMP LOCK	2	PZ	VM2267A0	INTERNAL GLASS LOCKING SYSTEM SLIDER	1	PZ	VM2269A0	INTERNAL GLASS LOCKING SYSTEM CAP	1	PZ	VM2274A0	GROOVED BUSHING	1	PZ	VM2305A0	6 SERIES DOOR CAP FIXING PAWL	7	PZ	VM2384A0	LEFT MM DOOR LOWER RIGHT CAP	1	PZ	VM2386A1	LEFT MM DOOR LOWER LEFT CAP	1	PZ
Code	Description	Qty	UOM																																																						
0B1122A0	6 SERIES DOOR LOWER FRAME SHAPE	1	PZ																																																						
RC1200A0	ED=4 WIRE D.=0.5 COMPRESSIO N SPRING	2	PZ																																																						
V11220A1	4,2X12 TCB SELF-TAPPIN G SCREW	1	PZ																																																						
V11996A0	M5X35 SCREW	7	PZ																																																						
VM1794A0	250X4.8 PA66 BLACK CLAMP	2	PZ																																																						
VM2103A0	CLAMP LOCK	2	PZ																																																						
VM2267A0	INTERNAL GLASS LOCKING SYSTEM SLIDER	1	PZ																																																						
VM2269A0	INTERNAL GLASS LOCKING SYSTEM CAP	1	PZ																																																						
VM2274A0	GROOVED BUSHING	1	PZ																																																						
VM2305A0	6 SERIES DOOR CAP FIXING PAWL	7	PZ																																																						
VM2384A0	LEFT MM DOOR LOWER RIGHT CAP	1	PZ																																																						
VM2386A1	LEFT MM DOOR LOWER LEFT CAP	1	PZ																																																						
VM2305A	6 SERIES DOOR CAP FIXING PAWL		KVM2305A	MM FIXING DOOR THUB SCREWS 10 PCS KIT	<table border="1"> <thead> <tr> <th>Code</th> <th>Description</th> <th>Qty</th> <th>UOM</th> </tr> </thead> <tbody> <tr> <td>VM2305A0</td> <td>6 SERIES DOOR CAP FIXING PAWL</td> <td>10</td> <td>PZ</td> </tr> </tbody> </table>	Code	Description	Qty	UOM	VM2305A0	6 SERIES DOOR CAP FIXING PAWL	10	PZ																																												
Code	Description	Qty	UOM																																																						
VM2305A0	6 SERIES DOOR CAP FIXING PAWL	10	PZ																																																						
V11996A	M5X35 SCREW		V11996A0	M5X35 SCREW																																																					

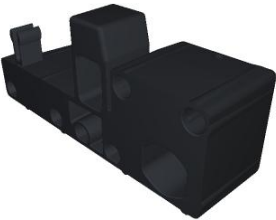

COMPONENT			SPARE PART																																																			
Code	Description	Image	Code	Description	Components list																																																	
VM2259A	6 SERIES DOOR LOWER LEFT CAP		KVM2259A	MIND MAPS DOOR LEFT LOWER CAP KI	<table border="1"> <thead> <tr> <th>Code</th> <th>Description</th> <th>Qty</th> <th>UOM</th> </tr> </thead> <tbody> <tr> <td>V11996A0</td> <td>M5X35 SCREW</td> <td>3</td> <td>PZ</td> </tr> <tr> <td>VM2259A1</td> <td>6 SERIES DOOR LOWER LEFT CAP</td> <td>1</td> <td>PZ</td> </tr> <tr> <td>VM2305A0</td> <td>6 SERIES DOOR CAP FIXING PAWL</td> <td>3</td> <td>PZ</td> </tr> </tbody> </table>	Code	Description	Qty	UOM	V11996A0	M5X35 SCREW	3	PZ	VM2259A1	6 SERIES DOOR LOWER LEFT CAP	1	PZ	VM2305A0	6 SERIES DOOR CAP FIXING PAWL	3	PZ																																	
			Code	Description	Qty	UOM																																																
V11996A0	M5X35 SCREW	3	PZ																																																			
VM2259A1	6 SERIES DOOR LOWER LEFT CAP	1	PZ																																																			
VM2305A0	6 SERIES DOOR CAP FIXING PAWL	3	PZ																																																			
K0B1126AR	BAKERTOP MM RIGHT DOOR LOWER BEAM KIT	<table border="1"> <thead> <tr> <th>Code</th> <th>Description</th> <th>Qty</th> <th>UOM</th> </tr> </thead> <tbody> <tr> <td>0B1126A0</td> <td>DOOR LOWER FRAME SHAPE 860 MM</td> <td>1</td> <td>PZ</td> </tr> <tr> <td>RC1200A0</td> <td>ED=4 WIRE D.=0.5 COMPRESSIO N SPRING</td> <td>2</td> <td>PZ</td> </tr> <tr> <td>V11220A1</td> <td>4,2X12 TCB SELF-TAPPIN G SCREW</td> <td>1</td> <td>PZ</td> </tr> <tr> <td>V11996A0</td> <td>M5X35 SCREW</td> <td>7</td> <td>PZ</td> </tr> <tr> <td>VM1794A0</td> <td>250X4.8 PA66 BLACK CLAMP</td> <td>2</td> <td>PZ</td> </tr> <tr> <td>VM2103A0</td> <td>CLAMP LOCK</td> <td>2</td> <td>PZ</td> </tr> <tr> <td>VM2259A1</td> <td>6 SERIES DOOR LOWER LEFT CAP</td> <td>1</td> <td>PZ</td> </tr> <tr> <td>VM2261A1</td> <td>6 SERIES DOOR LOWER RIGHT CAP</td> <td>1</td> <td>PZ</td> </tr> <tr> <td>VM2267A0</td> <td>INTERNAL GLASS LOCKING SYSTEM SLIDER</td> <td>1</td> <td>PZ</td> </tr> <tr> <td>VM2269A0</td> <td>INTERNAL GLASS LOCKING SYSTEM CAP</td> <td>1</td> <td>PZ</td> </tr> <tr> <td>VM2274A0</td> <td>GROOVED BUSHING</td> <td>1</td> <td>PZ</td> </tr> <tr> <td>VM2305A0</td> <td>6 SERIES DOOR CAP FIXING PAWL</td> <td>7</td> <td>PZ</td> </tr> </tbody> </table>	Code	Description	Qty	UOM	0B1126A0	DOOR LOWER FRAME SHAPE 860 MM	1	PZ	RC1200A0	ED=4 WIRE D.=0.5 COMPRESSIO N SPRING	2	PZ	V11220A1	4,2X12 TCB SELF-TAPPIN G SCREW	1	PZ	V11996A0	M5X35 SCREW	7	PZ	VM1794A0	250X4.8 PA66 BLACK CLAMP	2	PZ	VM2103A0	CLAMP LOCK	2	PZ	VM2259A1	6 SERIES DOOR LOWER LEFT CAP	1	PZ	VM2261A1	6 SERIES DOOR LOWER RIGHT CAP	1	PZ	VM2267A0	INTERNAL GLASS LOCKING SYSTEM SLIDER	1	PZ	VM2269A0	INTERNAL GLASS LOCKING SYSTEM CAP	1	PZ	VM2274A0	GROOVED BUSHING	1	PZ	VM2305A0	6 SERIES DOOR CAP FIXING PAWL	7	PZ
Code	Description	Qty	UOM																																																			
0B1126A0	DOOR LOWER FRAME SHAPE 860 MM	1	PZ																																																			
RC1200A0	ED=4 WIRE D.=0.5 COMPRESSIO N SPRING	2	PZ																																																			
V11220A1	4,2X12 TCB SELF-TAPPIN G SCREW	1	PZ																																																			
V11996A0	M5X35 SCREW	7	PZ																																																			
VM1794A0	250X4.8 PA66 BLACK CLAMP	2	PZ																																																			
VM2103A0	CLAMP LOCK	2	PZ																																																			
VM2259A1	6 SERIES DOOR LOWER LEFT CAP	1	PZ																																																			
VM2261A1	6 SERIES DOOR LOWER RIGHT CAP	1	PZ																																																			
VM2267A0	INTERNAL GLASS LOCKING SYSTEM SLIDER	1	PZ																																																			
VM2269A0	INTERNAL GLASS LOCKING SYSTEM CAP	1	PZ																																																			
VM2274A0	GROOVED BUSHING	1	PZ																																																			
VM2305A0	6 SERIES DOOR CAP FIXING PAWL	7	PZ																																																			
K0B1126AL	BAKERTOP MM LEFT DOOR LOWER BEAM KIT	<table border="1"> <thead> <tr> <th>Code</th> <th>Description</th> <th>Qty</th> <th>UOM</th> </tr> </thead> <tbody> <tr> <td>0B1126A0</td> <td>DOOR LOWER FRAME SHAPE 860 MM</td> <td>1</td> <td>PZ</td> </tr> <tr> <td>RC1200A0</td> <td>ED=4 WIRE D.=0.5 COMPRESSIO N SPRING</td> <td>2</td> <td>PZ</td> </tr> <tr> <td>V11220A1</td> <td>4,2X12 TCB SELF-TAPPIN G SCREW</td> <td>1</td> <td>PZ</td> </tr> </tbody> </table>	Code	Description	Qty	UOM	0B1126A0	DOOR LOWER FRAME SHAPE 860 MM	1	PZ	RC1200A0	ED=4 WIRE D.=0.5 COMPRESSIO N SPRING	2	PZ	V11220A1	4,2X12 TCB SELF-TAPPIN G SCREW	1	PZ																																				
Code	Description	Qty	UOM																																																			
0B1126A0	DOOR LOWER FRAME SHAPE 860 MM	1	PZ																																																			
RC1200A0	ED=4 WIRE D.=0.5 COMPRESSIO N SPRING	2	PZ																																																			
V11220A1	4,2X12 TCB SELF-TAPPIN G SCREW	1	PZ																																																			



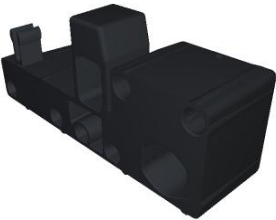

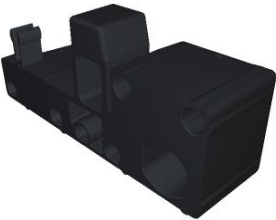
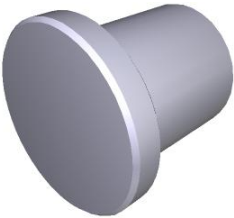

COMPONENT			SPARE PART																																											
Code	Description	Image	Code	Description	Components list																																									
VM2259A	6 SERIES DOOR LOWER LEFT CAP		K0B1126AL	BAKERTOP MM LEFT DOOR LOWER BEAM KIT	<table border="1"> <thead> <tr> <th>Code</th> <th>Description</th> <th>Qty</th> <th>UOM</th> </tr> </thead> <tbody> <tr> <td>VI1996A0</td> <td>M5X35 SCREW</td> <td>7</td> <td>PZ</td> </tr> <tr> <td>VM1794A0</td> <td>250X4.8 PA66 BLACK CLAMP</td> <td>2</td> <td>PZ</td> </tr> <tr> <td>VM2103A0</td> <td>CLAMP LOCK</td> <td>2</td> <td>PZ</td> </tr> <tr> <td>VM2267A0</td> <td>INTERNAL GLASS LOCKING SYSTEM SLIDER</td> <td>1</td> <td>PZ</td> </tr> <tr> <td>VM2269A0</td> <td>INTERNAL GLASS LOCKING SYSTEM CAP</td> <td>1</td> <td>PZ</td> </tr> <tr> <td>VM2274A0</td> <td>GROOVED BUSHING</td> <td>1</td> <td>PZ</td> </tr> <tr> <td>VM2305A0</td> <td>6 SERIES DOOR CAP FIXING PAWL</td> <td>7</td> <td>PZ</td> </tr> <tr> <td>VM2384A0</td> <td>LEFT MM DOOR LOWER RIGHT CAP</td> <td>1</td> <td>PZ</td> </tr> <tr> <td>VM2386A1</td> <td>LEFT MM DOOR LOWER LEFT CAP</td> <td>1</td> <td>PZ</td> </tr> </tbody> </table>	Code	Description	Qty	UOM	VI1996A0	M5X35 SCREW	7	PZ	VM1794A0	250X4.8 PA66 BLACK CLAMP	2	PZ	VM2103A0	CLAMP LOCK	2	PZ	VM2267A0	INTERNAL GLASS LOCKING SYSTEM SLIDER	1	PZ	VM2269A0	INTERNAL GLASS LOCKING SYSTEM CAP	1	PZ	VM2274A0	GROOVED BUSHING	1	PZ	VM2305A0	6 SERIES DOOR CAP FIXING PAWL	7	PZ	VM2384A0	LEFT MM DOOR LOWER RIGHT CAP	1	PZ	VM2386A1	LEFT MM DOOR LOWER LEFT CAP	1	PZ	
			Code	Description	Qty	UOM																																								
VI1996A0	M5X35 SCREW	7	PZ																																											
VM1794A0	250X4.8 PA66 BLACK CLAMP	2	PZ																																											
VM2103A0	CLAMP LOCK	2	PZ																																											
VM2267A0	INTERNAL GLASS LOCKING SYSTEM SLIDER	1	PZ																																											
VM2269A0	INTERNAL GLASS LOCKING SYSTEM CAP	1	PZ																																											
VM2274A0	GROOVED BUSHING	1	PZ																																											
VM2305A0	6 SERIES DOOR CAP FIXING PAWL	7	PZ																																											
VM2384A0	LEFT MM DOOR LOWER RIGHT CAP	1	PZ																																											
VM2386A1	LEFT MM DOOR LOWER LEFT CAP	1	PZ																																											
K0B1122AR	CHEFTOP MM RIGHT DOOR LOWER BEAM KIT	<table border="1"> <thead> <tr> <th>Code</th> <th>Description</th> <th>Qty</th> <th>UOM</th> </tr> </thead> <tbody> <tr> <td>0B1122A0</td> <td>6 SERIES DOOR LOWER FRAME SHAPE</td> <td>1</td> <td>PZ</td> </tr> <tr> <td>RC1200A0</td> <td>ED=4 WIRE D.=0.5 COMPRESSION N SPRING</td> <td>2</td> <td>PZ</td> </tr> <tr> <td>VI1220A1</td> <td>4,2X12 TCB SELF-TAPPIN G SCREW</td> <td>1</td> <td>PZ</td> </tr> <tr> <td>VI1996A0</td> <td>M5X35 SCREW</td> <td>7</td> <td>PZ</td> </tr> <tr> <td>VM1794A0</td> <td>250X4.8 PA66 BLACK CLAMP</td> <td>2</td> <td>PZ</td> </tr> <tr> <td>VM2103A0</td> <td>CLAMP LOCK</td> <td>2</td> <td>PZ</td> </tr> <tr> <td>VM2259A1</td> <td>6 SERIES DOOR LOWER LEFT CAP</td> <td>1</td> <td>PZ</td> </tr> <tr> <td>VM2261A1</td> <td>6 SERIES DOOR LOWER RIGHT CAP</td> <td>1</td> <td>PZ</td> </tr> <tr> <td>VM2267A0</td> <td>INTERNAL GLASS LOCKING SYSTEM SLIDER</td> <td>1</td> <td>PZ</td> </tr> <tr> <td>VM2269A0</td> <td>INTERNAL GLASS LOCKING SYSTEM CAP</td> <td>1</td> <td>PZ</td> </tr> </tbody> </table>	Code	Description	Qty	UOM	0B1122A0	6 SERIES DOOR LOWER FRAME SHAPE	1	PZ	RC1200A0	ED=4 WIRE D.=0.5 COMPRESSION N SPRING	2	PZ	VI1220A1	4,2X12 TCB SELF-TAPPIN G SCREW	1	PZ	VI1996A0	M5X35 SCREW	7	PZ	VM1794A0	250X4.8 PA66 BLACK CLAMP	2	PZ	VM2103A0	CLAMP LOCK	2	PZ	VM2259A1	6 SERIES DOOR LOWER LEFT CAP	1	PZ	VM2261A1	6 SERIES DOOR LOWER RIGHT CAP	1	PZ	VM2267A0	INTERNAL GLASS LOCKING SYSTEM SLIDER	1	PZ	VM2269A0	INTERNAL GLASS LOCKING SYSTEM CAP	1	PZ
Code	Description	Qty	UOM																																											
0B1122A0	6 SERIES DOOR LOWER FRAME SHAPE	1	PZ																																											
RC1200A0	ED=4 WIRE D.=0.5 COMPRESSION N SPRING	2	PZ																																											
VI1220A1	4,2X12 TCB SELF-TAPPIN G SCREW	1	PZ																																											
VI1996A0	M5X35 SCREW	7	PZ																																											
VM1794A0	250X4.8 PA66 BLACK CLAMP	2	PZ																																											
VM2103A0	CLAMP LOCK	2	PZ																																											
VM2259A1	6 SERIES DOOR LOWER LEFT CAP	1	PZ																																											
VM2261A1	6 SERIES DOOR LOWER RIGHT CAP	1	PZ																																											
VM2267A0	INTERNAL GLASS LOCKING SYSTEM SLIDER	1	PZ																																											
VM2269A0	INTERNAL GLASS LOCKING SYSTEM CAP	1	PZ																																											

COMPONENT			SPARE PART																																																			
Code	Description	Image	Code	Description	Components list																																																	
VM2259A	6 SERIES DOOR LOWER LEFT CAP		K0B1122AR	CHEFTOP MM RIGHT DOOR LOWER BEAM KIT	<table border="1"> <thead> <tr> <th>Code</th> <th>Description</th> <th>Qty</th> <th>UOM</th> </tr> </thead> <tbody> <tr> <td>VM2274A0</td> <td>GROOVED BUSHING</td> <td>1</td> <td>PZ</td> </tr> <tr> <td>VM2305A0</td> <td>6 SERIES DOOR CAP FIXING PAWL</td> <td>7</td> <td>PZ</td> </tr> </tbody> </table>	Code	Description	Qty	UOM	VM2274A0	GROOVED BUSHING	1	PZ	VM2305A0	6 SERIES DOOR CAP FIXING PAWL	7	PZ																																					
			Code	Description	Qty	UOM																																																
VM2274A0	GROOVED BUSHING	1	PZ																																																			
VM2305A0	6 SERIES DOOR CAP FIXING PAWL	7	PZ																																																			
K0B1122AL	CHEFTOP MM LEFT DOOR LOWER BEAM KIT	<table border="1"> <thead> <tr> <th>Code</th> <th>Description</th> <th>Qty</th> <th>UOM</th> </tr> </thead> <tbody> <tr> <td>0B1122A0</td> <td>6 SERIES DOOR LOWER FRAME SHAPE</td> <td>1</td> <td>PZ</td> </tr> <tr> <td>RC1200A0</td> <td>ED=4 WIRE D.=0.5 COMPRESSION N SPRING</td> <td>2</td> <td>PZ</td> </tr> <tr> <td>V11220A1</td> <td>4,2X12 TCB SELF-TAPPING G SCREW</td> <td>1</td> <td>PZ</td> </tr> <tr> <td>V11996A0</td> <td>MSX35 SCREW</td> <td>7</td> <td>PZ</td> </tr> <tr> <td>VM1794A0</td> <td>250X4.8 PA66 BLACK CLAMP</td> <td>2</td> <td>PZ</td> </tr> <tr> <td>VM2103A0</td> <td>CLAMP LOCK</td> <td>2</td> <td>PZ</td> </tr> <tr> <td>VM2267A0</td> <td>INTERNAL GLASS LOCKING SYSTEM SLIDER</td> <td>1</td> <td>PZ</td> </tr> <tr> <td>VM2269A0</td> <td>INTERNAL GLASS LOCKING SYSTEM CAP</td> <td>1</td> <td>PZ</td> </tr> <tr> <td>VM2274A0</td> <td>GROOVED BUSHING</td> <td>1</td> <td>PZ</td> </tr> <tr> <td>VM2305A0</td> <td>6 SERIES DOOR CAP FIXING PAWL</td> <td>7</td> <td>PZ</td> </tr> <tr> <td>VM2384A0</td> <td>LEFT MM DOOR LOWER RIGHT CAP</td> <td>1</td> <td>PZ</td> </tr> <tr> <td>VM2386A1</td> <td>LEFT MM DOOR LOWER LEFT CAP</td> <td>1</td> <td>PZ</td> </tr> </tbody> </table>	Code	Description	Qty	UOM	0B1122A0	6 SERIES DOOR LOWER FRAME SHAPE	1	PZ	RC1200A0	ED=4 WIRE D.=0.5 COMPRESSION N SPRING	2	PZ	V11220A1	4,2X12 TCB SELF-TAPPING G SCREW	1	PZ	V11996A0	MSX35 SCREW	7	PZ	VM1794A0	250X4.8 PA66 BLACK CLAMP	2	PZ	VM2103A0	CLAMP LOCK	2	PZ	VM2267A0	INTERNAL GLASS LOCKING SYSTEM SLIDER	1	PZ	VM2269A0	INTERNAL GLASS LOCKING SYSTEM CAP	1	PZ	VM2274A0	GROOVED BUSHING	1	PZ	VM2305A0	6 SERIES DOOR CAP FIXING PAWL	7	PZ	VM2384A0	LEFT MM DOOR LOWER RIGHT CAP	1	PZ	VM2386A1	LEFT MM DOOR LOWER LEFT CAP	1	PZ
Code	Description	Qty	UOM																																																			
0B1122A0	6 SERIES DOOR LOWER FRAME SHAPE	1	PZ																																																			
RC1200A0	ED=4 WIRE D.=0.5 COMPRESSION N SPRING	2	PZ																																																			
V11220A1	4,2X12 TCB SELF-TAPPING G SCREW	1	PZ																																																			
V11996A0	MSX35 SCREW	7	PZ																																																			
VM1794A0	250X4.8 PA66 BLACK CLAMP	2	PZ																																																			
VM2103A0	CLAMP LOCK	2	PZ																																																			
VM2267A0	INTERNAL GLASS LOCKING SYSTEM SLIDER	1	PZ																																																			
VM2269A0	INTERNAL GLASS LOCKING SYSTEM CAP	1	PZ																																																			
VM2274A0	GROOVED BUSHING	1	PZ																																																			
VM2305A0	6 SERIES DOOR CAP FIXING PAWL	7	PZ																																																			
VM2384A0	LEFT MM DOOR LOWER RIGHT CAP	1	PZ																																																			
VM2386A1	LEFT MM DOOR LOWER LEFT CAP	1	PZ																																																			
VM2305A	6 SERIES DOOR CAP FIXING PAWL		KVM2305A	MM FIXING DOOR THUB SCREWS 10 PCS KIT	<table border="1"> <thead> <tr> <th>Code</th> <th>Description</th> <th>Qty</th> <th>UOM</th> </tr> </thead> <tbody> <tr> <td>VM2305A0</td> <td>6 SERIES DOOR CAP FIXING PAWL</td> <td>10</td> <td>PZ</td> </tr> </tbody> </table>	Code	Description	Qty	UOM	VM2305A0	6 SERIES DOOR CAP FIXING PAWL	10	PZ																																									
Code	Description	Qty	UOM																																																			
VM2305A0	6 SERIES DOOR CAP FIXING PAWL	10	PZ																																																			

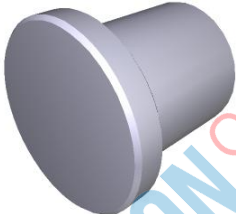
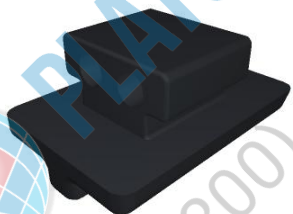
COMPONENT			SPARE PART										
Code	Description	Image	Code	Description	Components list								
VM2267A	INTERNAL GLASS LOCKING SYSTEM SLIDER		VM2267A0	INTERNAL GLASS LOCKING SYSTEM SLIDER									
VM2269A	INTERNAL GLASS LOCKING SYSTEM CAP		KVM2269A	INNER GLASS FIXING CAP KIT	<table border="1"> <thead> <tr> <th>Code</th> <th>Description</th> <th>Qty</th> <th>UOM</th> </tr> </thead> <tbody> <tr> <td>VM2269A0</td> <td>INTERNAL GLASS LOCKING SYSTEM CAP</td> <td>2</td> <td>PZ</td> </tr> </tbody> </table>	Code	Description	Qty	UOM	VM2269A0	INTERNAL GLASS LOCKING SYSTEM CAP	2	PZ
Code	Description	Qty	UOM										
VM2269A0	INTERNAL GLASS LOCKING SYSTEM CAP	2	PZ										
VE1030A	MAGNET FOR DOOR MICROSWITCH D=22,9MM		KVE1030A	2 PCS MAGNET KIT FOR DOOR SWITCH	<table border="1"> <thead> <tr> <th>Code</th> <th>Description</th> <th>Qty</th> <th>UOM</th> </tr> </thead> <tbody> <tr> <td>VE1030A1</td> <td>MAGNET FOR DOOR MICROSWITCH H D=22,9MM</td> <td>2</td> <td>PZ</td> </tr> </tbody> </table>	Code	Description	Qty	UOM	VE1030A1	MAGNET FOR DOOR MICROSWITCH H D=22,9MM	2	PZ
Code	Description	Qty	UOM										
VE1030A1	MAGNET FOR DOOR MICROSWITCH H D=22,9MM	2	PZ										
			KVE1020A	MICROSWITCH KIT	<table border="1"> <thead> <tr> <th>Code</th> <th>Description</th> <th>Qty</th> <th>UOM</th> </tr> </thead> <tbody> <tr> <td>VE1020A2</td> <td>MAGNETIC DOOR MICROSWITCH</td> <td>1</td> <td>PZ</td> </tr> </tbody> </table>	Code	Description	Qty	UOM	VE1020A2	MAGNETIC DOOR MICROSWITCH	1	PZ
Code	Description	Qty	UOM										
VE1020A2	MAGNETIC DOOR MICROSWITCH	1	PZ										
			VE1030A1	MAGNET FOR DOOR MICROSWITCH H D=22,9MM	<table border="1"> <thead> <tr> <th>Code</th> <th>Description</th> <th>Qty</th> <th>UOM</th> </tr> </thead> <tbody> <tr> <td>VE1030A1</td> <td>MAGNET FOR DOOR MICROSWITCH H D=22,9MM</td> <td>4</td> <td>PZ</td> </tr> </tbody> </table>	Code	Description	Qty	UOM	VE1030A1	MAGNET FOR DOOR MICROSWITCH H D=22,9MM	4	PZ
Code	Description	Qty	UOM										
VE1030A1	MAGNET FOR DOOR MICROSWITCH H D=22,9MM	4	PZ										
VM2268A	DOOR MAGNET COVER		KVM2268A	DOOR MAGNET COVER KIT	<table border="1"> <thead> <tr> <th>Code</th> <th>Description</th> <th>Qty</th> <th>UOM</th> </tr> </thead> <tbody> <tr> <td>VM2268A0</td> <td>DOOR MAGNET COVER</td> <td>1</td> <td>PZ</td> </tr> </tbody> </table>	Code	Description	Qty	UOM	VM2268A0	DOOR MAGNET COVER	1	PZ
Code	Description	Qty	UOM										
VM2268A0	DOOR MAGNET COVER	1	PZ										
VI1996A	M5X35 SCREW		VI1996A0	M5X35 SCREW									

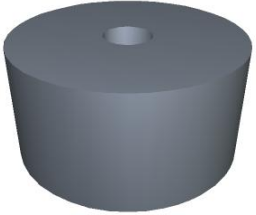

COMPONENT			SPARE PART										
Code	Description	Image	Code	Description	Components list								
VM2262A	6 SERIES DOOR UPPER RIGHT CAP		KVM2262A	MIND.MAPS DOOR RIGHT UPPER CAP KIT	<table border="1"> <thead> <tr> <th>Code</th> <th>Description</th> <th>Qty</th> <th>UOM</th> </tr> </thead> <tbody> <tr> <td>VM2262A1</td> <td>6 SERIES DOOR UPPER RIGHT CAP</td> <td>1</td> <td>PZ</td> </tr> </tbody> </table>	Code	Description	Qty	UOM	VM2262A1	6 SERIES DOOR UPPER RIGHT CAP	1	PZ
Code	Description	Qty	UOM										
VM2262A1	6 SERIES DOOR UPPER RIGHT CAP	1	PZ										
VM2305A	6 SERIES DOOR CAP FIXING PAWL		KVM2305A	MM FIXING DOOR THUB SCREWS 10 PCS KIT	<table border="1"> <thead> <tr> <th>Code</th> <th>Description</th> <th>Qty</th> <th>UOM</th> </tr> </thead> <tbody> <tr> <td>VM2305A0</td> <td>6 SERIES DOOR CAP FIXING PAWL</td> <td>10</td> <td>PZ</td> </tr> </tbody> </table>	Code	Description	Qty	UOM	VM2305A0	6 SERIES DOOR CAP FIXING PAWL	10	PZ
Code	Description	Qty	UOM										
VM2305A0	6 SERIES DOOR CAP FIXING PAWL	10	PZ										
VM2267A	INTERNAL GLASS LOCKING SYSTEM SLIDER		VM2267A0	INTERNAL GLASS LOCKING SYSTEM SLIDER									
VM2269A	INTERNAL GLASS LOCKING SYSTEM CAP		KVM2269A	INNER GLASS FIXING CAP KIT	<table border="1"> <thead> <tr> <th>Code</th> <th>Description</th> <th>Qty</th> <th>UOM</th> </tr> </thead> <tbody> <tr> <td>VM2269A0</td> <td>INTERNAL GLASS LOCKING SYSTEM CAP</td> <td>2</td> <td>PZ</td> </tr> </tbody> </table>	Code	Description	Qty	UOM	VM2269A0	INTERNAL GLASS LOCKING SYSTEM CAP	2	PZ
Code	Description	Qty	UOM										
VM2269A0	INTERNAL GLASS LOCKING SYSTEM CAP	2	PZ										
VE1030A	MAGNET FOR DOOR MICROSWITCH D=22,9MM		KVE1030A	2 PCS MAGNET KIT FOR DOOR SWITCH	<table border="1"> <thead> <tr> <th>Code</th> <th>Description</th> <th>Qty</th> <th>UOM</th> </tr> </thead> <tbody> <tr> <td>VE1030A1</td> <td>MAGNET FOR DOOR MICROSWITCH H D=22,9MM</td> <td>2</td> <td>PZ</td> </tr> </tbody> </table>	Code	Description	Qty	UOM	VE1030A1	MAGNET FOR DOOR MICROSWITCH H D=22,9MM	2	PZ
Code	Description	Qty	UOM										
VE1030A1	MAGNET FOR DOOR MICROSWITCH H D=22,9MM	2	PZ										
			KVE1020A	MICROSWITCH KIT	<table border="1"> <thead> <tr> <th>Code</th> <th>Description</th> <th>Qty</th> <th>UOM</th> </tr> </thead> <tbody> <tr> <td>VE1020A2</td> <td>MAGNETIC DOOR MICROSWITCH</td> <td>1</td> <td>PZ</td> </tr> </tbody> </table>	Code	Description	Qty	UOM	VE1020A2	MAGNETIC DOOR MICROSWITCH	1	PZ
Code	Description	Qty	UOM										
VE1020A2	MAGNETIC DOOR MICROSWITCH	1	PZ										
					<table border="1"> <thead> <tr> <th>Code</th> <th>Description</th> <th>Qty</th> <th>UOM</th> </tr> </thead> <tbody> <tr> <td>VE1030A1</td> <td>MAGNET FOR DOOR MICROSWITCH H D=22,9MM</td> <td>4</td> <td>PZ</td> </tr> </tbody> </table>	Code	Description	Qty	UOM	VE1030A1	MAGNET FOR DOOR MICROSWITCH H D=22,9MM	4	PZ
Code	Description	Qty	UOM										
VE1030A1	MAGNET FOR DOOR MICROSWITCH H D=22,9MM	4	PZ										

COMPONENT			SPARE PART																																																										
Code	Description	Image	Code	Description	Components list																																																								
VM2268A	DOOR MAGNET COVER		KVM2268A	DOOR MAGNET COVER KIT	<table border="1"> <thead> <tr> <th>Code</th> <th>Description</th> <th>Qty</th> <th>UOM</th> </tr> </thead> <tbody> <tr> <td>VM2268A0</td> <td>DOOR MAGNET COVER</td> <td>1</td> <td>PZ</td> </tr> </tbody> </table>	Code	Description	Qty	UOM	VM2268A0	DOOR MAGNET COVER	1	PZ																																																
Code	Description	Qty	UOM																																																										
VM2268A0	DOOR MAGNET COVER	1	PZ																																																										
VI1996A	M5X35 SCREW		VI1996A0	M5X35 SCREW																																																									
VM2261A	6 SERIES DOOR LOWER RIGHT CAP		<p>KVM2261A</p> <p>K0B1126AR</p>	<p>MIND.MAPS DOOR RIGHT LOWER CAP KIT</p> <p>BAKERTOP MM RIGHT DOOR LOWER BEAM KIT</p>	<table border="1"> <thead> <tr> <th>Code</th> <th>Description</th> <th>Qty</th> <th>UOM</th> </tr> </thead> <tbody> <tr> <td>VI1996A0</td> <td>M5X35 SCREW</td> <td>3</td> <td>PZ</td> </tr> <tr> <td>VM2261A1</td> <td>6 SERIES DOOR LOWER RIGHT CAP</td> <td>1</td> <td>PZ</td> </tr> <tr> <td>VM2305A0</td> <td>6 SERIES DOOR CAP FIXING PAWL</td> <td>3</td> <td>PZ</td> </tr> </tbody> </table> <table border="1"> <thead> <tr> <th>Code</th> <th>Description</th> <th>Qty</th> <th>UOM</th> </tr> </thead> <tbody> <tr> <td>0B1126A0</td> <td>DOOR LOWER FRAME SHAPE 860 MM</td> <td>1</td> <td>PZ</td> </tr> <tr> <td>RC1200A0</td> <td>ED=4 WIRE D.=0.5 COMPRESSIO N SPRING</td> <td>2</td> <td>PZ</td> </tr> <tr> <td>VI1220A1</td> <td>4,2X12 TCB SELF-TAPPIN G SCREW</td> <td>1</td> <td>PZ</td> </tr> <tr> <td>VI1996A0</td> <td>M5X35 SCREW</td> <td>7</td> <td>PZ</td> </tr> <tr> <td>VM1794A0</td> <td>250X4.8 PA66 BLACK CLAMP</td> <td>2</td> <td>PZ</td> </tr> <tr> <td>VM2103A0</td> <td>CLAMP LOCK</td> <td>2</td> <td>PZ</td> </tr> <tr> <td>VM2259A1</td> <td>6 SERIES DOOR LOWER LEFT CAP</td> <td>1</td> <td>PZ</td> </tr> <tr> <td>VM2261A1</td> <td>6 SERIES DOOR LOWER RIGHT CAP</td> <td>1</td> <td>PZ</td> </tr> <tr> <td>VM2267A0</td> <td>INTERNAL GLASS LOCKING SYSTEM SLIDER</td> <td>1</td> <td>PZ</td> </tr> </tbody> </table>	Code	Description	Qty	UOM	VI1996A0	M5X35 SCREW	3	PZ	VM2261A1	6 SERIES DOOR LOWER RIGHT CAP	1	PZ	VM2305A0	6 SERIES DOOR CAP FIXING PAWL	3	PZ	Code	Description	Qty	UOM	0B1126A0	DOOR LOWER FRAME SHAPE 860 MM	1	PZ	RC1200A0	ED=4 WIRE D.=0.5 COMPRESSIO N SPRING	2	PZ	VI1220A1	4,2X12 TCB SELF-TAPPIN G SCREW	1	PZ	VI1996A0	M5X35 SCREW	7	PZ	VM1794A0	250X4.8 PA66 BLACK CLAMP	2	PZ	VM2103A0	CLAMP LOCK	2	PZ	VM2259A1	6 SERIES DOOR LOWER LEFT CAP	1	PZ	VM2261A1	6 SERIES DOOR LOWER RIGHT CAP	1	PZ	VM2267A0	INTERNAL GLASS LOCKING SYSTEM SLIDER	1	PZ
Code	Description	Qty	UOM																																																										
VI1996A0	M5X35 SCREW	3	PZ																																																										
VM2261A1	6 SERIES DOOR LOWER RIGHT CAP	1	PZ																																																										
VM2305A0	6 SERIES DOOR CAP FIXING PAWL	3	PZ																																																										
Code	Description	Qty	UOM																																																										
0B1126A0	DOOR LOWER FRAME SHAPE 860 MM	1	PZ																																																										
RC1200A0	ED=4 WIRE D.=0.5 COMPRESSIO N SPRING	2	PZ																																																										
VI1220A1	4,2X12 TCB SELF-TAPPIN G SCREW	1	PZ																																																										
VI1996A0	M5X35 SCREW	7	PZ																																																										
VM1794A0	250X4.8 PA66 BLACK CLAMP	2	PZ																																																										
VM2103A0	CLAMP LOCK	2	PZ																																																										
VM2259A1	6 SERIES DOOR LOWER LEFT CAP	1	PZ																																																										
VM2261A1	6 SERIES DOOR LOWER RIGHT CAP	1	PZ																																																										
VM2267A0	INTERNAL GLASS LOCKING SYSTEM SLIDER	1	PZ																																																										





COMPONENT			SPARE PART																																																			
Code	Description	Image	Code	Description	Components list																																																	
VM2261A	6 SERIES DOOR LOWER RIGHT CAP		K0B1126AR	BAKERTOP MM RIGHT DOOR LOWER BEAM KIT	<table border="1"> <thead> <tr> <th>Code</th> <th>Description</th> <th>Qty</th> <th>UOM</th> </tr> </thead> <tbody> <tr> <td>VM2269A0</td> <td>INTERNAL GLASS LOCKING SYSTEM CAP</td> <td>1</td> <td>PZ</td> </tr> <tr> <td>VM2274A0</td> <td>GROOVED BUSHING</td> <td>1</td> <td>PZ</td> </tr> <tr> <td>VM2305A0</td> <td>6 SERIES DOOR CAP FIXING PAWL</td> <td>7</td> <td>PZ</td> </tr> </tbody> </table>	Code	Description	Qty	UOM	VM2269A0	INTERNAL GLASS LOCKING SYSTEM CAP	1	PZ	VM2274A0	GROOVED BUSHING	1	PZ	VM2305A0	6 SERIES DOOR CAP FIXING PAWL	7	PZ																																	
			Code	Description	Qty	UOM																																																
VM2269A0	INTERNAL GLASS LOCKING SYSTEM CAP	1	PZ																																																			
VM2274A0	GROOVED BUSHING	1	PZ																																																			
VM2305A0	6 SERIES DOOR CAP FIXING PAWL	7	PZ																																																			
K0B1126AL	BAKERTOP MM LEFT DOOR LOWER BEAM KIT	<table border="1"> <thead> <tr> <th>Code</th> <th>Description</th> <th>Qty</th> <th>UOM</th> </tr> </thead> <tbody> <tr> <td>0B1126A0</td> <td>DOOR LOWER FRAME SHAPE 860 MM</td> <td>1</td> <td>PZ</td> </tr> <tr> <td>RC1200A0</td> <td>ED=4 WIRE D.=0.5 COMPRESSIO N SPRING</td> <td>2</td> <td>PZ</td> </tr> <tr> <td>VH1220A1</td> <td>4,2X12 TCB SELF-TAPPIN G SCREW</td> <td>1</td> <td>PZ</td> </tr> <tr> <td>VI1996A0</td> <td>M5X35 SCREW</td> <td>7</td> <td>PZ</td> </tr> <tr> <td>VM1794A0</td> <td>250X4.8 PA66 BLACK CLAMP</td> <td>2</td> <td>PZ</td> </tr> <tr> <td>VM2103A0</td> <td>CLAMP LOCK</td> <td>2</td> <td>PZ</td> </tr> <tr> <td>VM2267A0</td> <td>INTERNAL GLASS LOCKING SYSTEM SLIDER</td> <td>1</td> <td>PZ</td> </tr> <tr> <td>VM2269A0</td> <td>INTERNAL GLASS LOCKING SYSTEM CAP</td> <td>1</td> <td>PZ</td> </tr> <tr> <td>VM2274A0</td> <td>GROOVED BUSHING</td> <td>1</td> <td>PZ</td> </tr> <tr> <td>VM2305A0</td> <td>6 SERIES DOOR CAP FIXING PAWL</td> <td>7</td> <td>PZ</td> </tr> <tr> <td>VM2384A0</td> <td>LEFT MM DOOR LOWER RIGHT CAP</td> <td>1</td> <td>PZ</td> </tr> <tr> <td>VM2386A1</td> <td>LEFT MM DOOR LOWER LEFT CAP</td> <td>1</td> <td>PZ</td> </tr> </tbody> </table>	Code	Description	Qty	UOM	0B1126A0	DOOR LOWER FRAME SHAPE 860 MM	1	PZ	RC1200A0	ED=4 WIRE D.=0.5 COMPRESSIO N SPRING	2	PZ	VH1220A1	4,2X12 TCB SELF-TAPPIN G SCREW	1	PZ	VI1996A0	M5X35 SCREW	7	PZ	VM1794A0	250X4.8 PA66 BLACK CLAMP	2	PZ	VM2103A0	CLAMP LOCK	2	PZ	VM2267A0	INTERNAL GLASS LOCKING SYSTEM SLIDER	1	PZ	VM2269A0	INTERNAL GLASS LOCKING SYSTEM CAP	1	PZ	VM2274A0	GROOVED BUSHING	1	PZ	VM2305A0	6 SERIES DOOR CAP FIXING PAWL	7	PZ	VM2384A0	LEFT MM DOOR LOWER RIGHT CAP	1	PZ	VM2386A1	LEFT MM DOOR LOWER LEFT CAP	1	PZ
Code	Description	Qty	UOM																																																			
0B1126A0	DOOR LOWER FRAME SHAPE 860 MM	1	PZ																																																			
RC1200A0	ED=4 WIRE D.=0.5 COMPRESSIO N SPRING	2	PZ																																																			
VH1220A1	4,2X12 TCB SELF-TAPPIN G SCREW	1	PZ																																																			
VI1996A0	M5X35 SCREW	7	PZ																																																			
VM1794A0	250X4.8 PA66 BLACK CLAMP	2	PZ																																																			
VM2103A0	CLAMP LOCK	2	PZ																																																			
VM2267A0	INTERNAL GLASS LOCKING SYSTEM SLIDER	1	PZ																																																			
VM2269A0	INTERNAL GLASS LOCKING SYSTEM CAP	1	PZ																																																			
VM2274A0	GROOVED BUSHING	1	PZ																																																			
VM2305A0	6 SERIES DOOR CAP FIXING PAWL	7	PZ																																																			
VM2384A0	LEFT MM DOOR LOWER RIGHT CAP	1	PZ																																																			
VM2386A1	LEFT MM DOOR LOWER LEFT CAP	1	PZ																																																			
K0B1122AR	CHEFTOP MM RIGHT DOOR LOWER BEAM KIT	<table border="1"> <thead> <tr> <th>Code</th> <th>Description</th> <th>Qty</th> <th>UOM</th> </tr> </thead> <tbody> <tr> <td>0B1122A0</td> <td>6 SERIES DOOR LOWER FRAME SHAPE</td> <td>1</td> <td>PZ</td> </tr> <tr> <td>RC1200A0</td> <td>ED=4 WIRE D.=0.5 COMPRESSIO N SPRING</td> <td>2</td> <td>PZ</td> </tr> </tbody> </table>	Code	Description	Qty	UOM	0B1122A0	6 SERIES DOOR LOWER FRAME SHAPE	1	PZ	RC1200A0	ED=4 WIRE D.=0.5 COMPRESSIO N SPRING	2	PZ																																								
Code	Description	Qty	UOM																																																			
0B1122A0	6 SERIES DOOR LOWER FRAME SHAPE	1	PZ																																																			
RC1200A0	ED=4 WIRE D.=0.5 COMPRESSIO N SPRING	2	PZ																																																			



COMPONENT			SPARE PART																																														
Code	Description	Image	Code	Description	Components list																																												
VM2261A	6 SERIES DOOR LOWER RIGHT CAP		K0B1122AR	CHEFTOP MM RIGHT DOOR LOWER BEAM KIT	<table border="1"> <thead> <tr> <th>Code</th> <th>Description</th> <th>Qty</th> <th>UOM</th> </tr> </thead> <tbody> <tr> <td>VI1220A1</td> <td>4,2X12 TCB SELF-TAPPIN G SCREW</td> <td>1</td> <td>PZ</td> </tr> <tr> <td>VI1996A0</td> <td>M5X35 SCREW</td> <td>7</td> <td>PZ</td> </tr> <tr> <td>VM1794A0</td> <td>250X4.8 PA66 BLACK CLAMP</td> <td>2</td> <td>PZ</td> </tr> <tr> <td>VM2103A0</td> <td>CLAMP LOCK</td> <td>2</td> <td>PZ</td> </tr> <tr> <td>VM2259A1</td> <td>6 SERIES DOOR LOWER LEFT CAP</td> <td>1</td> <td>PZ</td> </tr> <tr> <td>VM2261A1</td> <td>6 SERIES DOOR LOWER RIGHT CAP</td> <td>1</td> <td>PZ</td> </tr> <tr> <td>VM2267A0</td> <td>INTERNAL GLASS LOCKING SYSTEM SLIDER</td> <td>1</td> <td>PZ</td> </tr> <tr> <td>VM2269A0</td> <td>INTERNAL GLASS LOCKING SYSTEM CAP</td> <td>1</td> <td>PZ</td> </tr> <tr> <td>VM2274A0</td> <td>GROOVED BUSHING</td> <td>1</td> <td>PZ</td> </tr> <tr> <td>VM2305A0</td> <td>6 SERIES DOOR CAP FIXING PAWL</td> <td>7</td> <td>PZ</td> </tr> </tbody> </table>	Code	Description	Qty	UOM	VI1220A1	4,2X12 TCB SELF-TAPPIN G SCREW	1	PZ	VI1996A0	M5X35 SCREW	7	PZ	VM1794A0	250X4.8 PA66 BLACK CLAMP	2	PZ	VM2103A0	CLAMP LOCK	2	PZ	VM2259A1	6 SERIES DOOR LOWER LEFT CAP	1	PZ	VM2261A1	6 SERIES DOOR LOWER RIGHT CAP	1	PZ	VM2267A0	INTERNAL GLASS LOCKING SYSTEM SLIDER	1	PZ	VM2269A0	INTERNAL GLASS LOCKING SYSTEM CAP	1	PZ	VM2274A0	GROOVED BUSHING	1	PZ	VM2305A0	6 SERIES DOOR CAP FIXING PAWL	7	PZ
			Code	Description	Qty	UOM																																											
VI1220A1	4,2X12 TCB SELF-TAPPIN G SCREW	1	PZ																																														
VI1996A0	M5X35 SCREW	7	PZ																																														
VM1794A0	250X4.8 PA66 BLACK CLAMP	2	PZ																																														
VM2103A0	CLAMP LOCK	2	PZ																																														
VM2259A1	6 SERIES DOOR LOWER LEFT CAP	1	PZ																																														
VM2261A1	6 SERIES DOOR LOWER RIGHT CAP	1	PZ																																														
VM2267A0	INTERNAL GLASS LOCKING SYSTEM SLIDER	1	PZ																																														
VM2269A0	INTERNAL GLASS LOCKING SYSTEM CAP	1	PZ																																														
VM2274A0	GROOVED BUSHING	1	PZ																																														
VM2305A0	6 SERIES DOOR CAP FIXING PAWL	7	PZ																																														
K0B1122AL	CHEFTOP MM LEFT DOOR LOWER BEAM KIT	<table border="1"> <thead> <tr> <th>Code</th> <th>Description</th> <th>Qty</th> <th>UOM</th> </tr> </thead> <tbody> <tr> <td>0B1122A0</td> <td>6 SERIES DOOR LOWER FRAME SHAPE</td> <td>1</td> <td>PZ</td> </tr> <tr> <td>RC1200A0</td> <td>ED=4 WIRE D.=0.5 COMPRESSIO N SPRING</td> <td>2</td> <td>PZ</td> </tr> <tr> <td>VI1220A1</td> <td>4,2X12 TCB SELF-TAPPIN G SCREW</td> <td>1</td> <td>PZ</td> </tr> <tr> <td>VI1996A0</td> <td>M5X35 SCREW</td> <td>7</td> <td>PZ</td> </tr> <tr> <td>VM1794A0</td> <td>250X4.8 PA66 BLACK CLAMP</td> <td>2</td> <td>PZ</td> </tr> <tr> <td>VM2103A0</td> <td>CLAMP LOCK</td> <td>2</td> <td>PZ</td> </tr> <tr> <td>VM2267A0</td> <td>INTERNAL GLASS LOCKING SYSTEM SLIDER</td> <td>1</td> <td>PZ</td> </tr> <tr> <td>VM2269A0</td> <td>INTERNAL GLASS LOCKING SYSTEM CAP</td> <td>1</td> <td>PZ</td> </tr> <tr> <td>VM2274A0</td> <td>GROOVED BUSHING</td> <td>1</td> <td>PZ</td> </tr> </tbody> </table>	Code	Description	Qty	UOM	0B1122A0	6 SERIES DOOR LOWER FRAME SHAPE	1	PZ	RC1200A0	ED=4 WIRE D.=0.5 COMPRESSIO N SPRING	2	PZ	VI1220A1	4,2X12 TCB SELF-TAPPIN G SCREW	1	PZ	VI1996A0	M5X35 SCREW	7	PZ	VM1794A0	250X4.8 PA66 BLACK CLAMP	2	PZ	VM2103A0	CLAMP LOCK	2	PZ	VM2267A0	INTERNAL GLASS LOCKING SYSTEM SLIDER	1	PZ	VM2269A0	INTERNAL GLASS LOCKING SYSTEM CAP	1	PZ	VM2274A0	GROOVED BUSHING	1	PZ							
Code	Description	Qty	UOM																																														
0B1122A0	6 SERIES DOOR LOWER FRAME SHAPE	1	PZ																																														
RC1200A0	ED=4 WIRE D.=0.5 COMPRESSIO N SPRING	2	PZ																																														
VI1220A1	4,2X12 TCB SELF-TAPPIN G SCREW	1	PZ																																														
VI1996A0	M5X35 SCREW	7	PZ																																														
VM1794A0	250X4.8 PA66 BLACK CLAMP	2	PZ																																														
VM2103A0	CLAMP LOCK	2	PZ																																														
VM2267A0	INTERNAL GLASS LOCKING SYSTEM SLIDER	1	PZ																																														
VM2269A0	INTERNAL GLASS LOCKING SYSTEM CAP	1	PZ																																														
VM2274A0	GROOVED BUSHING	1	PZ																																														

COMPONENT			SPARE PART																		
Code	Description	Image	Code	Description	Components list																
VM2261A	6 SERIES DOOR LOWER RIGHT CAP		K0B1122AL	CHEFTOP MM LEFT DOOR LOWER BEAM KIT	<table border="1"> <thead> <tr> <th>Code</th> <th>Description</th> <th>Qty</th> <th>UOM</th> </tr> </thead> <tbody> <tr> <td>VM2305A0</td> <td>6 SERIES DOOR CAP FIXING PAWL</td> <td>7</td> <td>PZ</td> </tr> <tr> <td>VM2384A0</td> <td>LEFT MM DOOR LOWER RIGHT CAP</td> <td>1</td> <td>PZ</td> </tr> <tr> <td>VM2386A1</td> <td>LEFT MM DOOR LOWER LEFT CAP</td> <td>1</td> <td>PZ</td> </tr> </tbody> </table>	Code	Description	Qty	UOM	VM2305A0	6 SERIES DOOR CAP FIXING PAWL	7	PZ	VM2384A0	LEFT MM DOOR LOWER RIGHT CAP	1	PZ	VM2386A1	LEFT MM DOOR LOWER LEFT CAP	1	PZ
Code	Description	Qty	UOM																		
VM2305A0	6 SERIES DOOR CAP FIXING PAWL	7	PZ																		
VM2384A0	LEFT MM DOOR LOWER RIGHT CAP	1	PZ																		
VM2386A1	LEFT MM DOOR LOWER LEFT CAP	1	PZ																		
VM2315A	MIND.MAPS INTERNAL GLASS CAP SUPPORT		KVM2315A	MM INTERNAL GLASS SUPPORT KI	<table border="1"> <thead> <tr> <th>Code</th> <th>Description</th> <th>Qty</th> <th>UOM</th> </tr> </thead> <tbody> <tr> <td>V11220A1</td> <td>4,2X12 TCB SELF-TAPPIN G SCREW</td> <td>3</td> <td>PZ</td> </tr> <tr> <td>VM1630A0</td> <td>INTERNAL GLASS PUSHING CAP</td> <td>3</td> <td>PZ</td> </tr> <tr> <td>VM2315A0</td> <td>MIND.MAPS INTERNAL GLASS CAP SUPPORT</td> <td>3</td> <td>PZ</td> </tr> </tbody> </table>	Code	Description	Qty	UOM	V11220A1	4,2X12 TCB SELF-TAPPIN G SCREW	3	PZ	VM1630A0	INTERNAL GLASS PUSHING CAP	3	PZ	VM2315A0	MIND.MAPS INTERNAL GLASS CAP SUPPORT	3	PZ
Code	Description	Qty	UOM																		
V11220A1	4,2X12 TCB SELF-TAPPIN G SCREW	3	PZ																		
VM1630A0	INTERNAL GLASS PUSHING CAP	3	PZ																		
VM2315A0	MIND.MAPS INTERNAL GLASS CAP SUPPORT	3	PZ																		
VM1630A	INTERNAL GLASS PUSHING CAP		KVM1630A	CAP FOR INTERNAL GLASS 10 PCS KIT	<table border="1"> <thead> <tr> <th>Code</th> <th>Description</th> <th>Qty</th> <th>UOM</th> </tr> </thead> <tbody> <tr> <td>VM1630A0</td> <td>INTERNAL GLASS PUSHING CAP</td> <td>10</td> <td>PZ</td> </tr> </tbody> </table>	Code	Description	Qty	UOM	VM1630A0	INTERNAL GLASS PUSHING CAP	10	PZ								
Code	Description	Qty	UOM																		
VM1630A0	INTERNAL GLASS PUSHING CAP	10	PZ																		
VM2371A	DOUBLE GLASS DOOR PUSHING BRACKET		KVM2371A	INTERNAL DOUBLE GLASS SUPPORT 3 PCS KIT	<table border="1"> <thead> <tr> <th>Code</th> <th>Description</th> <th>Qty</th> <th>UOM</th> </tr> </thead> <tbody> <tr> <td>V11220A1</td> <td>4,2X12 TCB SELF-TAPPIN G SCREW</td> <td>3</td> <td>PZ</td> </tr> <tr> <td>VM2371A0</td> <td>DOUBLE GLASS DOOR PUSHING BRACKET</td> <td>3</td> <td>PZ</td> </tr> </tbody> </table>	Code	Description	Qty	UOM	V11220A1	4,2X12 TCB SELF-TAPPIN G SCREW	3	PZ	VM2371A0	DOUBLE GLASS DOOR PUSHING BRACKET	3	PZ				
Code	Description	Qty	UOM																		
V11220A1	4,2X12 TCB SELF-TAPPIN G SCREW	3	PZ																		
VM2371A0	DOUBLE GLASS DOOR PUSHING BRACKET	3	PZ																		
VN1177A	CONTROL BOARD COOLING FAN		KVN1177A	CONTROL BOARD COOLING FAN KIT	<table border="1"> <thead> <tr> <th>Code</th> <th>Description</th> <th>Qty</th> <th>UOM</th> </tr> </thead> <tbody> <tr> <td>VN1177A0</td> <td>CONTROL BOARD COOLING FAN</td> <td>1</td> <td>PZ</td> </tr> </tbody> </table>	Code	Description	Qty	UOM	VN1177A0	CONTROL BOARD COOLING FAN	1	PZ								
Code	Description	Qty	UOM																		
VN1177A0	CONTROL BOARD COOLING FAN	1	PZ																		

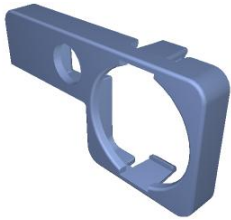
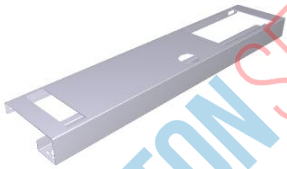

COMPONENT			SPARE PART										
Code	Description	Image	Code	Description	Components list								
VM2316A	CONTROL BOARD COOLING FAN HOLDER		KVM2518A	PANEL COOLING FAN SUPPORT KIT	<table border="1"> <thead> <tr> <th>Code</th> <th>Description</th> <th>Qty</th> <th>UOM</th> </tr> </thead> <tbody> <tr> <td>VM2518A0</td> <td>BOARD COOLING FAN SUPPORT</td> <td>1</td> <td>PZ</td> </tr> </tbody> </table>	Code	Description	Qty	UOM	VM2518A0	BOARD COOLING FAN SUPPORT	1	PZ
			Code	Description	Qty	UOM							
VM2518A0	BOARD COOLING FAN SUPPORT	1	PZ										
KVM2316A	PANEL COOLING FAN SUPPORT KIT	<table border="1"> <thead> <tr> <th>Code</th> <th>Description</th> <th>Qty</th> <th>UOM</th> </tr> </thead> <tbody> <tr> <td>VM2316A0</td> <td>CONTROL BOARD COOLING FAN HOLDER</td> <td>1</td> <td>PZ</td> </tr> </tbody> </table>	Code	Description	Qty	UOM	VM2316A0	CONTROL BOARD COOLING FAN HOLDER	1	PZ			
Code	Description	Qty	UOM										
VM2316A0	CONTROL BOARD COOLING FAN HOLDER	1	PZ										
0B1113A	0711 DOUBLE GLASS EXT SUP-INF PROFILE												
LP1020A	6 SERIES L400 LED LIGHT BAR - E583		KLP1020A	L400 E583 LED LIGHT BAR KIT	<table border="1"> <thead> <tr> <th>Code</th> <th>Description</th> <th>Qty</th> <th>UOM</th> </tr> </thead> <tbody> <tr> <td>IP1385A1</td> <td>CORNER POLYSTYREN E PACKING 110X80X2000</td> <td>1.240</td> <td>M</td> </tr> </tbody> </table>	Code	Description	Qty	UOM	IP1385A1	CORNER POLYSTYREN E PACKING 110X80X2000	1.240	M
			Code	Description	Qty	UOM							
			IP1385A1	CORNER POLYSTYREN E PACKING 110X80X2000	1.240	M							
					<table border="1"> <thead> <tr> <th>Code</th> <th>Description</th> <th>Qty</th> <th>UOM</th> </tr> </thead> <tbody> <tr> <td>LP1020A0</td> <td>6 SERIES L400 LED LIGHT BAR - E583</td> <td>1</td> <td>PZ</td> </tr> </tbody> </table>	Code	Description	Qty	UOM	LP1020A0	6 SERIES L400 LED LIGHT BAR - E583	1	PZ
Code	Description	Qty	UOM										
LP1020A0	6 SERIES L400 LED LIGHT BAR - E583	1	PZ										
		<table border="1"> <thead> <tr> <th>Code</th> <th>Description</th> <th>Qty</th> <th>UOM</th> </tr> </thead> <tbody> <tr> <td>VM1058A1</td> <td>HEAT SHRINK FILM H410</td> <td>1.240</td> <td>M</td> </tr> </tbody> </table>	Code	Description	Qty	UOM	VM1058A1	HEAT SHRINK FILM H410	1.240	M			
Code	Description	Qty	UOM										
VM1058A1	HEAT SHRINK FILM H410	1.240	M										
		<table border="1"> <thead> <tr> <th>Code</th> <th>Description</th> <th>Qty</th> <th>UOM</th> </tr> </thead> <tbody> <tr> <td>VM1059A1</td> <td>HEAT SHRINK FILM H800</td> <td>1.240</td> <td>M</td> </tr> </tbody> </table>	Code	Description	Qty	UOM	VM1059A1	HEAT SHRINK FILM H800	1.240	M			
Code	Description	Qty	UOM										
VM1059A1	HEAT SHRINK FILM H800	1.240	M										
LP1026A	L=583 S6 NO LED LIGHT BAR COVER		KLP1026A	L583 MM NO LED LIGHT HOLDER KIT	<table border="1"> <thead> <tr> <th>Code</th> <th>Description</th> <th>Qty</th> <th>UOM</th> </tr> </thead> <tbody> <tr> <td>IP1385A1</td> <td>CORNER POLYSTYREN E PACKING 110X80X2000</td> <td>1.240</td> <td>M</td> </tr> </tbody> </table>	Code	Description	Qty	UOM	IP1385A1	CORNER POLYSTYREN E PACKING 110X80X2000	1.240	M
			Code	Description	Qty	UOM							
			IP1385A1	CORNER POLYSTYREN E PACKING 110X80X2000	1.240	M							
					<table border="1"> <thead> <tr> <th>Code</th> <th>Description</th> <th>Qty</th> <th>UOM</th> </tr> </thead> <tbody> <tr> <td>LP1026A0</td> <td>L=583 S6 NO LED LIGHT BAR COVER</td> <td>1</td> <td>PZ</td> </tr> </tbody> </table>	Code	Description	Qty	UOM	LP1026A0	L=583 S6 NO LED LIGHT BAR COVER	1	PZ
Code	Description	Qty	UOM										
LP1026A0	L=583 S6 NO LED LIGHT BAR COVER	1	PZ										
		<table border="1"> <thead> <tr> <th>Code</th> <th>Description</th> <th>Qty</th> <th>UOM</th> </tr> </thead> <tbody> <tr> <td>VM1058A1</td> <td>HEAT SHRINK FILM H410</td> <td>1.240</td> <td>M</td> </tr> </tbody> </table>	Code	Description	Qty	UOM	VM1058A1	HEAT SHRINK FILM H410	1.240	M			
Code	Description	Qty	UOM										
VM1058A1	HEAT SHRINK FILM H410	1.240	M										
		<table border="1"> <thead> <tr> <th>Code</th> <th>Description</th> <th>Qty</th> <th>UOM</th> </tr> </thead> <tbody> <tr> <td>VM1059A1</td> <td>HEAT SHRINK FILM H800</td> <td>1.240</td> <td>M</td> </tr> </tbody> </table>	Code	Description	Qty	UOM	VM1059A1	HEAT SHRINK FILM H800	1.240	M			
Code	Description	Qty	UOM										
VM1059A1	HEAT SHRINK FILM H800	1.240	M										

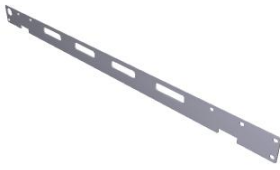

COMPONENT			SPARE PART																																																																																									
Code	Description	Image	Code	Description	Components list																																																																																							
OB1126A	DOOR LOWER FRAME SHAPE 860 MM		K0B1126AR	BAKERTOP MM RIGHT DOOR LOWER BEAM KIT	<table border="1"> <thead> <tr> <th>Code</th> <th>Description</th> <th>Qty</th> <th>UOM</th> </tr> </thead> <tbody> <tr> <td>OB1126A0</td> <td>DOOR LOWER FRAME SHAPE 860 MM</td> <td>1</td> <td>PZ</td> </tr> <tr> <td>RC1200A0</td> <td>ED=4 WIRE D.=0.5 COMPRESSIO N SPRING</td> <td>2</td> <td>PZ</td> </tr> <tr> <td>V11220A1</td> <td>4,2X12 TCB SELF-TAPPIN G SCREW</td> <td>1</td> <td>PZ</td> </tr> <tr> <td>V11996A0</td> <td>M5X35 SCREW</td> <td>7</td> <td>PZ</td> </tr> <tr> <td>VM1794A0</td> <td>250X4.8 PA66 BLACK CLAMP</td> <td>2</td> <td>PZ</td> </tr> <tr> <td>VM2103A0</td> <td>CLAMP LOCK</td> <td>2</td> <td>PZ</td> </tr> <tr> <td>VM2259A1</td> <td>6 SERIES DOOR LOWER LEFT CAP</td> <td>1</td> <td>PZ</td> </tr> <tr> <td>VM2261A1</td> <td>6 SERIES DOOR LOWER RIGHT CAP</td> <td>1</td> <td>PZ</td> </tr> <tr> <td>VM2267A0</td> <td>INTERNAL GLASS LOCKING SYSTEM SLIDER</td> <td>1</td> <td>PZ</td> </tr> <tr> <td>VM2269A0</td> <td>INTERNAL GLASS LOCKING SYSTEM CAP</td> <td>1</td> <td>PZ</td> </tr> <tr> <td>VM2274A0</td> <td>GROOVED BUSHING</td> <td>1</td> <td>PZ</td> </tr> <tr> <td>VM2305A0</td> <td>6 SERIES DOOR CAP FIXING PAWL</td> <td>7</td> <td>PZ</td> </tr> </tbody> </table>	Code	Description	Qty	UOM	OB1126A0	DOOR LOWER FRAME SHAPE 860 MM	1	PZ	RC1200A0	ED=4 WIRE D.=0.5 COMPRESSIO N SPRING	2	PZ	V11220A1	4,2X12 TCB SELF-TAPPIN G SCREW	1	PZ	V11996A0	M5X35 SCREW	7	PZ	VM1794A0	250X4.8 PA66 BLACK CLAMP	2	PZ	VM2103A0	CLAMP LOCK	2	PZ	VM2259A1	6 SERIES DOOR LOWER LEFT CAP	1	PZ	VM2261A1	6 SERIES DOOR LOWER RIGHT CAP	1	PZ	VM2267A0	INTERNAL GLASS LOCKING SYSTEM SLIDER	1	PZ	VM2269A0	INTERNAL GLASS LOCKING SYSTEM CAP	1	PZ	VM2274A0	GROOVED BUSHING	1	PZ	VM2305A0	6 SERIES DOOR CAP FIXING PAWL	7	PZ	K0B1126AL	BAKERTOP MM LEFT DOOR LOWER BEAM KIT	<table border="1"> <thead> <tr> <th>Code</th> <th>Description</th> <th>Qty</th> <th>UOM</th> </tr> </thead> <tbody> <tr> <td>OB1126A0</td> <td>DOOR LOWER FRAME SHAPE 860 MM</td> <td>1</td> <td>PZ</td> </tr> <tr> <td>RC1200A0</td> <td>ED=4 WIRE D.=0.5 COMPRESSIO N SPRING</td> <td>2</td> <td>PZ</td> </tr> <tr> <td>V11220A1</td> <td>4,2X12 TCB SELF-TAPPIN G SCREW</td> <td>1</td> <td>PZ</td> </tr> <tr> <td>V11996A0</td> <td>M5X35 SCREW</td> <td>7</td> <td>PZ</td> </tr> <tr> <td>VM1794A0</td> <td>250X4.8 PA66 BLACK CLAMP</td> <td>2</td> <td>PZ</td> </tr> <tr> <td>VM2103A0</td> <td>CLAMP LOCK</td> <td>2</td> <td>PZ</td> </tr> <tr> <td>VM2267A0</td> <td>INTERNAL GLASS LOCKING SYSTEM SLIDER</td> <td>1</td> <td>PZ</td> </tr> </tbody> </table>	Code	Description	Qty	UOM	OB1126A0	DOOR LOWER FRAME SHAPE 860 MM	1	PZ	RC1200A0	ED=4 WIRE D.=0.5 COMPRESSIO N SPRING	2	PZ	V11220A1	4,2X12 TCB SELF-TAPPIN G SCREW	1	PZ	V11996A0	M5X35 SCREW	7	PZ	VM1794A0	250X4.8 PA66 BLACK CLAMP	2	PZ	VM2103A0	CLAMP LOCK	2	PZ	VM2267A0	INTERNAL GLASS LOCKING SYSTEM SLIDER	1	PZ
			Code	Description	Qty	UOM																																																																																						
OB1126A0	DOOR LOWER FRAME SHAPE 860 MM	1	PZ																																																																																									
RC1200A0	ED=4 WIRE D.=0.5 COMPRESSIO N SPRING	2	PZ																																																																																									
V11220A1	4,2X12 TCB SELF-TAPPIN G SCREW	1	PZ																																																																																									
V11996A0	M5X35 SCREW	7	PZ																																																																																									
VM1794A0	250X4.8 PA66 BLACK CLAMP	2	PZ																																																																																									
VM2103A0	CLAMP LOCK	2	PZ																																																																																									
VM2259A1	6 SERIES DOOR LOWER LEFT CAP	1	PZ																																																																																									
VM2261A1	6 SERIES DOOR LOWER RIGHT CAP	1	PZ																																																																																									
VM2267A0	INTERNAL GLASS LOCKING SYSTEM SLIDER	1	PZ																																																																																									
VM2269A0	INTERNAL GLASS LOCKING SYSTEM CAP	1	PZ																																																																																									
VM2274A0	GROOVED BUSHING	1	PZ																																																																																									
VM2305A0	6 SERIES DOOR CAP FIXING PAWL	7	PZ																																																																																									
Code	Description	Qty	UOM																																																																																									
OB1126A0	DOOR LOWER FRAME SHAPE 860 MM	1	PZ																																																																																									
RC1200A0	ED=4 WIRE D.=0.5 COMPRESSIO N SPRING	2	PZ																																																																																									
V11220A1	4,2X12 TCB SELF-TAPPIN G SCREW	1	PZ																																																																																									
V11996A0	M5X35 SCREW	7	PZ																																																																																									
VM1794A0	250X4.8 PA66 BLACK CLAMP	2	PZ																																																																																									
VM2103A0	CLAMP LOCK	2	PZ																																																																																									
VM2267A0	INTERNAL GLASS LOCKING SYSTEM SLIDER	1	PZ																																																																																									

COMPONENT			SPARE PART																										
Code	Description	Image	Code	Description	Components list																								
OB1126A	DOOR LOWER FRAME SHAPE 860 MM		K0B1126AL	BAKERTOP MM LEFT DOOR LOWER BEAM KIT	<table border="1"> <thead> <tr> <th>Code</th> <th>Description</th> <th>Qty</th> <th>UOM</th> </tr> </thead> <tbody> <tr> <td>VM2269A0</td> <td>INTERNAL GLASS LOCKING SYSTEM CAP</td> <td>1</td> <td>PZ</td> </tr> <tr> <td>VM2274A0</td> <td>GROOVED BUSHING</td> <td>1</td> <td>PZ</td> </tr> <tr> <td>VM2305A0</td> <td>6 SERIES DOOR CAP FIXING PAWL</td> <td>7</td> <td>PZ</td> </tr> <tr> <td>VM2384A0</td> <td>LEFT MM DOOR LOWER RIGHT CAP</td> <td>1</td> <td>PZ</td> </tr> <tr> <td>VM2386A1</td> <td>LEFT MM DOOR LOWER LEFT CAP</td> <td>1</td> <td>PZ</td> </tr> </tbody> </table>	Code	Description	Qty	UOM	VM2269A0	INTERNAL GLASS LOCKING SYSTEM CAP	1	PZ	VM2274A0	GROOVED BUSHING	1	PZ	VM2305A0	6 SERIES DOOR CAP FIXING PAWL	7	PZ	VM2384A0	LEFT MM DOOR LOWER RIGHT CAP	1	PZ	VM2386A1	LEFT MM DOOR LOWER LEFT CAP	1	PZ
Code	Description	Qty	UOM																										
VM2269A0	INTERNAL GLASS LOCKING SYSTEM CAP	1	PZ																										
VM2274A0	GROOVED BUSHING	1	PZ																										
VM2305A0	6 SERIES DOOR CAP FIXING PAWL	7	PZ																										
VM2384A0	LEFT MM DOOR LOWER RIGHT CAP	1	PZ																										
VM2386A1	LEFT MM DOOR LOWER LEFT CAP	1	PZ																										
VM2312A	6 S. DRIP PROFILE DRAIN LEFT PIPE		KVM2312A	M.M. DRIP TRAY LEFT DRAIN PIPE KI	<table border="1"> <thead> <tr> <th>Code</th> <th>Description</th> <th>Qty</th> <th>UOM</th> </tr> </thead> <tbody> <tr> <td>VM2312A0</td> <td>6 S. DRIP PROFILE DRAIN LEFT PIPE</td> <td>1</td> <td>PZ</td> </tr> </tbody> </table>	Code	Description	Qty	UOM	VM2312A0	6 S. DRIP PROFILE DRAIN LEFT PIPE	1	PZ																
Code	Description	Qty	UOM																										
VM2312A0	6 S. DRIP PROFILE DRAIN LEFT PIPE	1	PZ																										
VM2314A	6 S. DRIP PROFILE CAP		KVM2314A	MIND.MAPS DRIP TRAY CAP	<table border="1"> <thead> <tr> <th>Code</th> <th>Description</th> <th>Qty</th> <th>UOM</th> </tr> </thead> <tbody> <tr> <td>VM2314A0</td> <td>6 S. DRIP PROFILE CAP</td> <td>1</td> <td>PZ</td> </tr> </tbody> </table>	Code	Description	Qty	UOM	VM2314A0	6 S. DRIP PROFILE CAP	1	PZ																
Code	Description	Qty	UOM																										
VM2314A0	6 S. DRIP PROFILE CAP	1	PZ																										
VM2285A	860 SERIES DRIP PROFILE		KVM2285A	860 SERIES DRIP PROFILE KIT	<table border="1"> <thead> <tr> <th>Code</th> <th>Description</th> <th>Qty</th> <th>UOM</th> </tr> </thead> <tbody> <tr> <td>VM2285A0</td> <td>860 SERIES DRIP PROFILE</td> <td>1</td> <td>PZ</td> </tr> </tbody> </table>	Code	Description	Qty	UOM	VM2285A0	860 SERIES DRIP PROFILE	1	PZ																
Code	Description	Qty	UOM																										
VM2285A0	860 SERIES DRIP PROFILE	1	PZ																										



COMPONENT			SPARE PART																																		
Code	Description	Image	Code	Description	Components list																																
VM2313A	TUBE DX DISCHARGE DRIP M		KVM2313A	MM DRIP PROFILE DRAIN RIGHT PIPE KIT	<table border="1"> <thead> <tr> <th>Code</th> <th>Description</th> <th>Qty</th> <th>UOM</th> </tr> </thead> <tbody> <tr> <td>VM2313A0</td> <td>TUBE DX DISCHARGE DRIP MM</td> <td>1</td> <td>PZ</td> </tr> </tbody> </table>	Code	Description	Qty	UOM	VM2313A0	TUBE DX DISCHARGE DRIP MM	1	PZ																								
Code	Description	Qty	UOM																																		
VM2313A0	TUBE DX DISCHARGE DRIP MM	1	PZ																																		
VT1291A	XEBC-06EU-E EXTERNAL GLASS		KVT1291A	06EU EXTERNAL GLASS KIT	<table border="1"> <thead> <tr> <th>Code</th> <th>Description</th> <th>Qty</th> <th>UOM</th> </tr> </thead> <tbody> <tr> <td>0B1167A0</td> <td>EXT. GLASS SUPPORT PROFILE</td> <td>2</td> <td>PZ</td> </tr> <tr> <td>IP1508A0</td> <td></td> <td>1</td> <td>PZ</td> </tr> <tr> <td>IP1508A1</td> <td>POLYSTYREN E U SHAPED PROFILE 2000X60X60</td> <td>1</td> <td>M</td> </tr> <tr> <td>SL1155A1</td> <td>SILICON BICOMPONEN T LOCTITE</td> <td>150</td> <td>ML</td> </tr> <tr> <td>SL1156A0</td> <td>NOZZLE FOR SILICON GUN</td> <td>1</td> <td>PZ</td> </tr> <tr> <td>VM1059A1</td> <td>HEAT SHRINK FILM H800</td> <td>1.500</td> <td>M</td> </tr> <tr> <td>VT1291A0</td> <td>XEBC-06EU-E EXTERNAL GLASS</td> <td>1</td> <td>PZ</td> </tr> </tbody> </table>	Code	Description	Qty	UOM	0B1167A0	EXT. GLASS SUPPORT PROFILE	2	PZ	IP1508A0		1	PZ	IP1508A1	POLYSTYREN E U SHAPED PROFILE 2000X60X60	1	M	SL1155A1	SILICON BICOMPONEN T LOCTITE	150	ML	SL1156A0	NOZZLE FOR SILICON GUN	1	PZ	VM1059A1	HEAT SHRINK FILM H800	1.500	M	VT1291A0	XEBC-06EU-E EXTERNAL GLASS	1	PZ
Code	Description	Qty	UOM																																		
0B1167A0	EXT. GLASS SUPPORT PROFILE	2	PZ																																		
IP1508A0		1	PZ																																		
IP1508A1	POLYSTYREN E U SHAPED PROFILE 2000X60X60	1	M																																		
SL1155A1	SILICON BICOMPONEN T LOCTITE	150	ML																																		
SL1156A0	NOZZLE FOR SILICON GUN	1	PZ																																		
VM1059A1	HEAT SHRINK FILM H800	1.500	M																																		
VT1291A0	XEBC-06EU-E EXTERNAL GLASS	1	PZ																																		
VI1034A	STAINLESS STEEL WASHER 8.4X16X1		VI1034A0	STAINLESS STEEL WASHER 8.4X16X1																																	
0B1218A	MM DOUBLE GLASS DOOR UPPER BEAM 860		0B1218A0	MM DOUBLE GLASS DOOR UPPER BEAM 860																																	

COMPONENT			SPARE PART														
Code	Description	Image	Code	Description	Components list												
VM2410A	PLATE TO STOP EXTRUDED LED BAR		KVM2410A	PLATE TO STOP EXTRUDED LED BAR 2P KIT	<table border="1"> <thead> <tr> <th>Code</th> <th>Description</th> <th>Qty</th> <th>UOM</th> </tr> </thead> <tbody> <tr> <td>0B1190A0</td> <td>PLATE TO STOP EXTRUDED LED BAR</td> <td>2</td> <td>PZ</td> </tr> <tr> <td>VM2410A0</td> <td>PLATE TO STOP EXTRUDED LED BAR</td> <td>2</td> <td>PZ</td> </tr> </tbody> </table>	Code	Description	Qty	UOM	0B1190A0	PLATE TO STOP EXTRUDED LED BAR	2	PZ	VM2410A0	PLATE TO STOP EXTRUDED LED BAR	2	PZ
Code	Description	Qty	UOM														
0B1190A0	PLATE TO STOP EXTRUDED LED BAR	2	PZ														
VM2410A0	PLATE TO STOP EXTRUDED LED BAR	2	PZ														
VM2305A	6 SERIES DOOR CAP FIXING PAWL		KVM2305A	MM FIXING DOOR THUB SCREWS 10 PCS KIT	<table border="1"> <thead> <tr> <th>Code</th> <th>Description</th> <th>Qty</th> <th>UOM</th> </tr> </thead> <tbody> <tr> <td>VM2305A0</td> <td>6 SERIES DOOR CAP FIXING PAWL</td> <td>10</td> <td>PZ</td> </tr> </tbody> </table>	Code	Description	Qty	UOM	VM2305A0	6 SERIES DOOR CAP FIXING PAWL	10	PZ				
Code	Description	Qty	UOM														
VM2305A0	6 SERIES DOOR CAP FIXING PAWL	10	PZ														
VM2275A	SMOOTH BUSHING		KVM2275A	SMOOTH PIN BUSHING KIT	<table border="1"> <thead> <tr> <th>Code</th> <th>Description</th> <th>Qty</th> <th>UOM</th> </tr> </thead> <tbody> <tr> <td>VM2275A0</td> <td>SMOOTH BUSHING</td> <td>1</td> <td>PZ</td> </tr> </tbody> </table>	Code	Description	Qty	UOM	VM2275A0	SMOOTH BUSHING	1	PZ				
Code	Description	Qty	UOM														
VM2275A0	SMOOTH BUSHING	1	PZ														
VI1996A	M5X35 SCREW		VI1996A0	M5X35 SCREW													
VM2260A	6 SERIES DOOR UPPER LEFT CAP		KVM2260A	MIND.MAPS DOOR LEFT UPPER CAP KI	<table border="1"> <thead> <tr> <th>Code</th> <th>Description</th> <th>Qty</th> <th>UOM</th> </tr> </thead> <tbody> <tr> <td>VM2260A1</td> <td>6 SERIES DOOR UPPER LEFT CAP</td> <td>1</td> <td>PZ</td> </tr> </tbody> </table>	Code	Description	Qty	UOM	VM2260A1	6 SERIES DOOR UPPER LEFT CAP	1	PZ				
Code	Description	Qty	UOM														
VM2260A1	6 SERIES DOOR UPPER LEFT CAP	1	PZ														

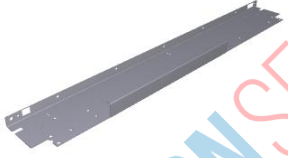
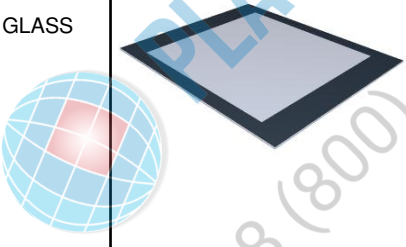
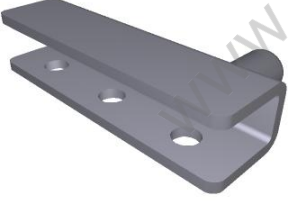
COMPONENT			SPARE PART																														
Code	Description	Image	Code	Description	Components list																												
OB1175A	XEBC-06EU-E LEFT EXT DOOR COLUMN		OB1175A0	XEBC-06EU-E LEFT EXT DOOR COLUMN																													
OB1114A																																	
VT1294A	XEBC-06EU-E INTERNAL GLASS		KVT1294A	06EU INTERNAL SINGLE GLASS KIT	<table border="1"> <thead> <tr> <th>Code</th> <th>Description</th> <th>Qty</th> <th>UOM</th> </tr> </thead> <tbody> <tr> <td>IP1508A0</td> <td></td> <td>1</td> <td>PZ</td> </tr> <tr> <td>IP1508A1</td> <td>POLYSTYREN E U SHAPED PROFILE 2000X60X60</td> <td>1</td> <td>M</td> </tr> <tr> <td>VM1059A1</td> <td>HEAT SHRINK FILM H800</td> <td>1.500</td> <td>M</td> </tr> <tr> <td>VT1294A0</td> <td>XEBC-06EU-E INTERNAL GLASS</td> <td>1</td> <td>PZ</td> </tr> </tbody> </table>	Code	Description	Qty	UOM	IP1508A0		1	PZ	IP1508A1	POLYSTYREN E U SHAPED PROFILE 2000X60X60	1	M	VM1059A1	HEAT SHRINK FILM H800	1.500	M	VT1294A0	XEBC-06EU-E INTERNAL GLASS	1	PZ								
Code	Description	Qty	UOM																														
IP1508A0		1	PZ																														
IP1508A1	POLYSTYREN E U SHAPED PROFILE 2000X60X60	1	M																														
VM1059A1	HEAT SHRINK FILM H800	1.500	M																														
VT1294A0	XEBC-06EU-E INTERNAL GLASS	1	PZ																														
CR1103A	INTERNAL GLASS ST. STEEL UPPER HINGE		KCR1103A	INTERNAL GLASS UPPER HINGE KIT	<table border="1"> <thead> <tr> <th>Code</th> <th>Description</th> <th>Qty</th> <th>UOM</th> </tr> </thead> <tbody> <tr> <td>CR1103A0</td> <td>INTERNAL GLASS ST. STEEL UPPER HINGE</td> <td>1</td> <td>PZ</td> </tr> <tr> <td>GN1182A0</td> <td>INTERNAL GLASS HINGE CR1103-1104 SEAL</td> <td>1</td> <td>PZ</td> </tr> <tr> <td>GN1182A1</td> <td>INTERNAL GLASS HINGE CR1103-1104 SEAL</td> <td>1</td> <td>PZ</td> </tr> <tr> <td>SL1045A0</td> <td>S53 BLACK SILICONE - 80ML CARTRIDGE</td> <td>1</td> <td>PZ</td> </tr> <tr> <td>VI1810A0</td> <td>M6X6 STAINLESS STEEL FLATHEAD SCREW</td> <td>3</td> <td>PZ</td> </tr> <tr> <td>VM2476A0</td> <td>BL SP H6 INTERNAL GLASS HINGE SCREW</td> <td>1</td> <td>PZ</td> </tr> </tbody> </table>	Code	Description	Qty	UOM	CR1103A0	INTERNAL GLASS ST. STEEL UPPER HINGE	1	PZ	GN1182A0	INTERNAL GLASS HINGE CR1103-1104 SEAL	1	PZ	GN1182A1	INTERNAL GLASS HINGE CR1103-1104 SEAL	1	PZ	SL1045A0	S53 BLACK SILICONE - 80ML CARTRIDGE	1	PZ	VI1810A0	M6X6 STAINLESS STEEL FLATHEAD SCREW	3	PZ	VM2476A0	BL SP H6 INTERNAL GLASS HINGE SCREW	1	PZ
Code	Description	Qty	UOM																														
CR1103A0	INTERNAL GLASS ST. STEEL UPPER HINGE	1	PZ																														
GN1182A0	INTERNAL GLASS HINGE CR1103-1104 SEAL	1	PZ																														
GN1182A1	INTERNAL GLASS HINGE CR1103-1104 SEAL	1	PZ																														
SL1045A0	S53 BLACK SILICONE - 80ML CARTRIDGE	1	PZ																														
VI1810A0	M6X6 STAINLESS STEEL FLATHEAD SCREW	3	PZ																														
VM2476A0	BL SP H6 INTERNAL GLASS HINGE SCREW	1	PZ																														

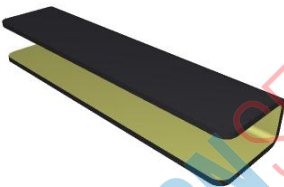
COMPONENT			SPARE PART																														
Code	Description	Image	Code	Description	Components list																												
VM2399A	DOOR HINGES NO HEAD SCREW COVE		VM2399A0	DOOR HINGES NO HEAD SCREW COVE																													
GN1182A	INTERNAL GLASS HINGE CR1103-1104 SEAL		KVM2476A	INTERNAL GLASS HINGE SEAL 2PCS KIT	<table border="1"> <thead> <tr> <th>Code</th> <th>Description</th> <th>Qty</th> <th>UOM</th> </tr> </thead> <tbody> <tr> <td>SL1045A0</td> <td>S53 BLACK SILICONE - 80ML CARTRIDGE</td> <td>1</td> <td>PZ</td> </tr> <tr> <td>VM2476A0</td> <td>BL SP H6 INTERNAL GLASS HINGE SCREW</td> <td>2</td> <td>PZ</td> </tr> </tbody> </table>	Code	Description	Qty	UOM	SL1045A0	S53 BLACK SILICONE - 80ML CARTRIDGE	1	PZ	VM2476A0	BL SP H6 INTERNAL GLASS HINGE SCREW	2	PZ																
Code	Description	Qty	UOM																														
SL1045A0	S53 BLACK SILICONE - 80ML CARTRIDGE	1	PZ																														
VM2476A0	BL SP H6 INTERNAL GLASS HINGE SCREW	2	PZ																														
CR1104A	INTERNAL GLASS ST. STEEL LOWER HINGE		KCR1104A	INTERNAL GLASS LOWER HINGE KIT	<table border="1"> <thead> <tr> <th>Code</th> <th>Description</th> <th>Qty</th> <th>UOM</th> </tr> </thead> <tbody> <tr> <td>CR1104A0</td> <td>INTERNAL GLASS ST. STEEL LOWER HINGE</td> <td>1</td> <td>PZ</td> </tr> <tr> <td>GN1182A0</td> <td>INTERNAL GLASS HINGE CR1103-1104 SEAL</td> <td>1</td> <td>PZ</td> </tr> <tr> <td>GN1182A1</td> <td>INTERNAL GLASS HINGE CR1103-1104 SEAL</td> <td>1</td> <td>PZ</td> </tr> <tr> <td>SL1045A0</td> <td>S53 BLACK SILICONE - 80ML CARTRIDGE</td> <td>1</td> <td>PZ</td> </tr> <tr> <td>VI1810A0</td> <td>M6X6 STAINLESS STEEL FLATHEAD SCREW</td> <td>3</td> <td>PZ</td> </tr> <tr> <td>VM2476A0</td> <td>BL SP H6 INTERNAL GLASS HINGE SCREW</td> <td>1</td> <td>PZ</td> </tr> </tbody> </table>	Code	Description	Qty	UOM	CR1104A0	INTERNAL GLASS ST. STEEL LOWER HINGE	1	PZ	GN1182A0	INTERNAL GLASS HINGE CR1103-1104 SEAL	1	PZ	GN1182A1	INTERNAL GLASS HINGE CR1103-1104 SEAL	1	PZ	SL1045A0	S53 BLACK SILICONE - 80ML CARTRIDGE	1	PZ	VI1810A0	M6X6 STAINLESS STEEL FLATHEAD SCREW	3	PZ	VM2476A0	BL SP H6 INTERNAL GLASS HINGE SCREW	1	PZ
Code	Description	Qty	UOM																														
CR1104A0	INTERNAL GLASS ST. STEEL LOWER HINGE	1	PZ																														
GN1182A0	INTERNAL GLASS HINGE CR1103-1104 SEAL	1	PZ																														
GN1182A1	INTERNAL GLASS HINGE CR1103-1104 SEAL	1	PZ																														
SL1045A0	S53 BLACK SILICONE - 80ML CARTRIDGE	1	PZ																														
VI1810A0	M6X6 STAINLESS STEEL FLATHEAD SCREW	3	PZ																														
VM2476A0	BL SP H6 INTERNAL GLASS HINGE SCREW	1	PZ																														



COMPONENT			SPARE PART																										
Code	Description	Image	Code	Description	Components list																								
VM2399A	DOOR HINGES NO HEAD SCREW COVE		VM2399A0	DOOR HINGES NO HEAD SCREW COVE																									
GN1182A	INTERNAL GLASS HINGE CR1103-1104 SEAL		KVM2476A	INTERNAL GLASS HINGE SEAL 2PCS KIT	<table border="1"> <thead> <tr> <th>Code</th> <th>Description</th> <th>Qty</th> <th>UOM</th> </tr> </thead> <tbody> <tr> <td>SL1045A0</td> <td>S53 BLACK SILICONE - 80ML CARTRIDGE</td> <td>1</td> <td>PZ</td> </tr> <tr> <td>VM2476A0</td> <td>BL SP H6 INTERNAL GLASS HINGE SCREW</td> <td>2</td> <td>PZ</td> </tr> </tbody> </table>	Code	Description	Qty	UOM	SL1045A0	S53 BLACK SILICONE - 80ML CARTRIDGE	1	PZ	VM2476A0	BL SP H6 INTERNAL GLASS HINGE SCREW	2	PZ												
Code	Description	Qty	UOM																										
SL1045A0	S53 BLACK SILICONE - 80ML CARTRIDGE	1	PZ																										
VM2476A0	BL SP H6 INTERNAL GLASS HINGE SCREW	2	PZ																										
0B1112A	0711 RIGHT - DOOR LEFT INT COLUMN																												
0B1219A	MM DOUBLE GLASS DOOR INT UPPER BEAM 860		0B1219A1	MM DOUBLE GLASS DOOR INT UPPER BEAM 860																									
PE2046A	MM POWER SWITCH AND USB BOARD		KPE2046A	MIND.MAPS USB-RESET SUPPORT KIT	<table border="1"> <thead> <tr> <th>Code</th> <th>Description</th> <th>Qty</th> <th>UOM</th> </tr> </thead> <tbody> <tr> <td>PE2046A0</td> <td>MM POWER SWITCH AND USB BOARD</td> <td>1</td> <td>PZ</td> </tr> <tr> <td>PE2046A1</td> <td>MM POWER SWITCH AND USB BOARD</td> <td>1</td> <td>PZ</td> </tr> <tr> <td>PE2046A2</td> <td>MM POWER SWITCH AND USB BOARD</td> <td>1</td> <td>PZ</td> </tr> <tr> <td>VI1220A1</td> <td>4,2X12 TCB SELF-TAPPING G SCREW</td> <td>2</td> <td>PZ</td> </tr> <tr> <td>VM2147A0</td> <td>ESD SPONGE PINK SMOOTH 410X343X15 M</td> <td>0.250</td> <td>PZ</td> </tr> </tbody> </table>	Code	Description	Qty	UOM	PE2046A0	MM POWER SWITCH AND USB BOARD	1	PZ	PE2046A1	MM POWER SWITCH AND USB BOARD	1	PZ	PE2046A2	MM POWER SWITCH AND USB BOARD	1	PZ	VI1220A1	4,2X12 TCB SELF-TAPPING G SCREW	2	PZ	VM2147A0	ESD SPONGE PINK SMOOTH 410X343X15 M	0.250	PZ
Code	Description	Qty	UOM																										
PE2046A0	MM POWER SWITCH AND USB BOARD	1	PZ																										
PE2046A1	MM POWER SWITCH AND USB BOARD	1	PZ																										
PE2046A2	MM POWER SWITCH AND USB BOARD	1	PZ																										
VI1220A1	4,2X12 TCB SELF-TAPPING G SCREW	2	PZ																										
VM2147A0	ESD SPONGE PINK SMOOTH 410X343X15 M	0.250	PZ																										



COMPONENT			SPARE PART																																		
Code	Description	Image	Code	Description	Components list																																
PE2042A	MM ONE VERSION CONTROL BOARD		KPE2042A	MIND.MAPS ONE CONTROL BOARD KIT	<table border="1"> <thead> <tr> <th>Code</th> <th>Description</th> <th>Qty</th> <th>UOM</th> </tr> </thead> <tbody> <tr> <td>PE2042A0</td> <td>MM ONE VERSION CONTROL BOARD</td> <td>1</td> <td>PZ</td> </tr> <tr> <td>PE2042A1</td> <td>MM ONE VERSION CONTROL BOARD</td> <td>1</td> <td>PZ</td> </tr> <tr> <td>PE2042A2</td> <td>MM ONE VERSION CONTROL BOARD</td> <td>1</td> <td>PZ</td> </tr> <tr> <td>PE2042A3</td> <td>MM ONE VERSION CONTROL BOARD</td> <td>1</td> <td>PZ</td> </tr> <tr> <td>PE2042A4</td> <td>MM ONE VERSION CONTROL BOARD</td> <td>1</td> <td>PZ</td> </tr> <tr> <td>VI2000A0</td> <td>SCREW M4X22 TCB+ INOX</td> <td>4</td> <td>PZ</td> </tr> <tr> <td>VM2147A0</td> <td>ESD SPONGE PINK SMOOTH 410X343X15 M</td> <td>1</td> <td>PZ</td> </tr> </tbody> </table>	Code	Description	Qty	UOM	PE2042A0	MM ONE VERSION CONTROL BOARD	1	PZ	PE2042A1	MM ONE VERSION CONTROL BOARD	1	PZ	PE2042A2	MM ONE VERSION CONTROL BOARD	1	PZ	PE2042A3	MM ONE VERSION CONTROL BOARD	1	PZ	PE2042A4	MM ONE VERSION CONTROL BOARD	1	PZ	VI2000A0	SCREW M4X22 TCB+ INOX	4	PZ	VM2147A0	ESD SPONGE PINK SMOOTH 410X343X15 M	1	PZ
Code	Description	Qty	UOM																																		
PE2042A0	MM ONE VERSION CONTROL BOARD	1	PZ																																		
PE2042A1	MM ONE VERSION CONTROL BOARD	1	PZ																																		
PE2042A2	MM ONE VERSION CONTROL BOARD	1	PZ																																		
PE2042A3	MM ONE VERSION CONTROL BOARD	1	PZ																																		
PE2042A4	MM ONE VERSION CONTROL BOARD	1	PZ																																		
VI2000A0	SCREW M4X22 TCB+ INOX	4	PZ																																		
VM2147A0	ESD SPONGE PINK SMOOTH 410X343X15 M	1	PZ																																		



PLATON SERVICE  
 8 (800) 500-34-47  
 www.platonservice.com

**ASM1745A/0.D03 - Cooking chamber**

**FRONT**



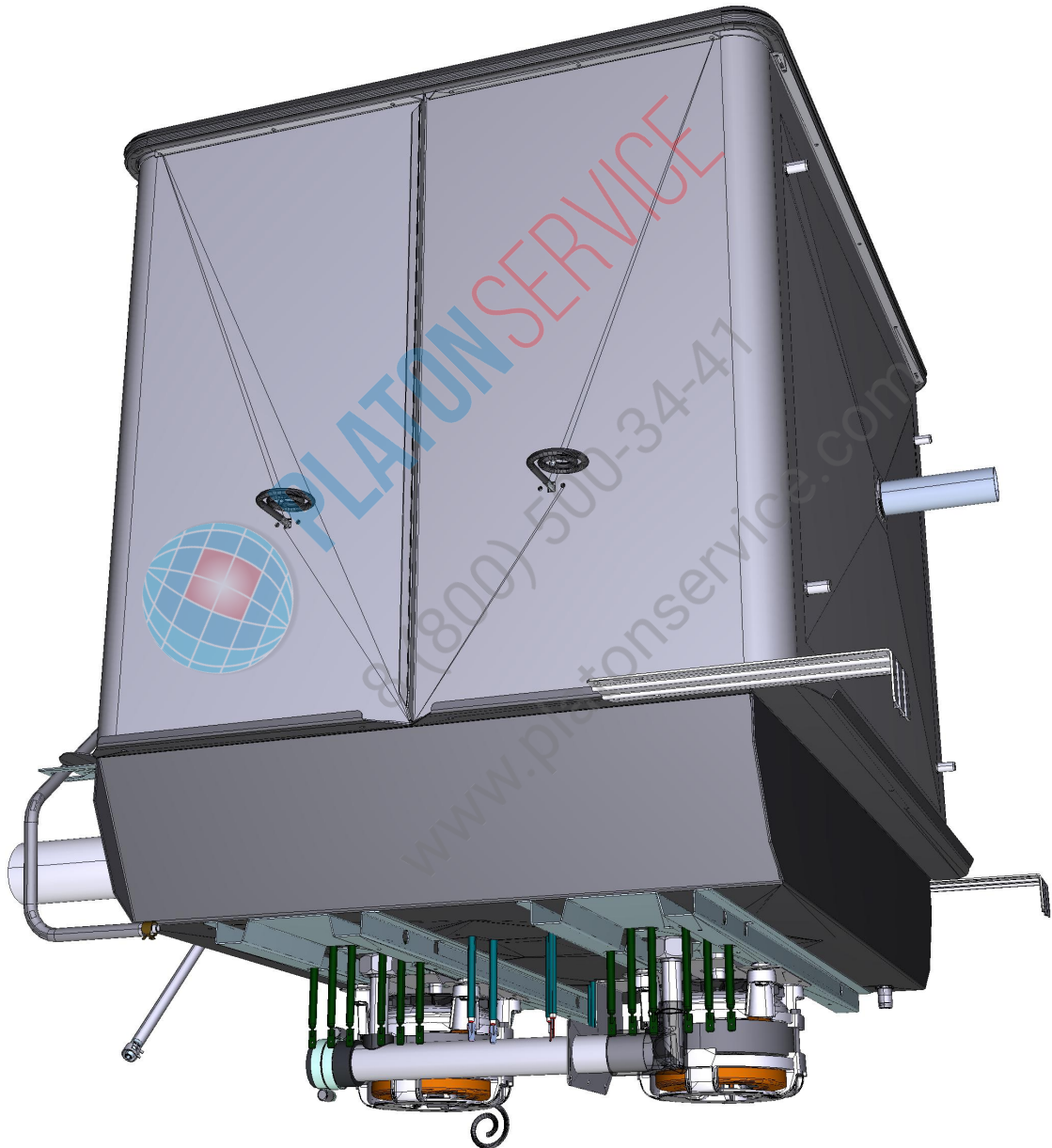

ASM1745A/0.D03 - Cooking chamber

REAR









COMPONENT			SPARE PART																										
Code	Description	Image	Code	Description	Components list																								
GN1326A	ELEMENT SEALING		KRS1274A	100W MOTOR BRAKING ELEMENT KIT	<table border="1"> <thead> <tr> <th>Code</th> <th>Description</th> <th>Qty</th> <th>UOM</th> </tr> </thead> <tbody> <tr> <td>GN1326A1</td> <td>ELEMENT SEALING</td> <td>1</td> <td>PZ</td> </tr> <tr> <td>RS1274A0</td> <td>100W 60V 1 TURN FLAT ELEMENT</td> <td>1</td> <td>PZ</td> </tr> <tr> <td>SL1045A0</td> <td>S53 BLACK SILICONE - 80ML CARTRIDGE</td> <td>1</td> <td>PZ</td> </tr> <tr> <td>VI1220A1</td> <td>4,2X12 TCB SELF-TAPPIN G SCREW</td> <td>2</td> <td>PZ</td> </tr> </tbody> </table>	Code	Description	Qty	UOM	GN1326A1	ELEMENT SEALING	1	PZ	RS1274A0	100W 60V 1 TURN FLAT ELEMENT	1	PZ	SL1045A0	S53 BLACK SILICONE - 80ML CARTRIDGE	1	PZ	VI1220A1	4,2X12 TCB SELF-TAPPIN G SCREW	2	PZ				
					Code	Description	Qty	UOM																					
					GN1326A1	ELEMENT SEALING	1	PZ																					
					RS1274A0	100W 60V 1 TURN FLAT ELEMENT	1	PZ																					
			SL1045A0	S53 BLACK SILICONE - 80ML CARTRIDGE	1	PZ																							
			VI1220A1	4,2X12 TCB SELF-TAPPIN G SCREW	2	PZ																							
			KRS1261A	122W MOTOR BREAKING ELEMENT KIT	<table border="1"> <thead> <tr> <th>Code</th> <th>Description</th> <th>Qty</th> <th>UOM</th> </tr> </thead> <tbody> <tr> <td>GN1326A1</td> <td>ELEMENT SEALING</td> <td>1</td> <td>PZ</td> </tr> <tr> <td>RS1261A0</td> <td>BAKERLUX/CH EFLUX MOTOR BREAKING ELEMENT</td> <td>1</td> <td>PZ</td> </tr> <tr> <td>SL1045A0</td> <td>S53 BLACK SILICONE - 80ML CARTRIDGE</td> <td>1</td> <td>PZ</td> </tr> <tr> <td>VI1220A1</td> <td>4,2X12 TCB SELF-TAPPIN G SCREW</td> <td>2</td> <td>PZ</td> </tr> <tr> <td>VM2147A0</td> <td>ESD SPONGE PINK SMOOTH 410X343X15 M</td> <td>1</td> <td>PZ</td> </tr> </tbody> </table>	Code	Description	Qty	UOM	GN1326A1	ELEMENT SEALING	1	PZ	RS1261A0	BAKERLUX/CH EFLUX MOTOR BREAKING ELEMENT	1	PZ	SL1045A0	S53 BLACK SILICONE - 80ML CARTRIDGE	1	PZ	VI1220A1	4,2X12 TCB SELF-TAPPIN G SCREW	2	PZ	VM2147A0	ESD SPONGE PINK SMOOTH 410X343X15 M	1	PZ
					Code	Description	Qty	UOM																					
					GN1326A1	ELEMENT SEALING	1	PZ																					
					RS1261A0	BAKERLUX/CH EFLUX MOTOR BREAKING ELEMENT	1	PZ																					
			SL1045A0	S53 BLACK SILICONE - 80ML CARTRIDGE	1	PZ																							
			VI1220A1	4,2X12 TCB SELF-TAPPIN G SCREW	2	PZ																							
VM2147A0	ESD SPONGE PINK SMOOTH 410X343X15 M	1	PZ																										
KRS1215A	147W MOTOR BRAKING ELEMENT KIT	<table border="1"> <thead> <tr> <th>Code</th> <th>Description</th> <th>Qty</th> <th>UOM</th> </tr> </thead> <tbody> <tr> <td>GN1326A1</td> <td>ELEMENT SEALING</td> <td>1</td> <td>PZ</td> </tr> <tr> <td>RS1215A1</td> <td>147W 105V BRAKING ELEMENT</td> <td>1</td> <td>PZ</td> </tr> <tr> <td>SL1045A0</td> <td>S53 BLACK SILICONE - 80ML CARTRIDGE</td> <td>1</td> <td>PZ</td> </tr> <tr> <td>VI1220A1</td> <td>4,2X12 TCB SELF-TAPPIN G SCREW</td> <td>2</td> <td>PZ</td> </tr> <tr> <td>VM2147A0</td> <td>ESD SPONGE PINK SMOOTH 410X343X15 M</td> <td>1</td> <td>PZ</td> </tr> </tbody> </table>	Code	Description	Qty	UOM	GN1326A1	ELEMENT SEALING	1	PZ	RS1215A1	147W 105V BRAKING ELEMENT	1	PZ	SL1045A0	S53 BLACK SILICONE - 80ML CARTRIDGE	1	PZ	VI1220A1	4,2X12 TCB SELF-TAPPIN G SCREW	2	PZ	VM2147A0	ESD SPONGE PINK SMOOTH 410X343X15 M	1	PZ			
		Code	Description	Qty	UOM																								
		GN1326A1	ELEMENT SEALING	1	PZ																								
		RS1215A1	147W 105V BRAKING ELEMENT	1	PZ																								
SL1045A0	S53 BLACK SILICONE - 80ML CARTRIDGE	1	PZ																										
VI1220A1	4,2X12 TCB SELF-TAPPIN G SCREW	2	PZ																										
VM2147A0	ESD SPONGE PINK SMOOTH 410X343X15 M	1	PZ																										
KRS1095A	1.2KW HEATING ELEMENT KIT	<table border="1"> <thead> <tr> <th>Code</th> <th>Description</th> <th>Qty</th> <th>UOM</th> </tr> </thead> <tbody> <tr> <td>GN1326A1</td> <td>ELEMENT SEALING</td> <td>1</td> <td>PZ</td> </tr> <tr> <td>IP1385A0</td> <td></td> <td>1.200</td> <td>PZ</td> </tr> </tbody> </table>	Code	Description	Qty	UOM	GN1326A1	ELEMENT SEALING	1	PZ	IP1385A0		1.200	PZ															
		Code	Description	Qty	UOM																								
GN1326A1	ELEMENT SEALING	1	PZ																										
IP1385A0		1.200	PZ																										

COMPONENT			SPARE PART																											
Code	Description	Image	Code	Description	Components list																									
GN1326A	ELEMENT SEALING		KRS1095A	1.2KW HEATING ELEMENT KIT	<table border="1"> <thead> <tr> <th>Code</th> <th>Description</th> <th>Qty</th> <th>UOM</th> </tr> </thead> <tbody> <tr> <td>IP1385A1</td> <td>CORNER POLYSTYRENE PACKING 110X80X2000</td> <td>0.500</td> <td>M</td> </tr> <tr> <td>RS1095A1</td> <td>HEATING ELEMENT 1200W 230V</td> <td>1</td> <td>PZ</td> </tr> <tr> <td>SL1045A0</td> <td>S53 BLACK SILICONE - 80ML CARTRIDGE</td> <td>1</td> <td>PZ</td> </tr> <tr> <td>VI1220A1</td> <td>4,2X12 TCB SELF-TAPPIN G SCREW</td> <td>2</td> <td>PZ</td> </tr> <tr> <td>VM1059A1</td> <td>HEAT SHRINK FILM H800</td> <td>1.200</td> <td>M</td> </tr> </tbody> </table>	Code	Description	Qty	UOM	IP1385A1	CORNER POLYSTYRENE PACKING 110X80X2000	0.500	M	RS1095A1	HEATING ELEMENT 1200W 230V	1	PZ	SL1045A0	S53 BLACK SILICONE - 80ML CARTRIDGE	1	PZ	VI1220A1	4,2X12 TCB SELF-TAPPIN G SCREW	2	PZ	VM1059A1	HEAT SHRINK FILM H800	1.200	M	
			Code	Description	Qty	UOM																								
			IP1385A1	CORNER POLYSTYRENE PACKING 110X80X2000	0.500	M																								
RS1095A1	HEATING ELEMENT 1200W 230V	1	PZ																											
SL1045A0	S53 BLACK SILICONE - 80ML CARTRIDGE	1	PZ																											
VI1220A1	4,2X12 TCB SELF-TAPPIN G SCREW	2	PZ																											
VM1059A1	HEAT SHRINK FILM H800	1.200	M																											
KRS1012A	1365W 120V HEATING ELEMENT KIT	<table border="1"> <thead> <tr> <th>Code</th> <th>Description</th> <th>Qty</th> <th>UOM</th> </tr> </thead> <tbody> <tr> <td>GN1326A1</td> <td>ELEMENT SEALING</td> <td>1</td> <td>PZ</td> </tr> <tr> <td>RS1012A0</td> <td>CIRCULAR ELEMENT 1365W 120V</td> <td>1</td> <td>PZ</td> </tr> <tr> <td>VI1220A1</td> <td>4,2X12 TCB SELF-TAPPIN G SCREW</td> <td>5</td> <td>PZ</td> </tr> <tr> <td>VM1794A0</td> <td>250X4.8 PA66 BLACK CLAMP</td> <td>2</td> <td>PZ</td> </tr> <tr> <td>VM2103A0</td> <td>CLAMP LOCK</td> <td>2</td> <td>PZ</td> </tr> </tbody> </table>	Code	Description	Qty	UOM	GN1326A1	ELEMENT SEALING	1	PZ	RS1012A0	CIRCULAR ELEMENT 1365W 120V	1	PZ	VI1220A1	4,2X12 TCB SELF-TAPPIN G SCREW	5	PZ	VM1794A0	250X4.8 PA66 BLACK CLAMP	2	PZ	VM2103A0	CLAMP LOCK	2	PZ				
Code	Description	Qty	UOM																											
GN1326A1	ELEMENT SEALING	1	PZ																											
RS1012A0	CIRCULAR ELEMENT 1365W 120V	1	PZ																											
VI1220A1	4,2X12 TCB SELF-TAPPIN G SCREW	5	PZ																											
VM1794A0	250X4.8 PA66 BLACK CLAMP	2	PZ																											
VM2103A0	CLAMP LOCK	2	PZ																											
KRS1011A	ROBERTA/LISA HEATING ELEMENT KIT	<table border="1"> <thead> <tr> <th>Code</th> <th>Description</th> <th>Qty</th> <th>UOM</th> </tr> </thead> <tbody> <tr> <td>GN1326A1</td> <td>ELEMENT SEALING</td> <td>1</td> <td>PZ</td> </tr> <tr> <td>RS1011A0</td> <td>2560W 220-230V HEATING ELEMENT</td> <td>1</td> <td>PZ</td> </tr> <tr> <td>SL1045A0</td> <td>S53 BLACK SILICONE - 80ML CARTRIDGE</td> <td>1</td> <td>PZ</td> </tr> <tr> <td>VI1220A1</td> <td>4,2X12 TCB SELF-TAPPIN G SCREW</td> <td>5</td> <td>PZ</td> </tr> <tr> <td>VM1794A0</td> <td>250X4.8 PA66 BLACK CLAMP</td> <td>2</td> <td>PZ</td> </tr> <tr> <td>VM2103A0</td> <td>CLAMP LOCK</td> <td>2</td> <td>PZ</td> </tr> </tbody> </table>	Code	Description	Qty	UOM	GN1326A1	ELEMENT SEALING	1	PZ	RS1011A0	2560W 220-230V HEATING ELEMENT	1	PZ	SL1045A0	S53 BLACK SILICONE - 80ML CARTRIDGE	1	PZ	VI1220A1	4,2X12 TCB SELF-TAPPIN G SCREW	5	PZ	VM1794A0	250X4.8 PA66 BLACK CLAMP	2	PZ	VM2103A0	CLAMP LOCK	2	PZ
Code	Description	Qty	UOM																											
GN1326A1	ELEMENT SEALING	1	PZ																											
RS1011A0	2560W 220-230V HEATING ELEMENT	1	PZ																											
SL1045A0	S53 BLACK SILICONE - 80ML CARTRIDGE	1	PZ																											
VI1220A1	4,2X12 TCB SELF-TAPPIN G SCREW	5	PZ																											
VM1794A0	250X4.8 PA66 BLACK CLAMP	2	PZ																											
VM2103A0	CLAMP LOCK	2	PZ																											
KRS0090A	HEATING ELEMENT 1.26KW	<table border="1"> <thead> <tr> <th>Code</th> <th>Description</th> <th>Qty</th> <th>UOM</th> </tr> </thead> <tbody> <tr> <td>GN1326A1</td> <td>ELEMENT SEALING</td> <td>1</td> <td>PZ</td> </tr> <tr> <td>RS0090A0</td> <td>CIRC. HEAT. ELEMENT 1260W 220-230</td> <td>1</td> <td>PZ</td> </tr> </tbody> </table>	Code	Description	Qty	UOM	GN1326A1	ELEMENT SEALING	1	PZ	RS0090A0	CIRC. HEAT. ELEMENT 1260W 220-230	1	PZ																
Code	Description	Qty	UOM																											
GN1326A1	ELEMENT SEALING	1	PZ																											
RS0090A0	CIRC. HEAT. ELEMENT 1260W 220-230	1	PZ																											



COMPONENT			SPARE PART																							
Code	Description	Image	Code	Description	Components list																					
GN1326A	ELEMENT SEALING		KRS0090A	HEATING ELEMENT 1.26KW	<table border="1"> <thead> <tr> <th>Code</th> <th>Description</th> <th>Qty</th> <th>UOM</th> </tr> </thead> <tbody> <tr> <td>VI1220A1</td> <td>4,2X12 TCB SELF-TAPPIN G SCREW</td> <td>3</td> <td>PZ</td> </tr> <tr> <td>VM1794A0</td> <td>250X4.8 PA66 BLACK CLAMP</td> <td>2</td> <td>PZ</td> </tr> <tr> <td>VM2103A0</td> <td>CLAMP LOCK</td> <td>2</td> <td>PZ</td> </tr> </tbody> </table>	Code	Description	Qty	UOM	VI1220A1	4,2X12 TCB SELF-TAPPIN G SCREW	3	PZ	VM1794A0	250X4.8 PA66 BLACK CLAMP	2	PZ	VM2103A0	CLAMP LOCK	2	PZ					
			Code	Description	Qty	UOM																				
			VI1220A1	4,2X12 TCB SELF-TAPPIN G SCREW	3	PZ																				
			VM1794A0	250X4.8 PA66 BLACK CLAMP	2	PZ																				
VM2103A0	CLAMP LOCK	2	PZ																							
KRS0050A	HEATING ELEMENT KIT 0.5KW	<table border="1"> <thead> <tr> <th>Code</th> <th>Description</th> <th>Qty</th> <th>UOM</th> </tr> </thead> <tbody> <tr> <td>GN1326A1</td> <td>ELEMENT SEALING</td> <td>1</td> <td>PZ</td> </tr> <tr> <td>IP1075A1</td> <td></td> <td>1</td> <td>PZ</td> </tr> <tr> <td>IP1080A1</td> <td></td> <td>1</td> <td>PZ</td> </tr> <tr> <td>RS0050A0</td> <td>HEAT. ELEMENT 500W 220-230V LIEV</td> <td>1</td> <td>PZ</td> </tr> <tr> <td>VI1220A1</td> <td>4,2X12 TCB SELF-TAPPIN G SCREW</td> <td>2</td> <td>PZ</td> </tr> </tbody> </table>	Code	Description	Qty	UOM	GN1326A1	ELEMENT SEALING	1	PZ	IP1075A1		1	PZ	IP1080A1		1	PZ	RS0050A0	HEAT. ELEMENT 500W 220-230V LIEV	1	PZ	VI1220A1	4,2X12 TCB SELF-TAPPIN G SCREW	2	PZ
Code	Description	Qty	UOM																							
GN1326A1	ELEMENT SEALING	1	PZ																							
IP1075A1		1	PZ																							
IP1080A1		1	PZ																							
RS0050A0	HEAT. ELEMENT 500W 220-230V LIEV	1	PZ																							
VI1220A1	4,2X12 TCB SELF-TAPPIN G SCREW	2	PZ																							
KRS0011A	HEATING ELEMENT 1.465KW RS0011A	<table border="1"> <thead> <tr> <th>Code</th> <th>Description</th> <th>Qty</th> <th>UOM</th> </tr> </thead> <tbody> <tr> <td>GN1326A1</td> <td>ELEMENT SEALING</td> <td>1</td> <td>PZ</td> </tr> <tr> <td>RS0011A0</td> <td>CIRC.HEAT. ELEMENT 1465W 220-230</td> <td>1</td> <td>PZ</td> </tr> <tr> <td>VI1220A1</td> <td>4,2X12 TCB SELF-TAPPIN G SCREW</td> <td>3</td> <td>PZ</td> </tr> <tr> <td>VM1794A0</td> <td>250X4.8 PA66 BLACK CLAMP</td> <td>2</td> <td>PZ</td> </tr> <tr> <td>VM2103A0</td> <td>CLAMP LOCK</td> <td>2</td> <td>PZ</td> </tr> </tbody> </table>	Code	Description	Qty	UOM	GN1326A1	ELEMENT SEALING	1	PZ	RS0011A0	CIRC.HEAT. ELEMENT 1465W 220-230	1	PZ	VI1220A1	4,2X12 TCB SELF-TAPPIN G SCREW	3	PZ	VM1794A0	250X4.8 PA66 BLACK CLAMP	2	PZ	VM2103A0	CLAMP LOCK	2	PZ
Code	Description	Qty	UOM																							
GN1326A1	ELEMENT SEALING	1	PZ																							
RS0011A0	CIRC.HEAT. ELEMENT 1465W 220-230	1	PZ																							
VI1220A1	4,2X12 TCB SELF-TAPPIN G SCREW	3	PZ																							
VM1794A0	250X4.8 PA66 BLACK CLAMP	2	PZ																							
VM2103A0	CLAMP LOCK	2	PZ																							
KRS0010A	KIT HEATING ELEMENT RS10010A	<table border="1"> <thead> <tr> <th>Code</th> <th>Description</th> <th>Qty</th> <th>UOM</th> </tr> </thead> <tbody> <tr> <td>GN1326A1</td> <td>ELEMENT SEALING</td> <td>1</td> <td>PZ</td> </tr> <tr> <td>IP1075A1</td> <td></td> <td>1</td> <td>PZ</td> </tr> <tr> <td>IP1080A1</td> <td></td> <td>5</td> <td>PZ</td> </tr> <tr> <td>RS0010A0</td> <td>CIRC.HEAT. ELEMENT 2560W - 220-230 V</td> <td>1</td> <td>PZ</td> </tr> <tr> <td>VI1220A1</td> <td>4,2X12 TCB SELF-TAPPIN G SCREW</td> <td>3</td> <td>PZ</td> </tr> </tbody> </table>	Code	Description	Qty	UOM	GN1326A1	ELEMENT SEALING	1	PZ	IP1075A1		1	PZ	IP1080A1		5	PZ	RS0010A0	CIRC.HEAT. ELEMENT 2560W - 220-230 V	1	PZ	VI1220A1	4,2X12 TCB SELF-TAPPIN G SCREW	3	PZ
Code	Description	Qty	UOM																							
GN1326A1	ELEMENT SEALING	1	PZ																							
IP1075A1		1	PZ																							
IP1080A1		5	PZ																							
RS0010A0	CIRC.HEAT. ELEMENT 2560W - 220-230 V	1	PZ																							
VI1220A1	4,2X12 TCB SELF-TAPPIN G SCREW	3	PZ																							
KG1326A	HEATING ELEMENT GASKET 5 PCS KIT	<table border="1"> <thead> <tr> <th>Code</th> <th>Description</th> <th>Qty</th> <th>UOM</th> </tr> </thead> <tbody> <tr> <td>GN1326A1</td> <td>ELEMENT SEALING</td> <td>5</td> <td>PZ</td> </tr> </tbody> </table>	Code	Description	Qty	UOM	GN1326A1	ELEMENT SEALING	5	PZ																
Code	Description	Qty	UOM																							
GN1326A1	ELEMENT SEALING	5	PZ																							

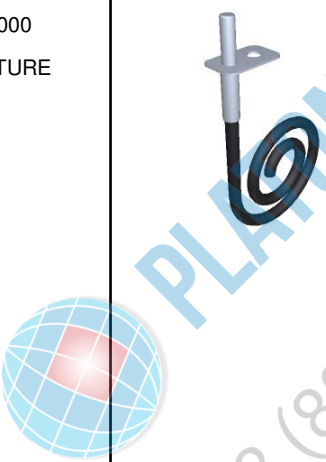

COMPONENT			SPARE PART																																		
Code	Description	Image	Code	Description	Components list																																
RS1274A	100W 60V 1 TURN FLAT ELEMENT		KRS1274A	100W MOTOR BRAKING ELEMENT KIT	<table border="1"> <thead> <tr> <th>Code</th> <th>Description</th> <th>Qty</th> <th>UOM</th> </tr> </thead> <tbody> <tr> <td>GN1326A1</td> <td>ELEMENT SEALING</td> <td>1</td> <td>PZ</td> </tr> <tr> <td>RS1274A0</td> <td>100W 60V 1 TURN FLAT ELEMENT</td> <td>1</td> <td>PZ</td> </tr> <tr> <td>SL1045A0</td> <td>S53 BLACK SILICONE - 80ML CARTRIDGE</td> <td>1</td> <td>PZ</td> </tr> <tr> <td>VI1220A1</td> <td>4,2X12 TCB SELF-TAPPIN G SCREW</td> <td>2</td> <td>PZ</td> </tr> </tbody> </table>	Code	Description	Qty	UOM	GN1326A1	ELEMENT SEALING	1	PZ	RS1274A0	100W 60V 1 TURN FLAT ELEMENT	1	PZ	SL1045A0	S53 BLACK SILICONE - 80ML CARTRIDGE	1	PZ	VI1220A1	4,2X12 TCB SELF-TAPPIN G SCREW	2	PZ												
Code	Description	Qty	UOM																																		
GN1326A1	ELEMENT SEALING	1	PZ																																		
RS1274A0	100W 60V 1 TURN FLAT ELEMENT	1	PZ																																		
SL1045A0	S53 BLACK SILICONE - 80ML CARTRIDGE	1	PZ																																		
VI1220A1	4,2X12 TCB SELF-TAPPIN G SCREW	2	PZ																																		
GN1285A	NTC TEMPERATURE PROBE SEALING		KTR1106A	5-5E S. L2000 CHAMBER TEMP. PROBE KIT	<table border="1"> <thead> <tr> <th>Code</th> <th>Description</th> <th>Qty</th> <th>UOM</th> </tr> </thead> <tbody> <tr> <td>GN1285A0</td> <td>NTC TEMPERATUR E PROBE SEALING</td> <td>1</td> <td>PZ</td> </tr> <tr> <td>SL1045A0</td> <td>S53 BLACK SILICONE - 80ML CARTRIDGE</td> <td>1</td> <td>PZ</td> </tr> <tr> <td>TR1106A3</td> <td>PT100 L=2000 TEMPERATUR E PROBE</td> <td>1</td> <td>PZ</td> </tr> <tr> <td>VI1220A1</td> <td>4,2X12 TCB SELF-TAPPIN G SCREW</td> <td>2</td> <td>PZ</td> </tr> <tr> <td>VM1465A0</td> <td>CHEFTOP TEMPERATUR E PROBE COVER</td> <td>1</td> <td>PZ</td> </tr> </tbody> </table>	Code	Description	Qty	UOM	GN1285A0	NTC TEMPERATUR E PROBE SEALING	1	PZ	SL1045A0	S53 BLACK SILICONE - 80ML CARTRIDGE	1	PZ	TR1106A3	PT100 L=2000 TEMPERATUR E PROBE	1	PZ	VI1220A1	4,2X12 TCB SELF-TAPPIN G SCREW	2	PZ	VM1465A0	CHEFTOP TEMPERATUR E PROBE COVER	1	PZ								
					Code	Description	Qty	UOM																													
GN1285A0	NTC TEMPERATUR E PROBE SEALING	1	PZ																																		
SL1045A0	S53 BLACK SILICONE - 80ML CARTRIDGE	1	PZ																																		
TR1106A3	PT100 L=2000 TEMPERATUR E PROBE	1	PZ																																		
VI1220A1	4,2X12 TCB SELF-TAPPIN G SCREW	2	PZ																																		
VM1465A0	CHEFTOP TEMPERATUR E PROBE COVER	1	PZ																																		
			KTR1105A	PT100 L1000 TEMPERATURE PROBE KIT	<table border="1"> <thead> <tr> <th>Code</th> <th>Description</th> <th>Qty</th> <th>UOM</th> </tr> </thead> <tbody> <tr> <td>GN1120A0</td> <td>TEMPERATUR E PROBE NTC SEAL</td> <td>1</td> <td>PZ</td> </tr> <tr> <td>GN1285A0</td> <td>NTC TEMPERATUR E PROBE SEALING</td> <td>1</td> <td>PZ</td> </tr> <tr> <td>SL1045A0</td> <td>S53 BLACK SILICONE - 80ML CARTRIDGE</td> <td>1</td> <td>PZ</td> </tr> <tr> <td>TR1105A3</td> <td>L=1000 PT1000 TEMPERATUR E PROBE</td> <td>1</td> <td>PZ</td> </tr> <tr> <td>TR1105A4</td> <td></td> <td>1</td> <td>PZ</td> </tr> <tr> <td>VI1220A1</td> <td>4,2X12 TCB SELF-TAPPIN G SCREW</td> <td>2</td> <td>PZ</td> </tr> <tr> <td>VM1465A0</td> <td>CHEFTOP TEMPERATUR E PROBE COVER</td> <td>1</td> <td>PZ</td> </tr> </tbody> </table>	Code	Description	Qty	UOM	GN1120A0	TEMPERATUR E PROBE NTC SEAL	1	PZ	GN1285A0	NTC TEMPERATUR E PROBE SEALING	1	PZ	SL1045A0	S53 BLACK SILICONE - 80ML CARTRIDGE	1	PZ	TR1105A3	L=1000 PT1000 TEMPERATUR E PROBE	1	PZ	TR1105A4		1	PZ	VI1220A1	4,2X12 TCB SELF-TAPPIN G SCREW	2	PZ	VM1465A0	CHEFTOP TEMPERATUR E PROBE COVER	1	PZ
Code	Description	Qty	UOM																																		
GN1120A0	TEMPERATUR E PROBE NTC SEAL	1	PZ																																		
GN1285A0	NTC TEMPERATUR E PROBE SEALING	1	PZ																																		
SL1045A0	S53 BLACK SILICONE - 80ML CARTRIDGE	1	PZ																																		
TR1105A3	L=1000 PT1000 TEMPERATUR E PROBE	1	PZ																																		
TR1105A4		1	PZ																																		
VI1220A1	4,2X12 TCB SELF-TAPPIN G SCREW	2	PZ																																		
VM1465A0	CHEFTOP TEMPERATUR E PROBE COVER	1	PZ																																		

COMPONENT			SPARE PART																														
Code	Description	Image	Code	Description	Components list																												
GN1285A	NTC TEMPERATURE PROBE SEALING		KTR1096A	NTC 150 L=1500 TEMPERATURE PROBE KIT	<table border="1"> <thead> <tr> <th>Code</th> <th>Description</th> <th>Qty</th> <th>UOM</th> </tr> </thead> <tbody> <tr> <td>GN1120A0</td> <td>TEMPERATUR E PROBE NTC SEAL</td> <td>1</td> <td>PZ</td> </tr> <tr> <td>GN1285A0</td> <td>NTC TEMPERATUR E PROBE SEALING</td> <td>2</td> <td>PZ</td> </tr> <tr> <td>SL1045A0</td> <td>S53 BLACK SILICONE - 80ML CARTRIDGE</td> <td>1</td> <td>PZ</td> </tr> <tr> <td>TR1096A0</td> <td>TEMPERATUR E PROBE NTC 150 L=1500</td> <td>1</td> <td>PZ</td> </tr> <tr> <td>VI1220A1</td> <td>4,2X12 TCB SELF-TAPPIN G SCREW</td> <td>2</td> <td>PZ</td> </tr> <tr> <td>VM1465A0</td> <td>CHEFTOP TEMPERATUR E PROBE COVER</td> <td>1</td> <td>PZ</td> </tr> </tbody> </table>	Code	Description	Qty	UOM	GN1120A0	TEMPERATUR E PROBE NTC SEAL	1	PZ	GN1285A0	NTC TEMPERATUR E PROBE SEALING	2	PZ	SL1045A0	S53 BLACK SILICONE - 80ML CARTRIDGE	1	PZ	TR1096A0	TEMPERATUR E PROBE NTC 150 L=1500	1	PZ	VI1220A1	4,2X12 TCB SELF-TAPPIN G SCREW	2	PZ	VM1465A0	CHEFTOP TEMPERATUR E PROBE COVER	1	PZ
			Code	Description	Qty	UOM																											
			GN1120A0	TEMPERATUR E PROBE NTC SEAL	1	PZ																											
GN1285A0	NTC TEMPERATUR E PROBE SEALING	2	PZ																														
SL1045A0	S53 BLACK SILICONE - 80ML CARTRIDGE	1	PZ																														
TR1096A0	TEMPERATUR E PROBE NTC 150 L=1500	1	PZ																														
VI1220A1	4,2X12 TCB SELF-TAPPIN G SCREW	2	PZ																														
VM1465A0	CHEFTOP TEMPERATUR E PROBE COVER	1	PZ																														
KTR1095A	NTC 150 L=1050 TEMPERATURE PROBE KIT	<table border="1"> <thead> <tr> <th>Code</th> <th>Description</th> <th>Qty</th> <th>UOM</th> </tr> </thead> <tbody> <tr> <td>GN1120A0</td> <td>TEMPERATUR E PROBE NTC SEAL</td> <td>1</td> <td>PZ</td> </tr> <tr> <td>GN1285A0</td> <td>NTC TEMPERATUR E PROBE SEALING</td> <td>1</td> <td>PZ</td> </tr> <tr> <td>SL1045A0</td> <td>S53 BLACK SILICONE - 80ML CARTRIDGE</td> <td>1</td> <td>PZ</td> </tr> <tr> <td>TR1095A0</td> <td>TEMPERATUR E PROBE NTC 150 L=1050</td> <td>1</td> <td>PZ</td> </tr> <tr> <td>VI1220A1</td> <td>4,2X12 TCB SELF-TAPPIN G SCREW</td> <td>2</td> <td>PZ</td> </tr> <tr> <td>VM1465A0</td> <td>CHEFTOP TEMPERATUR E PROBE COVER</td> <td>1</td> <td>PZ</td> </tr> </tbody> </table>	Code	Description	Qty	UOM	GN1120A0	TEMPERATUR E PROBE NTC SEAL	1	PZ	GN1285A0	NTC TEMPERATUR E PROBE SEALING	1	PZ	SL1045A0	S53 BLACK SILICONE - 80ML CARTRIDGE	1	PZ	TR1095A0	TEMPERATUR E PROBE NTC 150 L=1050	1	PZ	VI1220A1	4,2X12 TCB SELF-TAPPIN G SCREW	2	PZ	VM1465A0	CHEFTOP TEMPERATUR E PROBE COVER	1	PZ			
Code	Description	Qty	UOM																														
GN1120A0	TEMPERATUR E PROBE NTC SEAL	1	PZ																														
GN1285A0	NTC TEMPERATUR E PROBE SEALING	1	PZ																														
SL1045A0	S53 BLACK SILICONE - 80ML CARTRIDGE	1	PZ																														
TR1095A0	TEMPERATUR E PROBE NTC 150 L=1050	1	PZ																														
VI1220A1	4,2X12 TCB SELF-TAPPIN G SCREW	2	PZ																														
VM1465A0	CHEFTOP TEMPERATUR E PROBE COVER	1	PZ																														
KTR1002A	PT100 L1000 UL TEMPERATURE PROBE KIT	<table border="1"> <thead> <tr> <th>Code</th> <th>Description</th> <th>Qty</th> <th>UOM</th> </tr> </thead> <tbody> <tr> <td>GN1285A0</td> <td>NTC TEMPERATUR E PROBE SEALING</td> <td>2</td> <td>PZ</td> </tr> <tr> <td>SL1045A0</td> <td>S53 BLACK SILICONE - 80ML CARTRIDGE</td> <td>1</td> <td>PZ</td> </tr> </tbody> </table>	Code	Description	Qty	UOM	GN1285A0	NTC TEMPERATUR E PROBE SEALING	2	PZ	SL1045A0	S53 BLACK SILICONE - 80ML CARTRIDGE	1	PZ																			
Code	Description	Qty	UOM																														
GN1285A0	NTC TEMPERATUR E PROBE SEALING	2	PZ																														
SL1045A0	S53 BLACK SILICONE - 80ML CARTRIDGE	1	PZ																														

COMPONENT			SPARE PART																														
Code	Description	Image	Code	Description	Components list																												
GN1285A	NTC TEMPERATURE PROBE SEALING		KTR1002A	PT100 L1000 UL TEMPERATURE PROBE KIT	<table border="1"> <thead> <tr> <th>Code</th> <th>Description</th> <th>Qty</th> <th>UOM</th> </tr> </thead> <tbody> <tr> <td>TR1002A0</td> <td>TEMPERATUR E PROBE UL PT100 L1000</td> <td>1</td> <td>PZ</td> </tr> <tr> <td>TR1002A1</td> <td></td> <td>1</td> <td>PZ</td> </tr> <tr> <td>VI1220A1</td> <td>4,2X12 TCB SELF-TAPPIN G SCREW</td> <td>2</td> <td>PZ</td> </tr> <tr> <td>VM1465A0</td> <td>CHEFTOP TEMPERATUR E PROBE COVER</td> <td>1</td> <td>PZ</td> </tr> </tbody> </table>	Code	Description	Qty	UOM	TR1002A0	TEMPERATUR E PROBE UL PT100 L1000	1	PZ	TR1002A1		1	PZ	VI1220A1	4,2X12 TCB SELF-TAPPIN G SCREW	2	PZ	VM1465A0	CHEFTOP TEMPERATUR E PROBE COVER	1	PZ								
Code	Description	Qty	UOM																														
TR1002A0	TEMPERATUR E PROBE UL PT100 L1000	1	PZ																														
TR1002A1		1	PZ																														
VI1220A1	4,2X12 TCB SELF-TAPPIN G SCREW	2	PZ																														
VM1465A0	CHEFTOP TEMPERATUR E PROBE COVER	1	PZ																														
TR1106A	PT100 L=2000 TEMPERATURE PROBE		KTR1106B	MIND.MAPS L2000 CHAMBER TEMP. PROBE KIT	<table border="1"> <thead> <tr> <th>Code</th> <th>Description</th> <th>Qty</th> <th>UOM</th> </tr> </thead> <tbody> <tr> <td>GN1285A0</td> <td>NTC TEMPERATUR E PROBE SEALING</td> <td>1</td> <td>PZ</td> </tr> <tr> <td>SL1045A0</td> <td>S53 BLACK SILICONE - 80ML CARTRIDGE</td> <td>1</td> <td>PZ</td> </tr> <tr> <td>TR1106B0</td> <td></td> <td>1</td> <td>PZ</td> </tr> <tr> <td>VI1220A1</td> <td>4,2X12 TCB SELF-TAPPIN G SCREW</td> <td>2</td> <td>PZ</td> </tr> <tr> <td>VM1464A0</td> <td>CT BT TEMPERATUR E PROBE COVER</td> <td>1</td> <td>PZ</td> </tr> <tr> <td>VM1465A0</td> <td>CHEFTOP TEMPERATUR E PROBE COVER</td> <td>1</td> <td>PZ</td> </tr> </tbody> </table>	Code	Description	Qty	UOM	GN1285A0	NTC TEMPERATUR E PROBE SEALING	1	PZ	SL1045A0	S53 BLACK SILICONE - 80ML CARTRIDGE	1	PZ	TR1106B0		1	PZ	VI1220A1	4,2X12 TCB SELF-TAPPIN G SCREW	2	PZ	VM1464A0	CT BT TEMPERATUR E PROBE COVER	1	PZ	VM1465A0	CHEFTOP TEMPERATUR E PROBE COVER	1	PZ
Code	Description	Qty	UOM																														
GN1285A0	NTC TEMPERATUR E PROBE SEALING	1	PZ																														
SL1045A0	S53 BLACK SILICONE - 80ML CARTRIDGE	1	PZ																														
TR1106B0		1	PZ																														
VI1220A1	4,2X12 TCB SELF-TAPPIN G SCREW	2	PZ																														
VM1464A0	CT BT TEMPERATUR E PROBE COVER	1	PZ																														
VM1465A0	CHEFTOP TEMPERATUR E PROBE COVER	1	PZ																														
			KTR1106A	5-5E S. L2000 CHAMBER TEMP. PROBE KIT	<table border="1"> <thead> <tr> <th>Code</th> <th>Description</th> <th>Qty</th> <th>UOM</th> </tr> </thead> <tbody> <tr> <td>GN1285A0</td> <td>NTC TEMPERATUR E PROBE SEALING</td> <td>1</td> <td>PZ</td> </tr> <tr> <td>SL1045A0</td> <td>S53 BLACK SILICONE - 80ML CARTRIDGE</td> <td>1</td> <td>PZ</td> </tr> <tr> <td>TR1106A3</td> <td>PT100 L=2000 TEMPERATUR E PROBE</td> <td>1</td> <td>PZ</td> </tr> <tr> <td>VI1220A1</td> <td>4,2X12 TCB SELF-TAPPIN G SCREW</td> <td>2</td> <td>PZ</td> </tr> <tr> <td>VM1465A0</td> <td>CHEFTOP TEMPERATUR E PROBE COVER</td> <td>1</td> <td>PZ</td> </tr> </tbody> </table>	Code	Description	Qty	UOM	GN1285A0	NTC TEMPERATUR E PROBE SEALING	1	PZ	SL1045A0	S53 BLACK SILICONE - 80ML CARTRIDGE	1	PZ	TR1106A3	PT100 L=2000 TEMPERATUR E PROBE	1	PZ	VI1220A1	4,2X12 TCB SELF-TAPPIN G SCREW	2	PZ	VM1465A0	CHEFTOP TEMPERATUR E PROBE COVER	1	PZ				
Code	Description	Qty	UOM																														
GN1285A0	NTC TEMPERATUR E PROBE SEALING	1	PZ																														
SL1045A0	S53 BLACK SILICONE - 80ML CARTRIDGE	1	PZ																														
TR1106A3	PT100 L=2000 TEMPERATUR E PROBE	1	PZ																														
VI1220A1	4,2X12 TCB SELF-TAPPIN G SCREW	2	PZ																														
VM1465A0	CHEFTOP TEMPERATUR E PROBE COVER	1	PZ																														



COMPONENT			SPARE PART																														
Code	Description	Image	Code	Description	Components list																												
VM1464A	CT BT TEMPERATURE PROBE COVER		KVM1464A	CT BT TEMPERATURE PROBE COVER KIT	<table border="1"> <thead> <tr> <th>Code</th> <th>Description</th> <th>Qty</th> <th>UOM</th> </tr> </thead> <tbody> <tr> <td>VM1464A0</td> <td>CT BT TEMPERATUR E PROBE COVER</td> <td>1</td> <td>PZ</td> </tr> </tbody> </table>	Code	Description	Qty	UOM	VM1464A0	CT BT TEMPERATUR E PROBE COVER	1	PZ																				
Code	Description	Qty	UOM																														
VM1464A0	CT BT TEMPERATUR E PROBE COVER	1	PZ																														
TR1003A	PT100 L2000 TEMPERATURE PROBE-US VERSION		KTR1003B	US MM L2000 CHAMBER TEMP. PROBE KIT	<table border="1"> <thead> <tr> <th>Code</th> <th>Description</th> <th>Qty</th> <th>UOM</th> </tr> </thead> <tbody> <tr> <td>GN1285A0</td> <td>NTC TEMPERATUR E PROBE SEALING</td> <td>1</td> <td>PZ</td> </tr> <tr> <td>SL1045A0</td> <td>S53 BLACK SILICONE - 80ML CARTRIDGE</td> <td>1</td> <td>PZ</td> </tr> <tr> <td>TR1003B0</td> <td></td> <td>1</td> <td>PZ</td> </tr> <tr> <td>VI1220A1</td> <td>4,2X12 TCB SELF-TAPPIN G SCREW</td> <td>2</td> <td>PZ</td> </tr> <tr> <td>VM1464A0</td> <td>CT BT TEMPERATUR E PROBE COVER</td> <td>1</td> <td>PZ</td> </tr> <tr> <td>VM1465A0</td> <td>CHEFTOP TEMPERATUR E PROBE COVER</td> <td>1</td> <td>PZ</td> </tr> </tbody> </table>	Code	Description	Qty	UOM	GN1285A0	NTC TEMPERATUR E PROBE SEALING	1	PZ	SL1045A0	S53 BLACK SILICONE - 80ML CARTRIDGE	1	PZ	TR1003B0		1	PZ	VI1220A1	4,2X12 TCB SELF-TAPPIN G SCREW	2	PZ	VM1464A0	CT BT TEMPERATUR E PROBE COVER	1	PZ	VM1465A0	CHEFTOP TEMPERATUR E PROBE COVER	1	PZ
Code	Description	Qty	UOM																														
GN1285A0	NTC TEMPERATUR E PROBE SEALING	1	PZ																														
SL1045A0	S53 BLACK SILICONE - 80ML CARTRIDGE	1	PZ																														
TR1003B0		1	PZ																														
VI1220A1	4,2X12 TCB SELF-TAPPIN G SCREW	2	PZ																														
VM1464A0	CT BT TEMPERATUR E PROBE COVER	1	PZ																														
VM1465A0	CHEFTOP TEMPERATUR E PROBE COVER	1	PZ																														
GN1531A	THERMOSTAT BULB INLET SEALING		KTR1136A	330 °C SAFETY THERMOSTAT KIT	<table border="1"> <thead> <tr> <th>Code</th> <th>Description</th> <th>Qty</th> <th>UOM</th> </tr> </thead> <tbody> <tr> <td>0H7030A0</td> <td>THERMOSTAT BULB INLET COVER</td> <td>1</td> <td>PZ</td> </tr> <tr> <td>GN1531A0</td> <td>THERMOSTAT BULB INLET SEALING</td> <td>1</td> <td>PZ</td> </tr> <tr> <td>SL1045A0</td> <td>S53 BLACK SILICONE - 80ML CARTRIDGE</td> <td>1</td> <td>PZ</td> </tr> <tr> <td>TR1136A0</td> <td>330 °C 1 POLE SAFETY THERMOSTAT</td> <td>1</td> <td>PZ</td> </tr> <tr> <td>VI1220A1</td> <td>4,2X12 TCB SELF-TAPPIN G SCREW</td> <td>3</td> <td>PZ</td> </tr> </tbody> </table>	Code	Description	Qty	UOM	0H7030A0	THERMOSTAT BULB INLET COVER	1	PZ	GN1531A0	THERMOSTAT BULB INLET SEALING	1	PZ	SL1045A0	S53 BLACK SILICONE - 80ML CARTRIDGE	1	PZ	TR1136A0	330 °C 1 POLE SAFETY THERMOSTAT	1	PZ	VI1220A1	4,2X12 TCB SELF-TAPPIN G SCREW	3	PZ				
Code	Description	Qty	UOM																														
0H7030A0	THERMOSTAT BULB INLET COVER	1	PZ																														
GN1531A0	THERMOSTAT BULB INLET SEALING	1	PZ																														
SL1045A0	S53 BLACK SILICONE - 80ML CARTRIDGE	1	PZ																														
TR1136A0	330 °C 1 POLE SAFETY THERMOSTAT	1	PZ																														
VI1220A1	4,2X12 TCB SELF-TAPPIN G SCREW	3	PZ																														

COMPONENT			SPARE PART																																										
Code	Description	Image	Code	Description	Components list																																								
0H7030A	THERMOSTAT BULB INLET COVER		K0H7030A	THERMOSTAT BULB INLET COVER KIT	<table border="1"> <thead> <tr> <th>Code</th> <th>Description</th> <th>Qty</th> <th>UOM</th> </tr> </thead> <tbody> <tr> <td>0H7030A0</td> <td>THERMOSTAT BULB INLET COVER</td> <td>1</td> <td>PZ</td> </tr> </tbody> </table>	Code	Description	Qty	UOM	0H7030A0	THERMOSTAT BULB INLET COVER	1	PZ																																
Code	Description	Qty	UOM																																										
0H7030A0	THERMOSTAT BULB INLET COVER	1	PZ																																										
VL1037A	WASHING SYSTEM ROTOR		KVL1037A	WASHING SYSTEM ROTOR KIT	<table border="1"> <thead> <tr> <th>Code</th> <th>Description</th> <th>Qty</th> <th>UOM</th> </tr> </thead> <tbody> <tr> <td>GN1416B0</td> <td>WASHING SYSTEM ROTOR BEARING</td> <td>1</td> <td>PZ</td> </tr> <tr> <td>TF1065B0</td> <td>WASHING SYSTEM ROTOR PIVOT</td> <td>1</td> <td>PZ</td> </tr> <tr> <td>TF1066A1</td> <td>WASHING SYSTEM ROTOR BUSH</td> <td>1</td> <td>PZ</td> </tr> <tr> <td>UG1005B1</td> <td>LONG RAY ROTOR WATER NOZZL</td> <td>1</td> <td>PZ</td> </tr> <tr> <td>UG1006B3</td> <td>LONG RAY ROTOR WATER NOZZL</td> <td>1</td> <td>PZ</td> </tr> <tr> <td>VI1220A1</td> <td>4,2X12 TCB SELF-TAPPIN G SCREW</td> <td>6</td> <td>PZ</td> </tr> <tr> <td>VM1955C0</td> <td>WASHING SYSTEM ROTOR</td> <td>1</td> <td>PZ</td> </tr> <tr> <td>VM1985C1</td> <td>WASHING SYSTEM ROTOR COVE</td> <td>1</td> <td>PZ</td> </tr> <tr> <td>VM1986A0</td> <td>NOZZLE COVE</td> <td>1</td> <td>PZ</td> </tr> </tbody> </table>	Code	Description	Qty	UOM	GN1416B0	WASHING SYSTEM ROTOR BEARING	1	PZ	TF1065B0	WASHING SYSTEM ROTOR PIVOT	1	PZ	TF1066A1	WASHING SYSTEM ROTOR BUSH	1	PZ	UG1005B1	LONG RAY ROTOR WATER NOZZL	1	PZ	UG1006B3	LONG RAY ROTOR WATER NOZZL	1	PZ	VI1220A1	4,2X12 TCB SELF-TAPPIN G SCREW	6	PZ	VM1955C0	WASHING SYSTEM ROTOR	1	PZ	VM1985C1	WASHING SYSTEM ROTOR COVE	1	PZ	VM1986A0	NOZZLE COVE	1	PZ
Code	Description	Qty	UOM																																										
GN1416B0	WASHING SYSTEM ROTOR BEARING	1	PZ																																										
TF1065B0	WASHING SYSTEM ROTOR PIVOT	1	PZ																																										
TF1066A1	WASHING SYSTEM ROTOR BUSH	1	PZ																																										
UG1005B1	LONG RAY ROTOR WATER NOZZL	1	PZ																																										
UG1006B3	LONG RAY ROTOR WATER NOZZL	1	PZ																																										
VI1220A1	4,2X12 TCB SELF-TAPPIN G SCREW	6	PZ																																										
VM1955C0	WASHING SYSTEM ROTOR	1	PZ																																										
VM1985C1	WASHING SYSTEM ROTOR COVE	1	PZ																																										
VM1986A0	NOZZLE COVE	1	PZ																																										
0H2551A	XBC/XVC ST.STEEL DRAIN COVER		0H2551A0	XBC/XVC ST.STEEL DRAIN COVER																																									



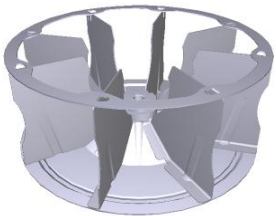
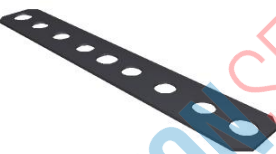
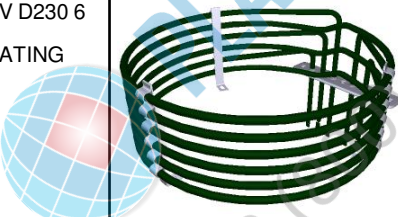

COMPONENT			SPARE PART																										
Code	Description	Image	Code	Description	Components list																								
0H7320A	6 S. VENTURI PIPE SUPPORT		0H7320A0	6 S. VENTURI PIPE SUPPORT																									
VM1820A	LATERAL SUPPORTS M6 FIXING BOLT		KVM1820A	THUMB SCREW 10PCS KIT	<table border="1"> <thead> <tr> <th>Code</th> <th>Description</th> <th>Qty</th> <th>UOM</th> </tr> </thead> <tbody> <tr> <td>VM1820A0</td> <td>LATERAL SUPPORTS M6 FIXING BOLT</td> <td>10</td> <td>PZ</td> </tr> </tbody> </table>	Code	Description	Qty	UOM	VM1820A0	LATERAL SUPPORTS M6 FIXING BOLT	10	PZ																
Code	Description	Qty	UOM																										
VM1820A0	LATERAL SUPPORTS M6 FIXING BOLT	10	PZ																										
RC1019A	D=10 ELASTIC CLAM		KRC1019A	Ø10 ZINC PLATED ELASTIC CLAMP 15 PCS KIT	<table border="1"> <thead> <tr> <th>Code</th> <th>Description</th> <th>Qty</th> <th>UOM</th> </tr> </thead> <tbody> <tr> <td>RC1019A0</td> <td>D=10 ELASTIC CLAMP</td> <td>15</td> <td>PZ</td> </tr> </tbody> </table>	Code	Description	Qty	UOM	RC1019A0	D=10 ELASTIC CLAMP	15	PZ																
Code	Description	Qty	UOM																										
RC1019A0	D=10 ELASTIC CLAMP	15	PZ																										
VM2331A	FAN GUARD-TRAYS HOLDER PIN		KVM2331A	KIT FAN GUARD-TRAYS HOLDER PIN	<table border="1"> <thead> <tr> <th>Code</th> <th>Description</th> <th>Qty</th> <th>UOM</th> </tr> </thead> <tbody> <tr> <td>VM2331A0</td> <td>FAN GUARD-TRAY S HOLDER PIN</td> <td>4</td> <td>PZ</td> </tr> </tbody> </table>	Code	Description	Qty	UOM	VM2331A0	FAN GUARD-TRAY S HOLDER PIN	4	PZ																
Code	Description	Qty	UOM																										
VM2331A0	FAN GUARD-TRAY S HOLDER PIN	4	PZ																										
MT1012A	330W 230V MOTOR		KMT1012A	MIND.MAPS 330W 230V MOTOR KIT	<table border="1"> <thead> <tr> <th>Code</th> <th>Description</th> <th>Qty</th> <th>UOM</th> </tr> </thead> <tbody> <tr> <td>0H4305A1</td> <td>ST. STEEL MOTOR SHAFT SEALING DISC</td> <td>1</td> <td>PZ</td> </tr> <tr> <td>GN1140A2</td> <td>MOTOR HOLDER GASKET</td> <td>1</td> <td>PZ</td> </tr> <tr> <td>MT1012A0</td> <td>330W 230V MOTOR</td> <td>1</td> <td>PZ</td> </tr> <tr> <td>VE1550A0</td> <td>5X3 MM NEODYMIUM MAGNET</td> <td>1</td> <td>PZ</td> </tr> <tr> <td>VI1077A1</td> <td>SCREW M6X12 TE INOX</td> <td>1</td> <td>PZ</td> </tr> </tbody> </table>	Code	Description	Qty	UOM	0H4305A1	ST. STEEL MOTOR SHAFT SEALING DISC	1	PZ	GN1140A2	MOTOR HOLDER GASKET	1	PZ	MT1012A0	330W 230V MOTOR	1	PZ	VE1550A0	5X3 MM NEODYMIUM MAGNET	1	PZ	VI1077A1	SCREW M6X12 TE INOX	1	PZ
Code	Description	Qty	UOM																										
0H4305A1	ST. STEEL MOTOR SHAFT SEALING DISC	1	PZ																										
GN1140A2	MOTOR HOLDER GASKET	1	PZ																										
MT1012A0	330W 230V MOTOR	1	PZ																										
VE1550A0	5X3 MM NEODYMIUM MAGNET	1	PZ																										
VI1077A1	SCREW M6X12 TE INOX	1	PZ																										

COMPONENT			SPARE PART																										
Code	Description	Image	Code	Description	Components list																								
MT1012A	330W 230V MOTOR		KMT1012A	MIND.MAPS 330W 230V MOTOR KIT	<table border="1"> <thead> <tr> <th>Code</th> <th>Description</th> <th>Qty</th> <th>UOM</th> </tr> </thead> <tbody> <tr> <td>VI1521A0</td> <td>STAINLESS STEEL WASHER D=6 6592</td> <td>1</td> <td>PZ</td> </tr> <tr> <td>VI1966A0</td> <td>M4X14 FLATHEAD SCREW</td> <td>1</td> <td>PZ</td> </tr> <tr> <td>VM1635A0</td> <td>MAGNET HOLDING DIS</td> <td>1</td> <td>PZ</td> </tr> <tr> <td>VM1794A0</td> <td>250X4.8 PA66 BLACK CLAMP</td> <td>4</td> <td>PZ</td> </tr> <tr> <td>VM2103A0</td> <td>CLAMP LOCK</td> <td>4</td> <td>PZ</td> </tr> </tbody> </table>	Code	Description	Qty	UOM	VI1521A0	STAINLESS STEEL WASHER D=6 6592	1	PZ	VI1966A0	M4X14 FLATHEAD SCREW	1	PZ	VM1635A0	MAGNET HOLDING DIS	1	PZ	VM1794A0	250X4.8 PA66 BLACK CLAMP	4	PZ	VM2103A0	CLAMP LOCK	4	PZ
Code	Description	Qty	UOM																										
VI1521A0	STAINLESS STEEL WASHER D=6 6592	1	PZ																										
VI1966A0	M4X14 FLATHEAD SCREW	1	PZ																										
VM1635A0	MAGNET HOLDING DIS	1	PZ																										
VM1794A0	250X4.8 PA66 BLACK CLAMP	4	PZ																										
VM2103A0	CLAMP LOCK	4	PZ																										
0H7170A	MM MOTOR GLASS WOOL PLATE		0H7170A0	MM MOTOR GLASS WOOL PLATE																									
GN1140A	MOTOR HOLDER GASKET		KG1140A	5 PCS. MOTOR SUPP. GASKET KIT	<table border="1"> <thead> <tr> <th>Code</th> <th>Description</th> <th>Qty</th> <th>UOM</th> </tr> </thead> <tbody> <tr> <td>GN1140A2</td> <td>MOTOR HOLDER GASKET</td> <td>5</td> <td>PZ</td> </tr> </tbody> </table>	Code	Description	Qty	UOM	GN1140A2	MOTOR HOLDER GASKET	5	PZ																
Code	Description	Qty	UOM																										
GN1140A2	MOTOR HOLDER GASKET	5	PZ																										
0H4305A	ST. STEEL MOTOR SHAFT SEALING DIS		K0H4305A	SEALING DISC FOR MOTOR SHAFT KIT	<table border="1"> <thead> <tr> <th>Code</th> <th>Description</th> <th>Qty</th> <th>UOM</th> </tr> </thead> <tbody> <tr> <td>0H4305A1</td> <td>ST. STEEL MOTOR SHAFT SEALING DISC</td> <td>1</td> <td>PZ</td> </tr> <tr> <td>GN1140A2</td> <td>MOTOR HOLDER GASKET</td> <td>1</td> <td>PZ</td> </tr> <tr> <td>SL1045A0</td> <td>S53 BLACK SILICONE - 80ML CARTRIDGE</td> <td>1</td> <td>PZ</td> </tr> <tr> <td>VI1220A1</td> <td>4,2X12 TCB SELF-TAPPIN G SCREW</td> <td>3</td> <td>PZ</td> </tr> </tbody> </table>	Code	Description	Qty	UOM	0H4305A1	ST. STEEL MOTOR SHAFT SEALING DISC	1	PZ	GN1140A2	MOTOR HOLDER GASKET	1	PZ	SL1045A0	S53 BLACK SILICONE - 80ML CARTRIDGE	1	PZ	VI1220A1	4,2X12 TCB SELF-TAPPIN G SCREW	3	PZ				
Code	Description	Qty	UOM																										
0H4305A1	ST. STEEL MOTOR SHAFT SEALING DISC	1	PZ																										
GN1140A2	MOTOR HOLDER GASKET	1	PZ																										
SL1045A0	S53 BLACK SILICONE - 80ML CARTRIDGE	1	PZ																										
VI1220A1	4,2X12 TCB SELF-TAPPIN G SCREW	3	PZ																										



COMPONENT			SPARE PART																																										
Code	Description	Image	Code	Description	Components list																																								
VN1170B	D195 H80 8 BLADES FAN+RING		KVN1170B	D195 H80 8 BLADES FAN + RING KIT	<table border="1"> <thead> <tr> <th>Code</th> <th>Description</th> <th>Qty</th> <th>UOM</th> </tr> </thead> <tbody> <tr> <td>VI1077A1</td> <td>SCREW M6X12 TE INOX</td> <td>1</td> <td>PZ</td> </tr> <tr> <td>VI1521A0</td> <td>STAINLESS STEEL WASHER D=6 6592</td> <td>1</td> <td>PZ</td> </tr> <tr> <td>VN1170B0</td> <td>D195 H80 8 BLADES FAN+RING</td> <td>1</td> <td>PZ</td> </tr> </tbody> </table>	Code	Description	Qty	UOM	VI1077A1	SCREW M6X12 TE INOX	1	PZ	VI1521A0	STAINLESS STEEL WASHER D=6 6592	1	PZ	VN1170B0	D195 H80 8 BLADES FAN+RING	1	PZ																								
					Code	Description	Qty	UOM																																					
VI1077A1	SCREW M6X12 TE INOX	1	PZ																																										
VI1521A0	STAINLESS STEEL WASHER D=6 6592	1	PZ																																										
VN1170B0	D195 H80 8 BLADES FAN+RING	1	PZ																																										
GN1085A	141X24 HEATING ELEMENT GASKET		KGN1085A	HEATING ELEMENT GASKET KIT	<table border="1"> <thead> <tr> <th>Code</th> <th>Description</th> <th>Qty</th> <th>UOM</th> </tr> </thead> <tbody> <tr> <td>GN1085A2</td> <td>141X24 HEATING ELEMENT GASKET</td> <td>1</td> <td>PZ</td> </tr> </tbody> </table>	Code	Description	Qty	UOM	GN1085A2	141X24 HEATING ELEMENT GASKET	1	PZ																																
Code	Description	Qty	UOM																																										
GN1085A2	141X24 HEATING ELEMENT GASKET	1	PZ																																										
RS1225A	4700W 230V D230 6 TURNS HEATING ELEMENT		KRS1225A	4.7KW HEATING ELEMENT KIT	<table border="1"> <thead> <tr> <th>Code</th> <th>Description</th> <th>Qty</th> <th>UOM</th> </tr> </thead> <tbody> <tr> <td>GN1085A2</td> <td>141X24 HEATING ELEMENT GASKET</td> <td>1</td> <td>PZ</td> </tr> <tr> <td>RS1225A1</td> <td>4700W 230V D230 6 TURNS HEATING ELEMENT</td> <td>1</td> <td>PZ</td> </tr> <tr> <td>SL1045A0</td> <td>S53 BLACK SILICONE - 80ML CARTRIDGE</td> <td>1</td> <td>PZ</td> </tr> <tr> <td>VI1032A0</td> <td>SCREW M4X16 TCB+ INOX</td> <td>1</td> <td>PZ</td> </tr> <tr> <td>VI1075A0</td> <td>NUT M4 H=4 UNI5587 INOX</td> <td>1</td> <td>PZ</td> </tr> <tr> <td>VI1220A1</td> <td>4,2X12 TCB SELF-TAPPIN G SCREW</td> <td>6</td> <td>PZ</td> </tr> <tr> <td>VI1511A0</td> <td>STAINLESS STEEL WASHER 4,2X12X1</td> <td>1</td> <td>PZ</td> </tr> <tr> <td>VM1794A0</td> <td>250X4.8 PA66 BLACK CLAMP</td> <td>2</td> <td>PZ</td> </tr> <tr> <td>VM2103A0</td> <td>CLAMP LOCK</td> <td>2</td> <td>PZ</td> </tr> </tbody> </table>	Code	Description	Qty	UOM	GN1085A2	141X24 HEATING ELEMENT GASKET	1	PZ	RS1225A1	4700W 230V D230 6 TURNS HEATING ELEMENT	1	PZ	SL1045A0	S53 BLACK SILICONE - 80ML CARTRIDGE	1	PZ	VI1032A0	SCREW M4X16 TCB+ INOX	1	PZ	VI1075A0	NUT M4 H=4 UNI5587 INOX	1	PZ	VI1220A1	4,2X12 TCB SELF-TAPPIN G SCREW	6	PZ	VI1511A0	STAINLESS STEEL WASHER 4,2X12X1	1	PZ	VM1794A0	250X4.8 PA66 BLACK CLAMP	2	PZ	VM2103A0	CLAMP LOCK	2	PZ
					Code	Description	Qty	UOM																																					
					GN1085A2	141X24 HEATING ELEMENT GASKET	1	PZ																																					
					RS1225A1	4700W 230V D230 6 TURNS HEATING ELEMENT	1	PZ																																					
					SL1045A0	S53 BLACK SILICONE - 80ML CARTRIDGE	1	PZ																																					
					VI1032A0	SCREW M4X16 TCB+ INOX	1	PZ																																					
					VI1075A0	NUT M4 H=4 UNI5587 INOX	1	PZ																																					
					VI1220A1	4,2X12 TCB SELF-TAPPIN G SCREW	6	PZ																																					
					VI1511A0	STAINLESS STEEL WASHER 4,2X12X1	1	PZ																																					
					VM1794A0	250X4.8 PA66 BLACK CLAMP	2	PZ																																					
VM2103A0	CLAMP LOCK	2	PZ																																										

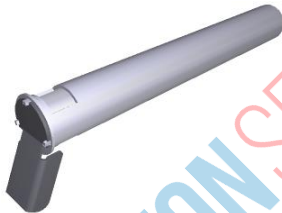
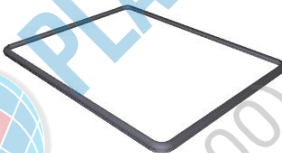



COMPONENT			SPARE PART														
Code	Description	Image	Code	Description	Components list												
0G1593A	XEBC FAN GUARD SPACER																
ASM1750A	General overview		ASM1750A0	General overview													
0G1586A	XEBC-06EU-E COMPLETE FAN GUARD																
VM2332A	WATER PIPE BUSHING		KVM2332A	WATER PIPE BUSHING KIT VM2332A0	<table border="1"> <thead> <tr> <th>Code</th> <th>Description</th> <th>Qty</th> <th>UOM</th> </tr> </thead> <tbody> <tr> <td>VM2332A0</td> <td>WATER PIPE BUSHING</td> <td>1</td> <td>PZ</td> </tr> </tbody> </table>	Code	Description	Qty	UOM	VM2332A0	WATER PIPE BUSHING	1	PZ				
Code	Description	Qty	UOM														
VM2332A0	WATER PIPE BUSHING	1	PZ														
VM2251A	STEAM WATER INLET UPPER DISTRIBUTOR		KVM2251A	STEAM WATER INLET DISTRIBUTORS KIT	<table border="1"> <thead> <tr> <th>Code</th> <th>Description</th> <th>Qty</th> <th>UOM</th> </tr> </thead> <tbody> <tr> <td>VM2251A0</td> <td>STEAM WATER INLET UPPER DISTRIBUTOR</td> <td>1</td> <td>PZ</td> </tr> <tr> <td>VM2252A0</td> <td>STEAM WATER INLET LOWER DISTRIBUTOR</td> <td>1</td> <td>PZ</td> </tr> </tbody> </table>	Code	Description	Qty	UOM	VM2251A0	STEAM WATER INLET UPPER DISTRIBUTOR	1	PZ	VM2252A0	STEAM WATER INLET LOWER DISTRIBUTOR	1	PZ
Code	Description	Qty	UOM														
VM2251A0	STEAM WATER INLET UPPER DISTRIBUTOR	1	PZ														
VM2252A0	STEAM WATER INLET LOWER DISTRIBUTOR	1	PZ														

COMPONENT			SPARE PART																						
Code	Description	Image	Code	Description	Components list																				
VM2252A	STEAM WATER INLET LOWER DISTRIBUTOR		KVM2251A	STEAM WATER INLET DISTRIBUTORS KIT	<table border="1"> <thead> <tr> <th>Code</th> <th>Description</th> <th>Qty</th> <th>UOM</th> </tr> </thead> <tbody> <tr> <td>VM2251A0</td> <td>STEAM WATER INLET UPPER DISTRIBUTOR</td> <td>1</td> <td>PZ</td> </tr> <tr> <td>VM2252A0</td> <td>STEAM WATER INLET LOWER DISTRIBUTOR</td> <td>1</td> <td>PZ</td> </tr> </tbody> </table>	Code	Description	Qty	UOM	VM2251A0	STEAM WATER INLET UPPER DISTRIBUTOR	1	PZ	VM2252A0	STEAM WATER INLET LOWER DISTRIBUTOR	1	PZ								
Code	Description	Qty	UOM																						
VM2251A0	STEAM WATER INLET UPPER DISTRIBUTOR	1	PZ																						
VM2252A0	STEAM WATER INLET LOWER DISTRIBUTOR	1	PZ																						
TB2980A	XEBC-06EU-E 2 WAYS WATER PIPE		TB2980A0	XEBC-06EU-E 2 WAYS WATER PIPE																					
GN1567A			KGN1567A	XEBC-06XX DOOR GASKET KIT	<table border="1"> <thead> <tr> <th>Code</th> <th>Description</th> <th>Qty</th> <th>UOM</th> </tr> </thead> <tbody> <tr> <td>GN1006A1</td> <td>DOOR GASKE</td> <td>2.480</td> <td>M</td> </tr> <tr> <td>GN1008A0</td> <td>DOOR SEAL INTERNAL CONNECTION</td> <td>0.030</td> <td>M</td> </tr> <tr> <td>SL1025A0</td> <td>CLEAR SILICON DOW CORNING 734</td> <td>0.012</td> <td>PZ</td> </tr> <tr> <td>VM2277A0</td> <td>DOOR SEAL KIT INTERNAL CONNECTION</td> <td>1</td> <td>PZ</td> </tr> </tbody> </table>	Code	Description	Qty	UOM	GN1006A1	DOOR GASKE	2.480	M	GN1008A0	DOOR SEAL INTERNAL CONNECTION	0.030	M	SL1025A0	CLEAR SILICON DOW CORNING 734	0.012	PZ	VM2277A0	DOOR SEAL KIT INTERNAL CONNECTION	1	PZ
Code	Description	Qty	UOM																						
GN1006A1	DOOR GASKE	2.480	M																						
GN1008A0	DOOR SEAL INTERNAL CONNECTION	0.030	M																						
SL1025A0	CLEAR SILICON DOW CORNING 734	0.012	PZ																						
VM2277A0	DOOR SEAL KIT INTERNAL CONNECTION	1	PZ																						
TB2902A	GAS OVENS CHAMBER CHIMNEY PIPE D50		TB2902A0	GAS OVENS CHAMBER CHIMNEY PIPE D50																					
GRL1405A	6X600X400 LEFT LATERAL SUPPORT		KGRL1405A	MIND.MAPS 6 600X400 LATERAL SUPPORTS KIT	<table border="1"> <thead> <tr> <th>Code</th> <th>Description</th> <th>Qty</th> <th>UOM</th> </tr> </thead> <tbody> <tr> <td>0H4215A0</td> <td>TRAYS GUIDE PROFILE L372.5 BT</td> <td>12</td> <td>PZ</td> </tr> <tr> <td>0H4420A0</td> <td>STAINLESS STEEL CORE TEMPERATUR</td> <td>1</td> <td>PZ</td> </tr> <tr> <td>0H7302A0</td> <td>0H7312+0H731 3 FLAT SUPPORTING PROFILE</td> <td>2</td> <td>PZ</td> </tr> </tbody> </table>	Code	Description	Qty	UOM	0H4215A0	TRAYS GUIDE PROFILE L372.5 BT	12	PZ	0H4420A0	STAINLESS STEEL CORE TEMPERATUR	1	PZ	0H7302A0	0H7312+0H731 3 FLAT SUPPORTING PROFILE	2	PZ				
Code	Description	Qty	UOM																						
0H4215A0	TRAYS GUIDE PROFILE L372.5 BT	12	PZ																						
0H4420A0	STAINLESS STEEL CORE TEMPERATUR	1	PZ																						
0H7302A0	0H7312+0H731 3 FLAT SUPPORTING PROFILE	2	PZ																						

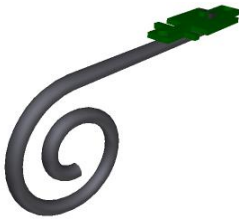

COMPONENT			SPARE PART																																		
Code	Description	Image	Code	Description	Components list																																
GRL1405A	6X600X400 LEFT LATERAL SUPPORT		KGRL1405A	MIND.MAPS 6 600X400 LATERAL SUPPORTS KIT	<table border="1"> <thead> <tr> <th>Code</th> <th>Description</th> <th>Qty</th> <th>UOM</th> </tr> </thead> <tbody> <tr> <td>0H7303A0</td> <td>0H7314+0H731 5 FLAT SUPPORTING PROFILE</td> <td>2</td> <td>PZ</td> </tr> <tr> <td>IP1508A1</td> <td>POLYSTYREN E U SHAPED PROFILE 2000X60X60</td> <td>1.200</td> <td>M</td> </tr> <tr> <td>VM1058A1</td> <td>HEAT SHRINK FILM H410</td> <td>1.500</td> <td>M</td> </tr> <tr> <td>VM1059A1</td> <td>HEAT SHRINK FILM H800</td> <td>1.500</td> <td>M</td> </tr> </tbody> </table>	Code	Description	Qty	UOM	0H7303A0	0H7314+0H731 5 FLAT SUPPORTING PROFILE	2	PZ	IP1508A1	POLYSTYREN E U SHAPED PROFILE 2000X60X60	1.200	M	VM1058A1	HEAT SHRINK FILM H410	1.500	M	VM1059A1	HEAT SHRINK FILM H800	1.500	M												
Code	Description	Qty	UOM																																		
0H7303A0	0H7314+0H731 5 FLAT SUPPORTING PROFILE	2	PZ																																		
IP1508A1	POLYSTYREN E U SHAPED PROFILE 2000X60X60	1.200	M																																		
VM1058A1	HEAT SHRINK FILM H410	1.500	M																																		
VM1059A1	HEAT SHRINK FILM H800	1.500	M																																		
GRL1406A	6X600X400 RIGHT LATERAL SUPPORT		KGRL1405A	MIND.MAPS 6 600X400 LATERAL SUPPORTS KIT	<table border="1"> <thead> <tr> <th>Code</th> <th>Description</th> <th>Qty</th> <th>UOM</th> </tr> </thead> <tbody> <tr> <td>0H4215A0</td> <td>TRAYS GUIDE PROFILE L372.5 BT</td> <td>12</td> <td>PZ</td> </tr> <tr> <td>0H4420A0</td> <td>STAINLESS STEEL CORE TEMPERATUR</td> <td>1</td> <td>PZ</td> </tr> <tr> <td>0H7302A0</td> <td>0H7312+0H731 3 FLAT SUPPORTING PROFILE</td> <td>2</td> <td>PZ</td> </tr> <tr> <td>0H7303A0</td> <td>0H7314+0H731 5 FLAT SUPPORTING PROFILE</td> <td>2</td> <td>PZ</td> </tr> <tr> <td>IP1508A1</td> <td>POLYSTYREN E U SHAPED PROFILE 2000X60X60</td> <td>1.200</td> <td>M</td> </tr> <tr> <td>VM1058A1</td> <td>HEAT SHRINK FILM H410</td> <td>1.500</td> <td>M</td> </tr> <tr> <td>VM1059A1</td> <td>HEAT SHRINK FILM H800</td> <td>1.500</td> <td>M</td> </tr> </tbody> </table>	Code	Description	Qty	UOM	0H4215A0	TRAYS GUIDE PROFILE L372.5 BT	12	PZ	0H4420A0	STAINLESS STEEL CORE TEMPERATUR	1	PZ	0H7302A0	0H7312+0H731 3 FLAT SUPPORTING PROFILE	2	PZ	0H7303A0	0H7314+0H731 5 FLAT SUPPORTING PROFILE	2	PZ	IP1508A1	POLYSTYREN E U SHAPED PROFILE 2000X60X60	1.200	M	VM1058A1	HEAT SHRINK FILM H410	1.500	M	VM1059A1	HEAT SHRINK FILM H800	1.500	M
Code	Description	Qty	UOM																																		
0H4215A0	TRAYS GUIDE PROFILE L372.5 BT	12	PZ																																		
0H4420A0	STAINLESS STEEL CORE TEMPERATUR	1	PZ																																		
0H7302A0	0H7312+0H731 3 FLAT SUPPORTING PROFILE	2	PZ																																		
0H7303A0	0H7314+0H731 5 FLAT SUPPORTING PROFILE	2	PZ																																		
IP1508A1	POLYSTYREN E U SHAPED PROFILE 2000X60X60	1.200	M																																		
VM1058A1	HEAT SHRINK FILM H410	1.500	M																																		
VM1059A1	HEAT SHRINK FILM H800	1.500	M																																		
0H2730A	ZINC PLATED MUFFLE SUPPORT BRACKET																																				

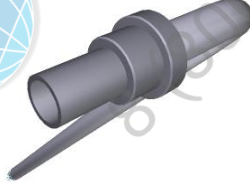
COMPONENT			SPARE PART																						
Code	Description	Image	Code	Description	Components list																				
PE1710B	MOTOR REVOLUTION AND DIRECTION SENSO		KPE1710B	MOTOR REVOLUTIONS SENSOR KIT	<table border="1"> <thead> <tr> <th>Code</th> <th>Description</th> <th>Qty</th> <th>UOM</th> </tr> </thead> <tbody> <tr> <td>PE1710B0</td> <td>MOTOR REVOLUTION AND DIRECTION SENSOR</td> <td>1</td> <td>PZ</td> </tr> <tr> <td>VE1550A0</td> <td>5X3 MM NEODYMIUM MAGNET</td> <td>1</td> <td>PZ</td> </tr> <tr> <td>VI1966A0</td> <td>M4X14 FLATHEAD SCREW</td> <td>1</td> <td>PZ</td> </tr> <tr> <td>VM1635A0</td> <td>MAGNET HOLDING DIS</td> <td>1</td> <td>PZ</td> </tr> </tbody> </table>	Code	Description	Qty	UOM	PE1710B0	MOTOR REVOLUTION AND DIRECTION SENSOR	1	PZ	VE1550A0	5X3 MM NEODYMIUM MAGNET	1	PZ	VI1966A0	M4X14 FLATHEAD SCREW	1	PZ	VM1635A0	MAGNET HOLDING DIS	1	PZ
Code	Description	Qty	UOM																						
PE1710B0	MOTOR REVOLUTION AND DIRECTION SENSOR	1	PZ																						
VE1550A0	5X3 MM NEODYMIUM MAGNET	1	PZ																						
VI1966A0	M4X14 FLATHEAD SCREW	1	PZ																						
VM1635A0	MAGNET HOLDING DIS	1	PZ																						
VE1550A	5X3 MM NEODYMIUM MAGNET		VE1550A0	5X3 MM NEODYMIUM MAGNET																					
TB2937B	XEBC EXTERNAL WATER PIPE D10+CONNECTION		TB2937B0	XEBC EXTERNAL WATER PIPE D10+CONNECTION																					

ASM1771A/0.D04 - External cover

FRONT

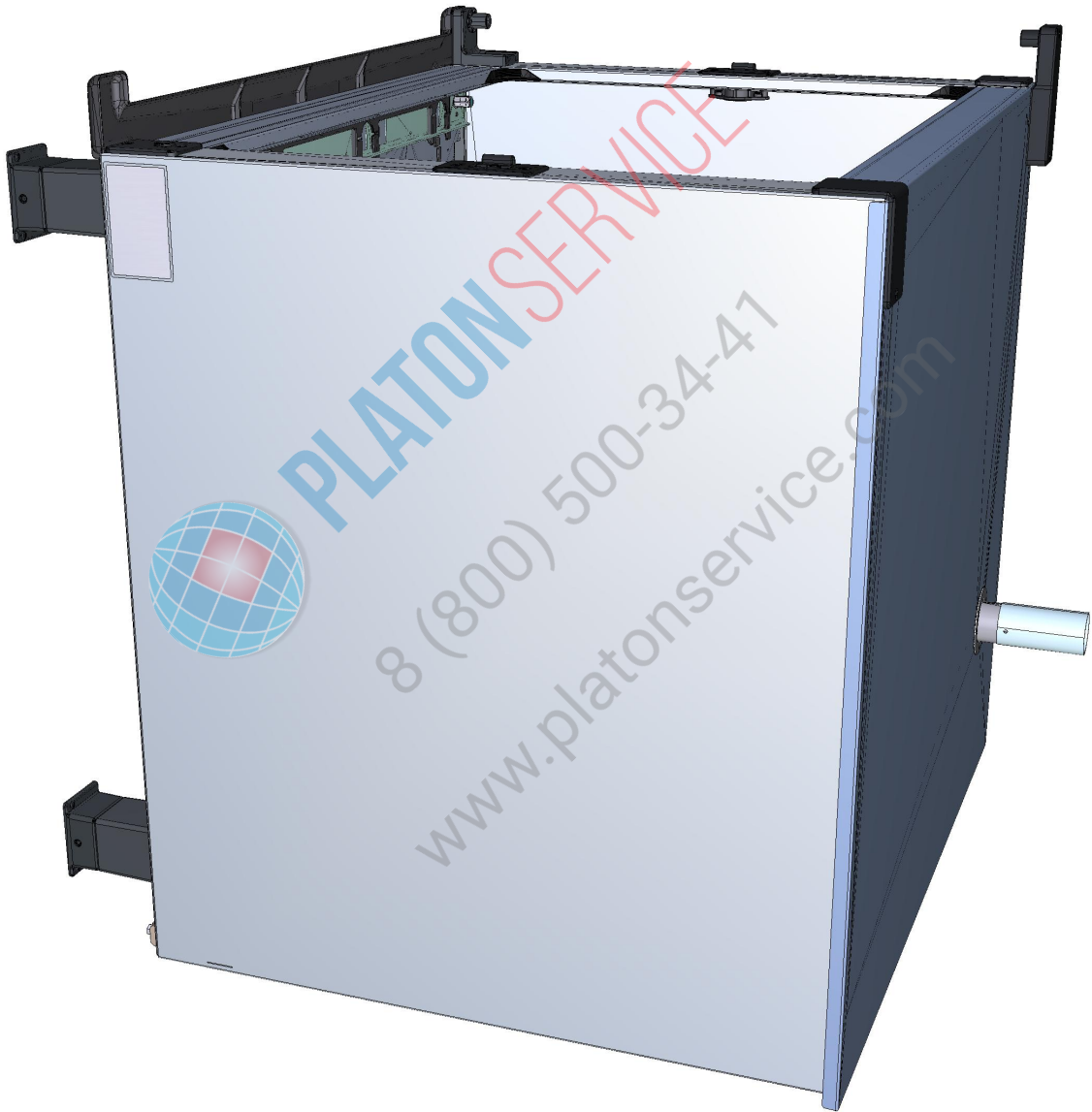





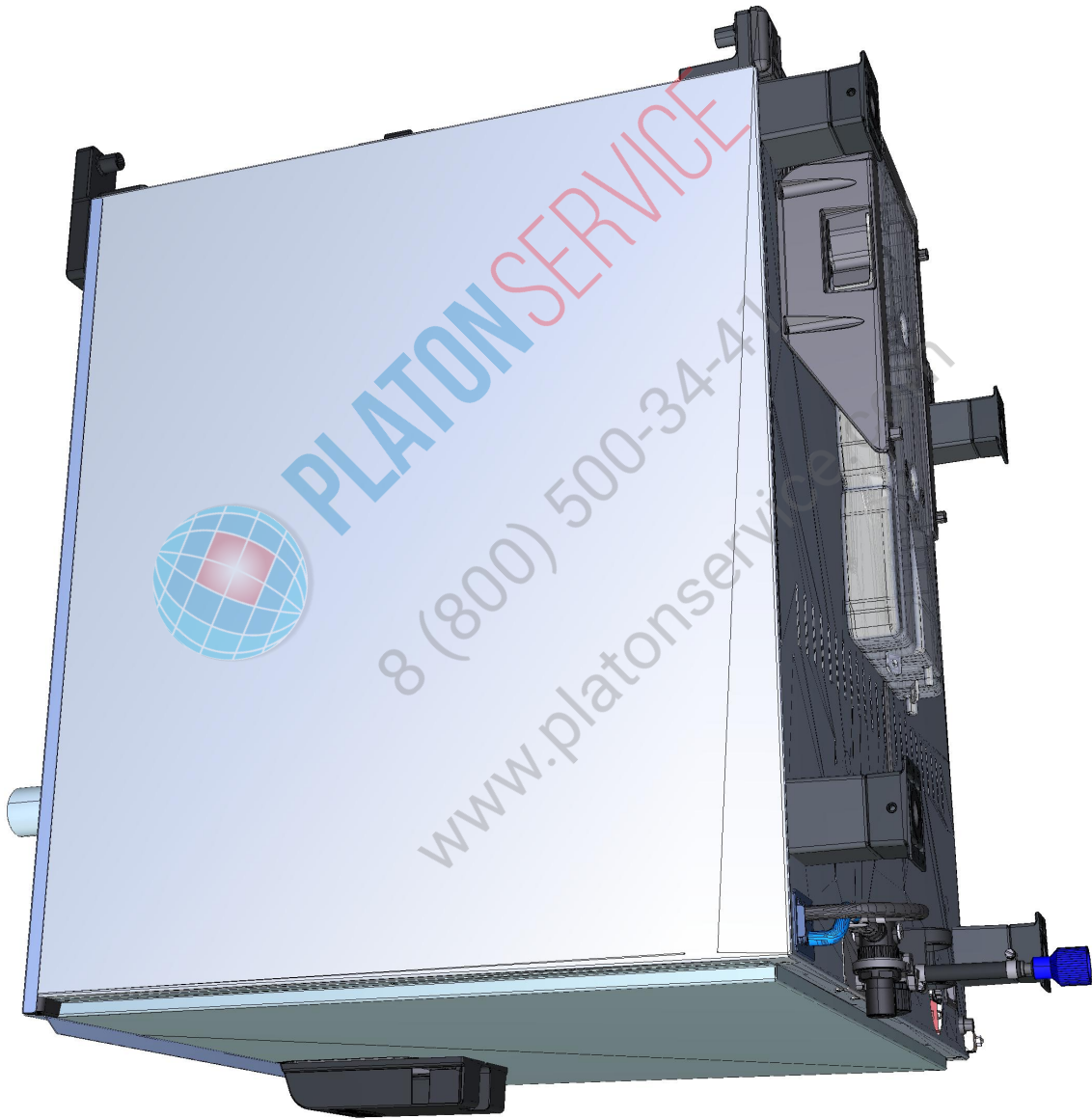

ASM1771A/0.D04 - External cover

REAR



COMPONENT			SPARE PART																										
Code	Description	Image	Code	Description	Components list																								
TR1136A	330°C 1 POLE SAFETY THERMOSTAT		KTR1136A	330°C SAFETY THERMOSTAT KIT	<table border="1"> <thead> <tr> <th>Code</th> <th>Description</th> <th>Qty</th> <th>UOM</th> </tr> </thead> <tbody> <tr> <td>0H7030A0</td> <td>THERMOSTAT BULB INLET COVER</td> <td>1</td> <td>PZ</td> </tr> <tr> <td>GN1531A0</td> <td>THERMOSTAT BULB INLET SEALING</td> <td>1</td> <td>PZ</td> </tr> <tr> <td>SL1045A0</td> <td>S53 BLACK SILICONE - 80ML CARTRIDGE</td> <td>1</td> <td>PZ</td> </tr> <tr> <td>TR1136A0</td> <td>330°C 1 POLE SAFETY THERMOSTAT</td> <td>1</td> <td>PZ</td> </tr> <tr> <td>VI1220A1</td> <td>4,2X12 TCB SELF-TAPPIN G SCREW</td> <td>3</td> <td>PZ</td> </tr> </tbody> </table>	Code	Description	Qty	UOM	0H7030A0	THERMOSTAT BULB INLET COVER	1	PZ	GN1531A0	THERMOSTAT BULB INLET SEALING	1	PZ	SL1045A0	S53 BLACK SILICONE - 80ML CARTRIDGE	1	PZ	TR1136A0	330°C 1 POLE SAFETY THERMOSTAT	1	PZ	VI1220A1	4,2X12 TCB SELF-TAPPIN G SCREW	3	PZ
Code	Description	Qty	UOM																										
0H7030A0	THERMOSTAT BULB INLET COVER	1	PZ																										
GN1531A0	THERMOSTAT BULB INLET SEALING	1	PZ																										
SL1045A0	S53 BLACK SILICONE - 80ML CARTRIDGE	1	PZ																										
TR1136A0	330°C 1 POLE SAFETY THERMOSTAT	1	PZ																										
VI1220A1	4,2X12 TCB SELF-TAPPIN G SCREW	3	PZ																										
VM1750A	BRASS COMB CLAM		KVM1750A	COMB TERMINAL BLOCK KIT	<table border="1"> <thead> <tr> <th>Code</th> <th>Description</th> <th>Qty</th> <th>UOM</th> </tr> </thead> <tbody> <tr> <td>VM1750A0</td> <td>BRASS COMB CLAMP</td> <td>1</td> <td>PZ</td> </tr> </tbody> </table>	Code	Description	Qty	UOM	VM1750A0	BRASS COMB CLAMP	1	PZ																
Code	Description	Qty	UOM																										
VM1750A0	BRASS COMB CLAMP	1	PZ																										
VM2074A	DRIP TRAY FIXING CLIP WITH SCREW		KVM1220A	CT/BT DRIP TRAY FIXING CLIPS 4PCS KIT	<table border="1"> <thead> <tr> <th>Code</th> <th>Description</th> <th>Qty</th> <th>UOM</th> </tr> </thead> <tbody> <tr> <td>VI1220A1</td> <td>4,2X12 TCB SELF-TAPPIN G SCREW</td> <td>4</td> <td>PZ</td> </tr> <tr> <td>VM1220A0</td> <td>CLIP TO FIX DRIP TRAY C.T</td> <td>4</td> <td>PZ</td> </tr> <tr> <td>VM2074A0</td> <td>DRIP TRAY FIXING CLIP WITH SCREW</td> <td>4</td> <td>PZ</td> </tr> </tbody> </table>	Code	Description	Qty	UOM	VI1220A1	4,2X12 TCB SELF-TAPPIN G SCREW	4	PZ	VM1220A0	CLIP TO FIX DRIP TRAY C.T	4	PZ	VM2074A0	DRIP TRAY FIXING CLIP WITH SCREW	4	PZ								
Code	Description	Qty	UOM																										
VI1220A1	4,2X12 TCB SELF-TAPPIN G SCREW	4	PZ																										
VM1220A0	CLIP TO FIX DRIP TRAY C.T	4	PZ																										
VM2074A0	DRIP TRAY FIXING CLIP WITH SCREW	4	PZ																										
VN1165A	230VAC 50/60HZ COOLING DOWN FA		KVN1165A	S.5E ADVANCE/MM 230V COOLING FAN KIT	<table border="1"> <thead> <tr> <th>Code</th> <th>Description</th> <th>Qty</th> <th>UOM</th> </tr> </thead> <tbody> <tr> <td>VI1099A0</td> <td>SELF-DRILLIN G SCREW 4.8X13 TCB+ Z</td> <td>4</td> <td>PZ</td> </tr> <tr> <td>VM1555A2</td> <td>CT BT COOLING FAN SUPPORT</td> <td>1</td> <td>PZ</td> </tr> <tr> <td>VN1165A0</td> <td>230VAC 50/60HZ COOLING DOWN FAN</td> <td>1</td> <td>PZ</td> </tr> </tbody> </table>	Code	Description	Qty	UOM	VI1099A0	SELF-DRILLIN G SCREW 4.8X13 TCB+ Z	4	PZ	VM1555A2	CT BT COOLING FAN SUPPORT	1	PZ	VN1165A0	230VAC 50/60HZ COOLING DOWN FAN	1	PZ								
Code	Description	Qty	UOM																										
VI1099A0	SELF-DRILLIN G SCREW 4.8X13 TCB+ Z	4	PZ																										
VM1555A2	CT BT COOLING FAN SUPPORT	1	PZ																										
VN1165A0	230VAC 50/60HZ COOLING DOWN FAN	1	PZ																										

COMPONENT			SPARE PART																														
Code	Description	Image	Code	Description	Components list																												
VM1556A	XBC-XVC COOLING FAN GUARD		KVM1556A	XBC-XVC COOLING FAN GUARD KIT	<table border="1"> <thead> <tr> <th>Code</th> <th>Description</th> <th>Qty</th> <th>UOM</th> </tr> </thead> <tbody> <tr> <td>VM1556A0</td> <td>XBC-XVC COOLING FAN GUARD</td> <td>1</td> <td>PZ</td> </tr> </tbody> </table>	Code	Description	Qty	UOM	VM1556A0	XBC-XVC COOLING FAN GUARD	1	PZ																				
Code	Description	Qty	UOM																														
VM1556A0	XBC-XVC COOLING FAN GUARD	1	PZ																														
VM1555A	CT BT COOLING FAN SUPPORT		KVN1165A  KVN1164A	S.5E ADVANCE/MM 230V COOLING FAN KIT  S.5/5E 12VDC COOLING DOWN FAN KIT	<table border="1"> <thead> <tr> <th>Code</th> <th>Description</th> <th>Qty</th> <th>UOM</th> </tr> </thead> <tbody> <tr> <td>VI1099A0</td> <td>SELF-DRILLIN G SCREW 4.8X13 TCB+ Z</td> <td>4</td> <td>PZ</td> </tr> <tr> <td>VM1555A2</td> <td>CT BT COOLING FAN SUPPORT</td> <td>1</td> <td>PZ</td> </tr> <tr> <td>VN1165A0</td> <td>230VAC 50/60HZ COOLING DOWN FAN</td> <td>1</td> <td>PZ</td> </tr> <tr> <td>VI1099A0</td> <td>SELF-DRILLIN G SCREW 4.8X13 TCB+ Z</td> <td>4</td> <td>PZ</td> </tr> <tr> <td>VM1555A2</td> <td>CT BT COOLING FAN SUPPORT</td> <td>1</td> <td>PZ</td> </tr> <tr> <td>VN1164A0</td> <td>12VDC COOLING DONW FAN</td> <td>1</td> <td>PZ</td> </tr> </tbody> </table>	Code	Description	Qty	UOM	VI1099A0	SELF-DRILLIN G SCREW 4.8X13 TCB+ Z	4	PZ	VM1555A2	CT BT COOLING FAN SUPPORT	1	PZ	VN1165A0	230VAC 50/60HZ COOLING DOWN FAN	1	PZ	VI1099A0	SELF-DRILLIN G SCREW 4.8X13 TCB+ Z	4	PZ	VM1555A2	CT BT COOLING FAN SUPPORT	1	PZ	VN1164A0	12VDC COOLING DONW FAN	1	PZ
Code	Description	Qty	UOM																														
VI1099A0	SELF-DRILLIN G SCREW 4.8X13 TCB+ Z	4	PZ																														
VM1555A2	CT BT COOLING FAN SUPPORT	1	PZ																														
VN1165A0	230VAC 50/60HZ COOLING DOWN FAN	1	PZ																														
VI1099A0	SELF-DRILLIN G SCREW 4.8X13 TCB+ Z	4	PZ																														
VM1555A2	CT BT COOLING FAN SUPPORT	1	PZ																														
VN1164A0	12VDC COOLING DONW FAN	1	PZ																														
VL1026A	BEND FOR DRAIN PIPE		KVL1026A	DRAIN PIPE BEND KI	<table border="1"> <thead> <tr> <th>Code</th> <th>Description</th> <th>Qty</th> <th>UOM</th> </tr> </thead> <tbody> <tr> <td>GN1400A0</td> <td>U-TRAP SEAL</td> <td>1</td> <td>PZ</td> </tr> <tr> <td>VL1026A0</td> <td>BEND FOR DRAIN PIPE</td> <td>1</td> <td>PZ</td> </tr> <tr> <td>VM2039A0</td> <td>DRAIN BEND FIXING RING</td> <td>1</td> <td>PZ</td> </tr> </tbody> </table>	Code	Description	Qty	UOM	GN1400A0	U-TRAP SEAL	1	PZ	VL1026A0	BEND FOR DRAIN PIPE	1	PZ	VM2039A0	DRAIN BEND FIXING RING	1	PZ												
Code	Description	Qty	UOM																														
GN1400A0	U-TRAP SEAL	1	PZ																														
VL1026A0	BEND FOR DRAIN PIPE	1	PZ																														
VM2039A0	DRAIN BEND FIXING RING	1	PZ																														
VM2039A	DRAIN BEND FIXING RING		KVL1026A	DRAIN PIPE BEND KI	<table border="1"> <thead> <tr> <th>Code</th> <th>Description</th> <th>Qty</th> <th>UOM</th> </tr> </thead> <tbody> <tr> <td>GN1400A0</td> <td>U-TRAP SEAL</td> <td>1</td> <td>PZ</td> </tr> <tr> <td>VL1026A0</td> <td>BEND FOR DRAIN PIPE</td> <td>1</td> <td>PZ</td> </tr> <tr> <td>VM2039A0</td> <td>DRAIN BEND FIXING RING</td> <td>1</td> <td>PZ</td> </tr> </tbody> </table>	Code	Description	Qty	UOM	GN1400A0	U-TRAP SEAL	1	PZ	VL1026A0	BEND FOR DRAIN PIPE	1	PZ	VM2039A0	DRAIN BEND FIXING RING	1	PZ												
Code	Description	Qty	UOM																														
GN1400A0	U-TRAP SEAL	1	PZ																														
VL1026A0	BEND FOR DRAIN PIPE	1	PZ																														
VM2039A0	DRAIN BEND FIXING RING	1	PZ																														

COMPONENT			SPARE PART																						
Code	Description	Image	Code	Description	Components list																				
VM2249A	COOKING CHAMBER FRONT CORNER		KVM2249A	CHAMBER FRONT PROFILE CORNER KIT	<table border="1"> <thead> <tr> <th>Code</th> <th>Description</th> <th>Qty</th> <th>UOM</th> </tr> </thead> <tbody> <tr> <td>VM2249A0</td> <td>COOKING CHAMBER FRONT CORNER</td> <td>1</td> <td>PZ</td> </tr> </tbody> </table>	Code	Description	Qty	UOM	VM2249A0	COOKING CHAMBER FRONT CORNER	1	PZ												
Code	Description	Qty	UOM																						
VM2249A0	COOKING CHAMBER FRONT CORNER	1	PZ																						
0H2561A	6 S. DOOR COUNTERBRACKET		0H2561A0	6 S. DOOR COUNTERBRACKET																					
VM1240A	NYLON SUPPORT CAP		KVM1240A	4 PCS COUNTER BRACKET SUPPORT CAP KIT	<table border="1"> <thead> <tr> <th>Code</th> <th>Description</th> <th>Qty</th> <th>UOM</th> </tr> </thead> <tbody> <tr> <td>VM1240A0</td> <td>NYLON SUPPORT CAP</td> <td>4</td> <td>PZ</td> </tr> </tbody> </table>	Code	Description	Qty	UOM	VM1240A0	NYLON SUPPORT CAP	4	PZ												
Code	Description	Qty	UOM																						
VM1240A0	NYLON SUPPORT CAP	4	PZ																						
VM2282A	MICROSWITCH SUPPORT COVER		KVM2282A	MICROSWITCH SUPPORT PLATE KI	<table border="1"> <thead> <tr> <th>Code</th> <th>Description</th> <th>Qty</th> <th>UOM</th> </tr> </thead> <tbody> <tr> <td>VM2282A0</td> <td>MICROSWITCH SUPPORT COVER</td> <td>1</td> <td>PZ</td> </tr> </tbody> </table>	Code	Description	Qty	UOM	VM2282A0	MICROSWITCH SUPPORT COVER	1	PZ												
Code	Description	Qty	UOM																						
VM2282A0	MICROSWITCH SUPPORT COVER	1	PZ																						
VE1020B	MAGNET DOOR MICROSWITCH		KVE1020B	MICROSWITCH KIT	<table border="1"> <thead> <tr> <th>Code</th> <th>Description</th> <th>Qty</th> <th>UOM</th> </tr> </thead> <tbody> <tr> <td>CE1030A0</td> <td>FEMALE FASTON COVER 6.3X0.8 0.5-1MMQ</td> <td>2</td> <td>PZ</td> </tr> <tr> <td>CE1660A0</td> <td>6.3X0.8 FEMALE FASTON COVER</td> <td>2</td> <td>PZ</td> </tr> <tr> <td>CE1730A0</td> <td>PVC CABLE NP 2 X AWG22 STYLE 2095</td> <td>0.150</td> <td>M</td> </tr> <tr> <td>CE1740A0</td> <td>MINIFIT MALE END FITTING</td> <td>2</td> <td>PZ</td> </tr> </tbody> </table>	Code	Description	Qty	UOM	CE1030A0	FEMALE FASTON COVER 6.3X0.8 0.5-1MMQ	2	PZ	CE1660A0	6.3X0.8 FEMALE FASTON COVER	2	PZ	CE1730A0	PVC CABLE NP 2 X AWG22 STYLE 2095	0.150	M	CE1740A0	MINIFIT MALE END FITTING	2	PZ
Code	Description	Qty	UOM																						
CE1030A0	FEMALE FASTON COVER 6.3X0.8 0.5-1MMQ	2	PZ																						
CE1660A0	6.3X0.8 FEMALE FASTON COVER	2	PZ																						
CE1730A0	PVC CABLE NP 2 X AWG22 STYLE 2095	0.150	M																						
CE1740A0	MINIFIT MALE END FITTING	2	PZ																						

COMPONENT			SPARE PART																										
Code	Description	Image	Code	Description	Components list																								
VE1020B	MAGNET DOOR MICROSWITCH		KVE1020B	MICROSWITCH KIT	<table border="1"> <thead> <tr> <th>Code</th> <th>Description</th> <th>Qty</th> <th>UOM</th> </tr> </thead> <tbody> <tr> <td>CE1745A0</td> <td>2 WAYS FEMALE MINIFIT CONNECTOR</td> <td>1</td> <td>PZ</td> </tr> <tr> <td>VE1020B0</td> <td>MAGNET DOOR MICROSWITC</td> <td>1</td> <td>PZ</td> </tr> <tr> <td>VE1030A1</td> <td>MAGNET FOR DOOR MICROSWITC H D=22,9MM</td> <td>1</td> <td>PZ</td> </tr> </tbody> </table>	Code	Description	Qty	UOM	CE1745A0	2 WAYS FEMALE MINIFIT CONNECTOR	1	PZ	VE1020B0	MAGNET DOOR MICROSWITC	1	PZ	VE1030A1	MAGNET FOR DOOR MICROSWITC H D=22,9MM	1	PZ								
					Code	Description	Qty	UOM																					
					CE1745A0	2 WAYS FEMALE MINIFIT CONNECTOR	1	PZ																					
VE1020B0	MAGNET DOOR MICROSWITC	1	PZ																										
VE1030A1	MAGNET FOR DOOR MICROSWITC H D=22,9MM	1	PZ																										
VM2035A	DRAIN PIPE SUPPORT		KVM2035A	DRAIN PIPE SUPPORT 2 PCS. KI	<table border="1"> <thead> <tr> <th>Code</th> <th>Description</th> <th>Qty</th> <th>UOM</th> </tr> </thead> <tbody> <tr> <td>VM2035A0</td> <td>DRAIN PIPE SUPPORT</td> <td>2</td> <td>PZ</td> </tr> </tbody> </table>	Code	Description	Qty	UOM	VM2035A0	DRAIN PIPE SUPPORT	2	PZ																
Code	Description	Qty	UOM																										
VM2035A0	DRAIN PIPE SUPPORT	2	PZ																										
VM1190A	CT BT RIGHT DOOR SPRING LATCH		KVM1190A	CHEFTOP/BAKERTO P DOOR RIGHT LATCH KIT	<table border="1"> <thead> <tr> <th>Code</th> <th>Description</th> <th>Qty</th> <th>UOM</th> </tr> </thead> <tbody> <tr> <td>VI0239A1</td> <td>SELF-TAPPIN G SCREW 4.2X25 TCB+ INOX</td> <td>2</td> <td>PZ</td> </tr> <tr> <td>VI1220A1</td> <td>4.2X12 TCB SELF-TAPPIN G SCREW</td> <td>2</td> <td>PZ</td> </tr> <tr> <td>VM1190A2</td> <td>CT BT RIGHT DOOR SPRING LATCH</td> <td>1</td> <td>PZ</td> </tr> <tr> <td>VM1192A1</td> <td>CT BT DOOR SPRING LATCH BACK COVER</td> <td>1</td> <td>PZ</td> </tr> <tr> <td>VM1460A0</td> <td>XBC/XVC RIGHT DOOR LATCH CAP</td> <td>1</td> <td>PZ</td> </tr> </tbody> </table>	Code	Description	Qty	UOM	VI0239A1	SELF-TAPPIN G SCREW 4.2X25 TCB+ INOX	2	PZ	VI1220A1	4.2X12 TCB SELF-TAPPIN G SCREW	2	PZ	VM1190A2	CT BT RIGHT DOOR SPRING LATCH	1	PZ	VM1192A1	CT BT DOOR SPRING LATCH BACK COVER	1	PZ	VM1460A0	XBC/XVC RIGHT DOOR LATCH CAP	1	PZ
Code	Description	Qty	UOM																										
VI0239A1	SELF-TAPPIN G SCREW 4.2X25 TCB+ INOX	2	PZ																										
VI1220A1	4.2X12 TCB SELF-TAPPIN G SCREW	2	PZ																										
VM1190A2	CT BT RIGHT DOOR SPRING LATCH	1	PZ																										
VM1192A1	CT BT DOOR SPRING LATCH BACK COVER	1	PZ																										
VM1460A0	XBC/XVC RIGHT DOOR LATCH CAP	1	PZ																										
VM1811A	WATER LEFT SEALING CAP		VM1811A0	WATER LEFT SEALING CAP																									

COMPONENT			SPARE PART														
Code	Description	Image	Code	Description	Components list												
VM2280A	DOOR LATCH COVE		KVM2280A	VM2280A HANDLE LATCH PLATE COVER KIT	<table border="1"> <thead> <tr> <th>Code</th> <th>Description</th> <th>Qty</th> <th>UOM</th> </tr> </thead> <tbody> <tr> <td>VM2280A0</td> <td>DOOR LATCH COVER</td> <td>1</td> <td>PZ</td> </tr> </tbody> </table>	Code	Description	Qty	UOM	VM2280A0	DOOR LATCH COVER	1	PZ				
Code	Description	Qty	UOM														
VM2280A0	DOOR LATCH COVER	1	PZ														
VM2281A	DOOR LATCH HOLES COVER		KVM2281A	HOLE PLATE COVER KIT	<table border="1"> <thead> <tr> <th>Code</th> <th>Description</th> <th>Qty</th> <th>UOM</th> </tr> </thead> <tbody> <tr> <td>VM2281A0</td> <td>DOOR LATCH HOLES COVER</td> <td>1</td> <td>PZ</td> </tr> </tbody> </table>	Code	Description	Qty	UOM	VM2281A0	DOOR LATCH HOLES COVER	1	PZ				
Code	Description	Qty	UOM														
VM2281A0	DOOR LATCH HOLES COVER	1	PZ														
VM2311A	SCREWS COVER		KVM2311A	SCREWS COVER PLATE KIT	<table border="1"> <thead> <tr> <th>Code</th> <th>Description</th> <th>Qty</th> <th>UOM</th> </tr> </thead> <tbody> <tr> <td>VM2311A0</td> <td>SCREWS COVER</td> <td>1</td> <td>PZ</td> </tr> </tbody> </table>	Code	Description	Qty	UOM	VM2311A0	SCREWS COVER	1	PZ				
Code	Description	Qty	UOM														
VM2311A0	SCREWS COVER	1	PZ														
GN1558A	EXHAUST SEAL		K0H7291A	GASKET AND SEALING DISC CHIMNEY KIT	<table border="1"> <thead> <tr> <th>Code</th> <th>Description</th> <th>Qty</th> <th>UOM</th> </tr> </thead> <tbody> <tr> <td>0H7291A0</td> <td>CHIMNEY HOLDING DIS</td> <td>1</td> <td>PZ</td> </tr> <tr> <td>GN1558A0</td> <td>EXHAUST SEA</td> <td>1</td> <td>PZ</td> </tr> </tbody> </table>	Code	Description	Qty	UOM	0H7291A0	CHIMNEY HOLDING DIS	1	PZ	GN1558A0	EXHAUST SEA	1	PZ
Code	Description	Qty	UOM														
0H7291A0	CHIMNEY HOLDING DIS	1	PZ														
GN1558A0	EXHAUST SEA	1	PZ														
0H7291A	CHIMNEY HOLDING DISC		K0H7291A	GASKET AND SEALING DISC CHIMNEY KIT	<table border="1"> <thead> <tr> <th>Code</th> <th>Description</th> <th>Qty</th> <th>UOM</th> </tr> </thead> <tbody> <tr> <td>0H7291A0</td> <td>CHIMNEY HOLDING DIS</td> <td>1</td> <td>PZ</td> </tr> <tr> <td>GN1558A0</td> <td>EXHAUST SEA</td> <td>1</td> <td>PZ</td> </tr> </tbody> </table>	Code	Description	Qty	UOM	0H7291A0	CHIMNEY HOLDING DIS	1	PZ	GN1558A0	EXHAUST SEA	1	PZ
Code	Description	Qty	UOM														
0H7291A0	CHIMNEY HOLDING DIS	1	PZ														
GN1558A0	EXHAUST SEA	1	PZ														



COMPONENT			SPARE PART																										
Code	Description	Image	Code	Description	Components list																								
VM1118A	DET&RINSE PLUS TANK LEFT GUIDE		KVM1118A	DET&RINSE TANK LEFT GUIDE KIT FOR MM	<table border="1"> <thead> <tr> <th>Code</th> <th>Description</th> <th>Qty</th> <th>UOM</th> </tr> </thead> <tbody> <tr> <td>VI1220A1</td> <td>4,2X12 TCB SELF-TAPPIN G SCREW</td> <td>2</td> <td>PZ</td> </tr> <tr> <td>VM1118A0</td> <td>DET&amp;RINSE PLUS TANK LEFT GUIDE</td> <td>1</td> <td>PZ</td> </tr> </tbody> </table>	Code	Description	Qty	UOM	VI1220A1	4,2X12 TCB SELF-TAPPIN G SCREW	2	PZ	VM1118A0	DET&RINSE PLUS TANK LEFT GUIDE	1	PZ												
Code	Description	Qty	UOM																										
VI1220A1	4,2X12 TCB SELF-TAPPIN G SCREW	2	PZ																										
VM1118A0	DET&RINSE PLUS TANK LEFT GUIDE	1	PZ																										
VM1119A	DET&RINSE PLUS TANK RIGHT GUIDE		KVM1119A	DET&RINSE TANK RIGHT GUIDE KIT FOR MM	<table border="1"> <thead> <tr> <th>Code</th> <th>Description</th> <th>Qty</th> <th>UOM</th> </tr> </thead> <tbody> <tr> <td>VI1220A1</td> <td>4,2X12 TCB SELF-TAPPIN G SCREW</td> <td>2</td> <td>PZ</td> </tr> <tr> <td>VM1119A0</td> <td>DET&amp;RINSE PLUS TANK RIGHT GUIDE</td> <td>1</td> <td>PZ</td> </tr> </tbody> </table>	Code	Description	Qty	UOM	VI1220A1	4,2X12 TCB SELF-TAPPIN G SCREW	2	PZ	VM1119A0	DET&RINSE PLUS TANK RIGHT GUIDE	1	PZ												
Code	Description	Qty	UOM																										
VI1220A1	4,2X12 TCB SELF-TAPPIN G SCREW	2	PZ																										
VM1119A0	DET&RINSE PLUS TANK RIGHT GUIDE	1	PZ																										
SB1015A	4L DETERGENT TAN		KSB1015A	4L DETERGENT TANK KIT	<table border="1"> <thead> <tr> <th>Code</th> <th>Description</th> <th>Qty</th> <th>UOM</th> </tr> </thead> <tbody> <tr> <td>IP1385A1</td> <td>CORNER POLYSTYREN E PACKING 110X80X2000</td> <td>1.200</td> <td>M</td> </tr> <tr> <td>IP1410A0</td> <td>POLYSTYREN E PACKING TO PROTECT</td> <td>2</td> <td>PZ</td> </tr> <tr> <td>SB1015A1</td> <td>4L DETERGENT TANK</td> <td>1</td> <td>PZ</td> </tr> <tr> <td>SB1015A2</td> <td>4L DETERGENT TANK</td> <td>1</td> <td>PZ</td> </tr> <tr> <td>VM1059A1</td> <td>HEAT SHRINK FILM H800</td> <td>1.200</td> <td>M</td> </tr> </tbody> </table>	Code	Description	Qty	UOM	IP1385A1	CORNER POLYSTYREN E PACKING 110X80X2000	1.200	M	IP1410A0	POLYSTYREN E PACKING TO PROTECT	2	PZ	SB1015A1	4L DETERGENT TANK	1	PZ	SB1015A2	4L DETERGENT TANK	1	PZ	VM1059A1	HEAT SHRINK FILM H800	1.200	M
Code	Description	Qty	UOM																										
IP1385A1	CORNER POLYSTYREN E PACKING 110X80X2000	1.200	M																										
IP1410A0	POLYSTYREN E PACKING TO PROTECT	2	PZ																										
SB1015A1	4L DETERGENT TANK	1	PZ																										
SB1015A2	4L DETERGENT TANK	1	PZ																										
VM1059A1	HEAT SHRINK FILM H800	1.200	M																										
VM2310A	UPPER DOOR BRACKET HOLES COVER		KVM2310A	UPPER BRACKET HOLE COVER KIT	<table border="1"> <thead> <tr> <th>Code</th> <th>Description</th> <th>Qty</th> <th>UOM</th> </tr> </thead> <tbody> <tr> <td>VM2310A0</td> <td>UPPER DOOR BRACKET HOLES COVER</td> <td>1</td> <td>PZ</td> </tr> </tbody> </table>	Code	Description	Qty	UOM	VM2310A0	UPPER DOOR BRACKET HOLES COVER	1	PZ																
Code	Description	Qty	UOM																										
VM2310A0	UPPER DOOR BRACKET HOLES COVER	1	PZ																										



COMPONENT			SPARE PART																										
Code	Description	Image	Code	Description	Components list																								
VM1192A	CT BT DOOR SPRING LATCH BACK COVER		KVM1191A	CHEFTOP/BAKERTO P DOOR LEFT LATCH KIT	<table border="1"> <thead> <tr> <th>Code</th> <th>Description</th> <th>Qty</th> <th>UOM</th> </tr> </thead> <tbody> <tr> <td>VI0239A1</td> <td>SELF-TAPPIN G SCREW 4.2X25 TCB+ INOX</td> <td>2</td> <td>PZ</td> </tr> <tr> <td>VI1220A1</td> <td>4,2X12 TCB SELF-TAPPIN G SCREW</td> <td>2</td> <td>PZ</td> </tr> <tr> <td>VM1191A2</td> <td>CT BT LEFT DOOR SPRING LATCH</td> <td>1</td> <td>PZ</td> </tr> <tr> <td>VM1192A1</td> <td>CT BT DOOR SPRING LATCH BACK COVER</td> <td>1</td> <td>PZ</td> </tr> <tr> <td>VM1460A0</td> <td>XBC/XVC RIGHT DOOR LATCH CAP</td> <td>1</td> <td>PZ</td> </tr> </tbody> </table>	Code	Description	Qty	UOM	VI0239A1	SELF-TAPPIN G SCREW 4.2X25 TCB+ INOX	2	PZ	VI1220A1	4,2X12 TCB SELF-TAPPIN G SCREW	2	PZ	VM1191A2	CT BT LEFT DOOR SPRING LATCH	1	PZ	VM1192A1	CT BT DOOR SPRING LATCH BACK COVER	1	PZ	VM1460A0	XBC/XVC RIGHT DOOR LATCH CAP	1	PZ
			Code	Description	Qty	UOM																							
VI0239A1	SELF-TAPPIN G SCREW 4.2X25 TCB+ INOX	2	PZ																										
VI1220A1	4,2X12 TCB SELF-TAPPIN G SCREW	2	PZ																										
VM1191A2	CT BT LEFT DOOR SPRING LATCH	1	PZ																										
VM1192A1	CT BT DOOR SPRING LATCH BACK COVER	1	PZ																										
VM1460A0	XBC/XVC RIGHT DOOR LATCH CAP	1	PZ																										
KVM1190A	CHEFTOP/BAKERTO P DOOR RIGHT LATCH KIT	<table border="1"> <thead> <tr> <th>Code</th> <th>Description</th> <th>Qty</th> <th>UOM</th> </tr> </thead> <tbody> <tr> <td>VI0239A1</td> <td>SELF-TAPPIN G SCREW 4.2X25 TCB+ INOX</td> <td>2</td> <td>PZ</td> </tr> <tr> <td>VI1220A1</td> <td>4,2X12 TCB SELF-TAPPIN G SCREW</td> <td>2</td> <td>PZ</td> </tr> <tr> <td>VM1190A2</td> <td>CT BT RIGHT DOOR SPRING LATCH</td> <td>1</td> <td>PZ</td> </tr> <tr> <td>VM1192A1</td> <td>CT BT DOOR SPRING LATCH BACK COVER</td> <td>1</td> <td>PZ</td> </tr> <tr> <td>VM1460A0</td> <td>XBC/XVC RIGHT DOOR LATCH CAP</td> <td>1</td> <td>PZ</td> </tr> </tbody> </table>	Code	Description	Qty	UOM	VI0239A1	SELF-TAPPIN G SCREW 4.2X25 TCB+ INOX	2	PZ	VI1220A1	4,2X12 TCB SELF-TAPPIN G SCREW	2	PZ	VM1190A2	CT BT RIGHT DOOR SPRING LATCH	1	PZ	VM1192A1	CT BT DOOR SPRING LATCH BACK COVER	1	PZ	VM1460A0	XBC/XVC RIGHT DOOR LATCH CAP	1	PZ			
Code	Description	Qty	UOM																										
VI0239A1	SELF-TAPPIN G SCREW 4.2X25 TCB+ INOX	2	PZ																										
VI1220A1	4,2X12 TCB SELF-TAPPIN G SCREW	2	PZ																										
VM1190A2	CT BT RIGHT DOOR SPRING LATCH	1	PZ																										
VM1192A1	CT BT DOOR SPRING LATCH BACK COVER	1	PZ																										
VM1460A0	XBC/XVC RIGHT DOOR LATCH CAP	1	PZ																										
VM1191A	CT BT LEFT DOOR SPRING LATCH		KVM1191A	CHEFTOP/BAKERTO P DOOR LEFT LATCH KIT	<table border="1"> <thead> <tr> <th>Code</th> <th>Description</th> <th>Qty</th> <th>UOM</th> </tr> </thead> <tbody> <tr> <td>VI0239A1</td> <td>SELF-TAPPIN G SCREW 4.2X25 TCB+ INOX</td> <td>2</td> <td>PZ</td> </tr> <tr> <td>VI1220A1</td> <td>4,2X12 TCB SELF-TAPPIN G SCREW</td> <td>2</td> <td>PZ</td> </tr> <tr> <td>VM1191A2</td> <td>CT BT LEFT DOOR SPRING LATCH</td> <td>1</td> <td>PZ</td> </tr> <tr> <td>VM1192A1</td> <td>CT BT DOOR SPRING LATCH BACK COVER</td> <td>1</td> <td>PZ</td> </tr> <tr> <td>VM1460A0</td> <td>XBC/XVC RIGHT DOOR LATCH CAP</td> <td>1</td> <td>PZ</td> </tr> </tbody> </table>	Code	Description	Qty	UOM	VI0239A1	SELF-TAPPIN G SCREW 4.2X25 TCB+ INOX	2	PZ	VI1220A1	4,2X12 TCB SELF-TAPPIN G SCREW	2	PZ	VM1191A2	CT BT LEFT DOOR SPRING LATCH	1	PZ	VM1192A1	CT BT DOOR SPRING LATCH BACK COVER	1	PZ	VM1460A0	XBC/XVC RIGHT DOOR LATCH CAP	1	PZ
Code	Description	Qty	UOM																										
VI0239A1	SELF-TAPPIN G SCREW 4.2X25 TCB+ INOX	2	PZ																										
VI1220A1	4,2X12 TCB SELF-TAPPIN G SCREW	2	PZ																										
VM1191A2	CT BT LEFT DOOR SPRING LATCH	1	PZ																										
VM1192A1	CT BT DOOR SPRING LATCH BACK COVER	1	PZ																										
VM1460A0	XBC/XVC RIGHT DOOR LATCH CAP	1	PZ																										



COMPONENT			SPARE PART																										
Code	Description	Image	Code	Description	Components list																								
VM1992A	E SERIES BAKERTOP DRIP TRAY		KVM1992A	E SERIES BAKERTOP DRIP TRAY	<table border="1"> <thead> <tr> <th>Code</th> <th>Description</th> <th>Qty</th> <th>UOM</th> </tr> </thead> <tbody> <tr> <td>VM1220A0</td> <td>CLIP TO FIX DRIP TRAY C.T</td> <td>4</td> <td>PZ</td> </tr> <tr> <td>VM1794A0</td> <td>250X4.8 PA66 BLACK CLAMP</td> <td>2</td> <td>PZ</td> </tr> <tr> <td>VM1992A0</td> <td>E SERIES BAKERTOP DRIP TRAY</td> <td>1</td> <td>PZ</td> </tr> <tr> <td>VM2074A0</td> <td>DRIP TRAY FIXING CLIP WITH SCREW</td> <td>4</td> <td>PZ</td> </tr> <tr> <td>VM2103A0</td> <td>CLAMP LOCK</td> <td>2</td> <td>PZ</td> </tr> </tbody> </table>	Code	Description	Qty	UOM	VM1220A0	CLIP TO FIX DRIP TRAY C.T	4	PZ	VM1794A0	250X4.8 PA66 BLACK CLAMP	2	PZ	VM1992A0	E SERIES BAKERTOP DRIP TRAY	1	PZ	VM2074A0	DRIP TRAY FIXING CLIP WITH SCREW	4	PZ	VM2103A0	CLAMP LOCK	2	PZ
Code	Description	Qty	UOM																										
VM1220A0	CLIP TO FIX DRIP TRAY C.T	4	PZ																										
VM1794A0	250X4.8 PA66 BLACK CLAMP	2	PZ																										
VM1992A0	E SERIES BAKERTOP DRIP TRAY	1	PZ																										
VM2074A0	DRIP TRAY FIXING CLIP WITH SCREW	4	PZ																										
VM2103A0	CLAMP LOCK	2	PZ																										
0F1504A	XEBC-06EU-E BACK		0F1504A0	XEBC-06EU-E BACK																									
0H2561A	6 S. DOOR COUNTERBRACKET		0H2561A0	6 S. DOOR COUNTERBRACKET																									
VI1995A	M5X25 ST.STEEL SCREW		VI1995A0	M5X25 ST.STEEL SCREW																									
VM2352A	LOWER DOOR BRACKET SCREW LEFT COVER		VM2352A0	LOWER DOOR BRACKET SCREW LEFT COVER																									



COMPONENT			SPARE PART																														
Code	Description	Image	Code	Description	Components list																												
VM2353A	LOWER DOOR BRACKET SCREW RIGHT COVER		VM2353A0	LOWER DOOR BRACKET SCREW RIGHT COVER																													
VM1240A	NYLON SUPPORT CAP		KVM1240A	4 PCS COUNTER BRACKET SUPPORT CAP KIT	<table border="1"> <thead> <tr> <th>Code</th> <th>Description</th> <th>Qty</th> <th>UOM</th> </tr> </thead> <tbody> <tr> <td>VM1240A0</td> <td>NYLON SUPPORT CAP</td> <td>4</td> <td>PZ</td> </tr> </tbody> </table>	Code	Description	Qty	UOM	VM1240A0	NYLON SUPPORT CAP	4	PZ																				
Code	Description	Qty	UOM																														
VM1240A0	NYLON SUPPORT CAP	4	PZ																														
VM2273A	6 S. LEFT LOWER DOOR BRACKET		KVM2273A	MIND.MAPS DOOR LOWER LEFT BRACKET KIT	<table border="1"> <thead> <tr> <th>Code</th> <th>Description</th> <th>Qty</th> <th>UOM</th> </tr> </thead> <tbody> <tr> <td>0H7330A0</td> <td>DOOR LOWER BRACKET WASHER</td> <td>2</td> <td>PZ</td> </tr> <tr> <td>V11995A0</td> <td>M5X25 ST.STEEL SCREW</td> <td>4</td> <td>PZ</td> </tr> <tr> <td>VM2273A0</td> <td>6 S. LEFT LOWER DOOR BRACKET</td> <td>1</td> <td>PZ</td> </tr> <tr> <td>VM2273A1</td> <td>MM LEFT INFERIOR BRACKET DOOR</td> <td>1</td> <td>PZ</td> </tr> <tr> <td>VM2352A0</td> <td>LOWER DOOR BRACKET SCREW LEFT COVER</td> <td>2</td> <td>PZ</td> </tr> <tr> <td>VM2353A0</td> <td>LOWER DOOR BRACKET SCREW RIGHT COVER</td> <td>1</td> <td>PZ</td> </tr> </tbody> </table>	Code	Description	Qty	UOM	0H7330A0	DOOR LOWER BRACKET WASHER	2	PZ	V11995A0	M5X25 ST.STEEL SCREW	4	PZ	VM2273A0	6 S. LEFT LOWER DOOR BRACKET	1	PZ	VM2273A1	MM LEFT INFERIOR BRACKET DOOR	1	PZ	VM2352A0	LOWER DOOR BRACKET SCREW LEFT COVER	2	PZ	VM2353A0	LOWER DOOR BRACKET SCREW RIGHT COVER	1	PZ
Code	Description	Qty	UOM																														
0H7330A0	DOOR LOWER BRACKET WASHER	2	PZ																														
V11995A0	M5X25 ST.STEEL SCREW	4	PZ																														
VM2273A0	6 S. LEFT LOWER DOOR BRACKET	1	PZ																														
VM2273A1	MM LEFT INFERIOR BRACKET DOOR	1	PZ																														
VM2352A0	LOWER DOOR BRACKET SCREW LEFT COVER	2	PZ																														
VM2353A0	LOWER DOOR BRACKET SCREW RIGHT COVER	1	PZ																														
0H7675A																																	





COMPONENT			SPARE PART																										
Code	Description	Image	Code	Description	Components list																								
0H2561A	6 S. DOOR COUNTERBRACKET		0H2561A0	6 S. DOOR COUNTERBRACKET																									
VI1995A	M5X25 ST.STEEL SCREW		VI1995A0	M5X25 ST.STEEL SCREW																									
VM1240A	NYLON SUPPORT CAP		KVM1240A	4 PCS COUNTER BRACKET SUPPORT CAP KIT	<table border="1"> <thead> <tr> <th>Code</th> <th>Description</th> <th>Qty</th> <th>UOM</th> </tr> </thead> <tbody> <tr> <td>VM1240A0</td> <td>NYLON SUPPORT CAP</td> <td>4</td> <td>PZ</td> </tr> </tbody> </table>	Code	Description	Qty	UOM	VM1240A0	NYLON SUPPORT CAP	4	PZ																
Code	Description	Qty	UOM																										
VM1240A0	NYLON SUPPORT CAP	4	PZ																										
VM2298A	DOOR BRACKET UPPER COVER		KVM2298A	MIND.MAPS DOOR UPPER BRACKET COVER KIT	<table border="1"> <thead> <tr> <th>Code</th> <th>Description</th> <th>Qty</th> <th>UOM</th> </tr> </thead> <tbody> <tr> <td>VI1220A0</td> <td>SELF-TAPPIN G SCREW 4.2X12 TCB</td> <td>2</td> <td>PZ</td> </tr> <tr> <td>VM2298A0</td> <td>DOOR BRACKET UPPER COVER</td> <td>1</td> <td>PZ</td> </tr> </tbody> </table>	Code	Description	Qty	UOM	VI1220A0	SELF-TAPPIN G SCREW 4.2X12 TCB	2	PZ	VM2298A0	DOOR BRACKET UPPER COVER	1	PZ												
Code	Description	Qty	UOM																										
VI1220A0	SELF-TAPPIN G SCREW 4.2X12 TCB	2	PZ																										
VM2298A0	DOOR BRACKET UPPER COVER	1	PZ																										
VM2271A	LEFT DOOR UPPER BRACKET		KVM2271A	MIND.MAPS UPPER LEFT DOOR BRACKET KIT	<table border="1"> <thead> <tr> <th>Code</th> <th>Description</th> <th>Qty</th> <th>UOM</th> </tr> </thead> <tbody> <tr> <td>VI1220A1</td> <td>4.2X12 TCB SELF-TAPPIN G SCREW</td> <td>2</td> <td>PZ</td> </tr> <tr> <td>VI1995A0</td> <td>M5X25 ST.STEEL SCREW</td> <td>4</td> <td>PZ</td> </tr> <tr> <td>VI1997A0</td> <td>5X10X1 FLAT WASHER</td> <td>4</td> <td>PZ</td> </tr> <tr> <td>VM2271A0</td> <td>LEFT DOOR UPPER BRACKET</td> <td>1</td> <td>PZ</td> </tr> <tr> <td>VM2298A0</td> <td>DOOR BRACKET UPPER COVER</td> <td>1</td> <td>PZ</td> </tr> </tbody> </table>	Code	Description	Qty	UOM	VI1220A1	4.2X12 TCB SELF-TAPPIN G SCREW	2	PZ	VI1995A0	M5X25 ST.STEEL SCREW	4	PZ	VI1997A0	5X10X1 FLAT WASHER	4	PZ	VM2271A0	LEFT DOOR UPPER BRACKET	1	PZ	VM2298A0	DOOR BRACKET UPPER COVER	1	PZ
Code	Description	Qty	UOM																										
VI1220A1	4.2X12 TCB SELF-TAPPIN G SCREW	2	PZ																										
VI1995A0	M5X25 ST.STEEL SCREW	4	PZ																										
VI1997A0	5X10X1 FLAT WASHER	4	PZ																										
VM2271A0	LEFT DOOR UPPER BRACKET	1	PZ																										
VM2298A0	DOOR BRACKET UPPER COVER	1	PZ																										





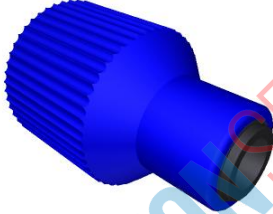

COMPONENT			SPARE PART																		
Code	Description	Image	Code	Description	Components list																
0H7675A																					
PD1074A	H=100 SQUARE FOO		KPD1074A	MIND.MAPS H100 FOOT KIT	<table border="1"> <thead> <tr> <th>Code</th> <th>Description</th> <th>Qty</th> <th>UOM</th> </tr> </thead> <tbody> <tr> <td>PD1074A0</td> <td>H=100 SQUARE FOO</td> <td>1</td> <td>PZ</td> </tr> <tr> <td>PD1075A0</td> <td>FOOT LOCKING BRACKET</td> <td>1</td> <td>PZ</td> </tr> <tr> <td>VI1220A1</td> <td>4,2X12 TCB SELF-TAPPIN G SCREW</td> <td>5</td> <td>PZ</td> </tr> </tbody> </table>	Code	Description	Qty	UOM	PD1074A0	H=100 SQUARE FOO	1	PZ	PD1075A0	FOOT LOCKING BRACKET	1	PZ	VI1220A1	4,2X12 TCB SELF-TAPPIN G SCREW	5	PZ
Code	Description	Qty	UOM																		
PD1074A0	H=100 SQUARE FOO	1	PZ																		
PD1075A0	FOOT LOCKING BRACKET	1	PZ																		
VI1220A1	4,2X12 TCB SELF-TAPPIN G SCREW	5	PZ																		
PD1075A	FOOT LOCKING BRACKET		KPD1075A	OVEN FOOT STOPPING BRACKET KIT	<table border="1"> <thead> <tr> <th>Code</th> <th>Description</th> <th>Qty</th> <th>UOM</th> </tr> </thead> <tbody> <tr> <td>PD1075A0</td> <td>FOOT LOCKING BRACKET</td> <td>4</td> <td>PZ</td> </tr> <tr> <td>VI1950A0</td> <td>ST. STEEL 4,2X13 TCB SELF-DRILLIN G SCREW</td> <td>8</td> <td>PZ</td> </tr> </tbody> </table>	Code	Description	Qty	UOM	PD1075A0	FOOT LOCKING BRACKET	4	PZ	VI1950A0	ST. STEEL 4,2X13 TCB SELF-DRILLIN G SCREW	8	PZ				
Code	Description	Qty	UOM																		
PD1075A0	FOOT LOCKING BRACKET	4	PZ																		
VI1950A0	ST. STEEL 4,2X13 TCB SELF-DRILLIN G SCREW	8	PZ																		
0H2561A	6 S. DOOR COUNTERBRACKET		0H2561A0	6 S. DOOR COUNTERBRACKET																	
VM1240A	NYLON SUPPORT CAP		KVM1240A	4 PCS COUNTER BRACKET SUPPORT CAP KIT	<table border="1"> <thead> <tr> <th>Code</th> <th>Description</th> <th>Qty</th> <th>UOM</th> </tr> </thead> <tbody> <tr> <td>VM1240A0</td> <td>NYLON SUPPORT CAP</td> <td>4</td> <td>PZ</td> </tr> </tbody> </table>	Code	Description	Qty	UOM	VM1240A0	NYLON SUPPORT CAP	4	PZ								
Code	Description	Qty	UOM																		
VM1240A0	NYLON SUPPORT CAP	4	PZ																		





COMPONENT			SPARE PART																										
Code	Description	Image	Code	Description	Components list																								
VM2310A	UPPER DOOR BRACKET HOLES COVER		KVM2310A	UPPER BRACKET HOLE COVER KIT	<table border="1"> <thead> <tr> <th>Code</th> <th>Description</th> <th>Qty</th> <th>UOM</th> </tr> </thead> <tbody> <tr> <td>VM2310A0</td> <td>UPPER DOOR BRACKET HOLES COVER</td> <td>1</td> <td>PZ</td> </tr> </tbody> </table>	Code	Description	Qty	UOM	VM2310A0	UPPER DOOR BRACKET HOLES COVER	1	PZ																
Code	Description	Qty	UOM																										
VM2310A0	UPPER DOOR BRACKET HOLES COVER	1	PZ																										
0H7675A																													
0D2305B	XEBC-04EU-E EXTERNAL TOP COVER																												
0D2308A																													
VM2061A	ACCESSORIES CABLES WALL PASSING		KVM1505A	THROUGH-WALL CONNECTION+DIAPHRAGM KIT	<table border="1"> <thead> <tr> <th>Code</th> <th>Description</th> <th>Qty</th> <th>UOM</th> </tr> </thead> <tbody> <tr> <td>VI1220A1</td> <td>4,2X12 TCB SELF-TAPPING SCREW</td> <td>1</td> <td>PZ</td> </tr> <tr> <td>VM1505A0</td> <td>WALL PASSING WITH DIAPHRAGM</td> <td>3</td> <td>PZ</td> </tr> <tr> <td>VM2055A0</td> <td>UPPER THROUGH-WALL CONNECTION</td> <td>1</td> <td>PZ</td> </tr> <tr> <td>VM2056A0</td> <td>LOWER THROUGH-WALL CONNECTION</td> <td>1</td> <td>PZ</td> </tr> <tr> <td>VM2061A0</td> <td>ACCESSORIES CABLES WALL PASSING</td> <td>1</td> <td>PZ</td> </tr> </tbody> </table>	Code	Description	Qty	UOM	VI1220A1	4,2X12 TCB SELF-TAPPING SCREW	1	PZ	VM1505A0	WALL PASSING WITH DIAPHRAGM	3	PZ	VM2055A0	UPPER THROUGH-WALL CONNECTION	1	PZ	VM2056A0	LOWER THROUGH-WALL CONNECTION	1	PZ	VM2061A0	ACCESSORIES CABLES WALL PASSING	1	PZ
Code	Description	Qty	UOM																										
VI1220A1	4,2X12 TCB SELF-TAPPING SCREW	1	PZ																										
VM1505A0	WALL PASSING WITH DIAPHRAGM	3	PZ																										
VM2055A0	UPPER THROUGH-WALL CONNECTION	1	PZ																										
VM2056A0	LOWER THROUGH-WALL CONNECTION	1	PZ																										
VM2061A0	ACCESSORIES CABLES WALL PASSING	1	PZ																										

COMPONENT			SPARE PART																										
Code	Description	Image	Code	Description	Components list																								
0D2309A																													
RC1365A	3/4"-10 JG FEMALE CONNECTION		KRC1365A	3/4"-10 OR 8 JG WATER CONNECTION KIT	<table border="1"> <thead> <tr> <th>Code</th> <th>Description</th> <th>Qty</th> <th>UOM</th> </tr> </thead> <tbody> <tr> <td>GN1200A1</td> <td>3/4 CONNECTION SEAL D=24 RUBBER+NET</td> <td>1</td> <td>PZ</td> </tr> <tr> <td>RC1002A0</td> <td>JG 10M-8F TERMINAL REDUCTION FITTING</td> <td>1</td> <td>PZ</td> </tr> <tr> <td>RC1365A0</td> <td>3/4"-10 JG FEMALE CONNECTION</td> <td>1</td> <td>PZ</td> </tr> </tbody> </table>	Code	Description	Qty	UOM	GN1200A1	3/4 CONNECTION SEAL D=24 RUBBER+NET	1	PZ	RC1002A0	JG 10M-8F TERMINAL REDUCTION FITTING	1	PZ	RC1365A0	3/4"-10 JG FEMALE CONNECTION	1	PZ								
Code	Description	Qty	UOM																										
GN1200A1	3/4 CONNECTION SEAL D=24 RUBBER+NET	1	PZ																										
RC1002A0	JG 10M-8F TERMINAL REDUCTION FITTING	1	PZ																										
RC1365A0	3/4"-10 JG FEMALE CONNECTION	1	PZ																										
VL1086A	LIMESCALE REMOVER NEODYMIUM MAGNET		KVL1086A	NEODYMIUM MAGNET ANTI-LIMESCALE KI	<table border="1"> <thead> <tr> <th>Code</th> <th>Description</th> <th>Qty</th> <th>UOM</th> </tr> </thead> <tbody> <tr> <td>VL1086A0</td> <td>LIMESCALE REMOVER NEODYMIUM MAGNET</td> <td>2</td> <td>PZ</td> </tr> </tbody> </table>	Code	Description	Qty	UOM	VL1086A0	LIMESCALE REMOVER NEODYMIUM MAGNET	2	PZ																
Code	Description	Qty	UOM																										
VL1086A0	LIMESCALE REMOVER NEODYMIUM MAGNET	2	PZ																										
VM1054A	H7.8 PRESSURE REDUCER RING NUT		KVM1054A	H7.8 PRESSURE REDUCER DIAL KIT	<table border="1"> <thead> <tr> <th>Code</th> <th>Description</th> <th>Qty</th> <th>UOM</th> </tr> </thead> <tbody> <tr> <td>VM1054A0</td> <td>H7.8 PRESSURE REDUCER RING NUT</td> <td>1</td> <td>PZ</td> </tr> </tbody> </table>	Code	Description	Qty	UOM	VM1054A0	H7.8 PRESSURE REDUCER RING NUT	1	PZ																
Code	Description	Qty	UOM																										
VM1054A0	H7.8 PRESSURE REDUCER RING NUT	1	PZ																										
			KVL1117A	EUR MM 2016+LMT FILTER+PRESS. RED. KIT	<table border="1"> <thead> <tr> <th>Code</th> <th>Description</th> <th>Qty</th> <th>UOM</th> </tr> </thead> <tbody> <tr> <td>0H7472A1</td> <td>DISTRIBUTOR SUPPORT PLATE</td> <td>1</td> <td>PZ</td> </tr> <tr> <td>RC1004A0</td> <td>Ø10-Ø8-8 Y CONNECTION</td> <td>1</td> <td>PZ</td> </tr> <tr> <td>RC1243A0</td> <td>Ø10F-Ø10M ELBOW CONNECTION + JG END KIT</td> <td>1</td> <td>PZ</td> </tr> <tr> <td>RC1372A0</td> <td>Ø10M-1/4 M CIL. STRAIGHT FITTING</td> <td>2</td> <td>PZ</td> </tr> <tr> <td>VI1013A1</td> <td>30.5X39.5X3 NYLON FLAT WASHER</td> <td>1</td> <td>PZ</td> </tr> </tbody> </table>	Code	Description	Qty	UOM	0H7472A1	DISTRIBUTOR SUPPORT PLATE	1	PZ	RC1004A0	Ø10-Ø8-8 Y CONNECTION	1	PZ	RC1243A0	Ø10F-Ø10M ELBOW CONNECTION + JG END KIT	1	PZ	RC1372A0	Ø10M-1/4 M CIL. STRAIGHT FITTING	2	PZ	VI1013A1	30.5X39.5X3 NYLON FLAT WASHER	1	PZ
Code	Description	Qty	UOM																										
0H7472A1	DISTRIBUTOR SUPPORT PLATE	1	PZ																										
RC1004A0	Ø10-Ø8-8 Y CONNECTION	1	PZ																										
RC1243A0	Ø10F-Ø10M ELBOW CONNECTION + JG END KIT	1	PZ																										
RC1372A0	Ø10M-1/4 M CIL. STRAIGHT FITTING	2	PZ																										
VI1013A1	30.5X39.5X3 NYLON FLAT WASHER	1	PZ																										

COMPONENT			SPARE PART																																						
Code	Description	Image	Code	Description	Components list																																				
VM1054A	H7.8 PRESSURE REDUCER RING NUT		KVL1117A	EUR MM 2016+LMT FILTER+PRESS. RED. KIT	<table border="1"> <thead> <tr> <th>Code</th> <th>Description</th> <th>Qty</th> <th>UOM</th> </tr> </thead> <tbody> <tr> <td>VI1220A1</td> <td>4,2X12 TCB SELF-TAPPIN G SCREW</td> <td>2</td> <td>PZ</td> </tr> <tr> <td>VL1014A0</td> <td>PRESSURE REDUCER WITH DISTRIBUTOR</td> <td>1</td> <td>PZ</td> </tr> <tr> <td>VL1014B0</td> <td>PRESSURE REDUCER WITH DISTRIBUTOR</td> <td>1</td> <td>PZ</td> </tr> <tr> <td>VL1014B1</td> <td>PRESSURE REDUCER WITH DISTRIBUTOR</td> <td>1</td> <td>PZ</td> </tr> <tr> <td>VL1034C0</td> <td>MESH WATER FILTER D10</td> <td>1</td> <td>PZ</td> </tr> <tr> <td>VL1062C0</td> <td>PRESSURE REDUCER-FIL TER LOCKING FORK</td> <td>1</td> <td>PZ</td> </tr> <tr> <td>VM1053A0</td> <td>1/8" CAP + O-RING</td> <td>2</td> <td>PZ</td> </tr> <tr> <td>VM1054A0</td> <td>H7.8 PRESSURE REDUCER RING NUT</td> <td>1</td> <td>PZ</td> </tr> </tbody> </table>	Code	Description	Qty	UOM	VI1220A1	4,2X12 TCB SELF-TAPPIN G SCREW	2	PZ	VL1014A0	PRESSURE REDUCER WITH DISTRIBUTOR	1	PZ	VL1014B0	PRESSURE REDUCER WITH DISTRIBUTOR	1	PZ	VL1014B1	PRESSURE REDUCER WITH DISTRIBUTOR	1	PZ	VL1034C0	MESH WATER FILTER D10	1	PZ	VL1062C0	PRESSURE REDUCER-FIL TER LOCKING FORK	1	PZ	VM1053A0	1/8" CAP + O-RING	2	PZ	VM1054A0	H7.8 PRESSURE REDUCER RING NUT	1	PZ
					Code	Description	Qty	UOM																																	
VI1220A1	4,2X12 TCB SELF-TAPPIN G SCREW	2	PZ																																						
VL1014A0	PRESSURE REDUCER WITH DISTRIBUTOR	1	PZ																																						
VL1014B0	PRESSURE REDUCER WITH DISTRIBUTOR	1	PZ																																						
VL1014B1	PRESSURE REDUCER WITH DISTRIBUTOR	1	PZ																																						
VL1034C0	MESH WATER FILTER D10	1	PZ																																						
VL1062C0	PRESSURE REDUCER-FIL TER LOCKING FORK	1	PZ																																						
VM1053A0	1/8" CAP + O-RING	2	PZ																																						
VM1054A0	H7.8 PRESSURE REDUCER RING NUT	1	PZ																																						
VL1034C	MESH WATER FILTER D10		KVL1117A	EUR MM 2016+LMT FILTER+PRESS. RED. KIT	<table border="1"> <thead> <tr> <th>Code</th> <th>Description</th> <th>Qty</th> <th>UOM</th> </tr> </thead> <tbody> <tr> <td>0H7472A1</td> <td>DISTRIBUTOR SUPPORT PLATE</td> <td>1</td> <td>PZ</td> </tr> <tr> <td>RC1004A0</td> <td>Ø10-Ø8-8 Y CONNECTION</td> <td>1</td> <td>PZ</td> </tr> <tr> <td>RC1243A0</td> <td>Ø10F-Ø10M ELBOW CONNECTION + JG END KIT</td> <td>1</td> <td>PZ</td> </tr> <tr> <td>RC1372A0</td> <td>Ø10M-1/4 M CIL. STRAIGHT FITTING</td> <td>2</td> <td>PZ</td> </tr> <tr> <td>VI1013A1</td> <td>30.5X39.5X3 NYLON FLAT WASHER</td> <td>1</td> <td>PZ</td> </tr> <tr> <td>VI1220A1</td> <td>4,2X12 TCB SELF-TAPPIN G SCREW</td> <td>2</td> <td>PZ</td> </tr> <tr> <td>VL1014A0</td> <td>PRESSURE REDUCER WITH DISTRIBUTOR</td> <td>1</td> <td>PZ</td> </tr> <tr> <td>VL1014B0</td> <td>PRESSURE REDUCER WITH DISTRIBUTOR</td> <td>1</td> <td>PZ</td> </tr> </tbody> </table>	Code	Description	Qty	UOM	0H7472A1	DISTRIBUTOR SUPPORT PLATE	1	PZ	RC1004A0	Ø10-Ø8-8 Y CONNECTION	1	PZ	RC1243A0	Ø10F-Ø10M ELBOW CONNECTION + JG END KIT	1	PZ	RC1372A0	Ø10M-1/4 M CIL. STRAIGHT FITTING	2	PZ	VI1013A1	30.5X39.5X3 NYLON FLAT WASHER	1	PZ	VI1220A1	4,2X12 TCB SELF-TAPPIN G SCREW	2	PZ	VL1014A0	PRESSURE REDUCER WITH DISTRIBUTOR	1	PZ	VL1014B0	PRESSURE REDUCER WITH DISTRIBUTOR	1	PZ
Code	Description	Qty	UOM																																						
0H7472A1	DISTRIBUTOR SUPPORT PLATE	1	PZ																																						
RC1004A0	Ø10-Ø8-8 Y CONNECTION	1	PZ																																						
RC1243A0	Ø10F-Ø10M ELBOW CONNECTION + JG END KIT	1	PZ																																						
RC1372A0	Ø10M-1/4 M CIL. STRAIGHT FITTING	2	PZ																																						
VI1013A1	30.5X39.5X3 NYLON FLAT WASHER	1	PZ																																						
VI1220A1	4,2X12 TCB SELF-TAPPIN G SCREW	2	PZ																																						
VL1014A0	PRESSURE REDUCER WITH DISTRIBUTOR	1	PZ																																						
VL1014B0	PRESSURE REDUCER WITH DISTRIBUTOR	1	PZ																																						

COMPONENT			SPARE PART																																		
Code	Description	Image	Code	Description	Components list																																
VL1034C	MESH WATER FILTER D10		KVL1117A	EUR MM 2016+LMT FILTER+PRESS. RED. KIT	<table border="1"> <thead> <tr> <th>Code</th> <th>Description</th> <th>Qty</th> <th>UOM</th> </tr> </thead> <tbody> <tr> <td>VL1014B1</td> <td>PRESSURE REDUCER WITH DISTRIBUTOR</td> <td>1</td> <td>PZ</td> </tr> <tr> <td>VL1034C0</td> <td>MESH WATER FILTER D10</td> <td>1</td> <td>PZ</td> </tr> <tr> <td>VL1062C0</td> <td>PRESSURE REDUCER-FILTER LOCKING FORK</td> <td>1</td> <td>PZ</td> </tr> <tr> <td>VM1053A0</td> <td>1/8" CAP + O-RING</td> <td>2</td> <td>PZ</td> </tr> <tr> <td>VM1054A0</td> <td>H7.8 PRESSURE REDUCER RING NUT</td> <td>1</td> <td>PZ</td> </tr> </tbody> </table>	Code	Description	Qty	UOM	VL1014B1	PRESSURE REDUCER WITH DISTRIBUTOR	1	PZ	VL1034C0	MESH WATER FILTER D10	1	PZ	VL1062C0	PRESSURE REDUCER-FILTER LOCKING FORK	1	PZ	VM1053A0	1/8" CAP + O-RING	2	PZ	VM1054A0	H7.8 PRESSURE REDUCER RING NUT	1	PZ								
			Code	Description	Qty	UOM																															
VL1014B1	PRESSURE REDUCER WITH DISTRIBUTOR	1	PZ																																		
VL1034C0	MESH WATER FILTER D10	1	PZ																																		
VL1062C0	PRESSURE REDUCER-FILTER LOCKING FORK	1	PZ																																		
VM1053A0	1/8" CAP + O-RING	2	PZ																																		
VM1054A0	H7.8 PRESSURE REDUCER RING NUT	1	PZ																																		
KVL1034C	Ø8-Ø10 MESH100 WATER FILTER KIT	<table border="1"> <thead> <tr> <th>Code</th> <th>Description</th> <th>Qty</th> <th>UOM</th> </tr> </thead> <tbody> <tr> <td>RC1002A0</td> <td>JG 10M-8F TERMINAL REDUCTION FITTING</td> <td>2</td> <td>PZ</td> </tr> <tr> <td>VL1034C0</td> <td>MESH WATER FILTER D10</td> <td>1</td> <td>PZ</td> </tr> <tr> <td>VL1062C0</td> <td>PRESSURE REDUCER-FILTER LOCKING FORK</td> <td>1</td> <td>PZ</td> </tr> </tbody> </table>	Code	Description	Qty	UOM	RC1002A0	JG 10M-8F TERMINAL REDUCTION FITTING	2	PZ	VL1034C0	MESH WATER FILTER D10	1	PZ	VL1062C0	PRESSURE REDUCER-FILTER LOCKING FORK	1	PZ																			
Code	Description	Qty	UOM																																		
RC1002A0	JG 10M-8F TERMINAL REDUCTION FITTING	2	PZ																																		
VL1034C0	MESH WATER FILTER D10	1	PZ																																		
VL1062C0	PRESSURE REDUCER-FILTER LOCKING FORK	1	PZ																																		
VL1062C	PRESSURE REDUCER-FILTER LOCKING FORK		KVL1117A	EUR MM 2016+LMT FILTER+PRESS. RED. KIT	<table border="1"> <thead> <tr> <th>Code</th> <th>Description</th> <th>Qty</th> <th>UOM</th> </tr> </thead> <tbody> <tr> <td>0H7472A1</td> <td>DISTRIBUTOR SUPPORT PLATE</td> <td>1</td> <td>PZ</td> </tr> <tr> <td>RC1004A0</td> <td>Ø10-Ø8-Y CONNECTION</td> <td>1</td> <td>PZ</td> </tr> <tr> <td>RC1243A0</td> <td>Ø10F-Ø10M ELBOW CONNECTION + JG END KIT</td> <td>1</td> <td>PZ</td> </tr> <tr> <td>RC1372A0</td> <td>Ø10M-1/4 M CIL. STRAIGHT FITTING</td> <td>2</td> <td>PZ</td> </tr> <tr> <td>VI1013A1</td> <td>30.5X39.5X3 NYLON FLAT WASHER</td> <td>1</td> <td>PZ</td> </tr> <tr> <td>VI1220A1</td> <td>4,2X12 TCB SELF-TAPPING SCREW</td> <td>2</td> <td>PZ</td> </tr> <tr> <td>VL1014A0</td> <td>PRESSURE REDUCER WITH DISTRIBUTOR</td> <td>1</td> <td>PZ</td> </tr> </tbody> </table>	Code	Description	Qty	UOM	0H7472A1	DISTRIBUTOR SUPPORT PLATE	1	PZ	RC1004A0	Ø10-Ø8-Y CONNECTION	1	PZ	RC1243A0	Ø10F-Ø10M ELBOW CONNECTION + JG END KIT	1	PZ	RC1372A0	Ø10M-1/4 M CIL. STRAIGHT FITTING	2	PZ	VI1013A1	30.5X39.5X3 NYLON FLAT WASHER	1	PZ	VI1220A1	4,2X12 TCB SELF-TAPPING SCREW	2	PZ	VL1014A0	PRESSURE REDUCER WITH DISTRIBUTOR	1	PZ
			Code	Description	Qty	UOM																															
			0H7472A1	DISTRIBUTOR SUPPORT PLATE	1	PZ																															
			RC1004A0	Ø10-Ø8-Y CONNECTION	1	PZ																															
			RC1243A0	Ø10F-Ø10M ELBOW CONNECTION + JG END KIT	1	PZ																															
			RC1372A0	Ø10M-1/4 M CIL. STRAIGHT FITTING	2	PZ																															
			VI1013A1	30.5X39.5X3 NYLON FLAT WASHER	1	PZ																															
			VI1220A1	4,2X12 TCB SELF-TAPPING SCREW	2	PZ																															
VL1014A0	PRESSURE REDUCER WITH DISTRIBUTOR	1	PZ																																		



COMPONENT			SPARE PART																																														
Code	Description	Image	Code	Description	Components list																																												
VL1062C	PRESSURE REDUCER-FILTER LOCKING FORK		KVL1117A	EUR MM 2016+LMT FILTER+PRESS. RED. KIT	<table border="1"> <thead> <tr> <th>Code</th> <th>Description</th> <th>Qty</th> <th>UOM</th> </tr> </thead> <tbody> <tr> <td>VL1014B0</td> <td>PRESSURE REDUCER WITH DISTRIBUTOR</td> <td>1</td> <td>PZ</td> </tr> <tr> <td>VL1014B1</td> <td>PRESSURE REDUCER WITH DISTRIBUTOR</td> <td>1</td> <td>PZ</td> </tr> <tr> <td>VL1034C0</td> <td>MESH WATER FILTER D10</td> <td>1</td> <td>PZ</td> </tr> <tr> <td>VL1062C0</td> <td>PRESSURE REDUCER-FIL TER LOCKING FORK</td> <td>1</td> <td>PZ</td> </tr> <tr> <td>VM1053A0</td> <td>1/8" CAP + O-RING</td> <td>2</td> <td>PZ</td> </tr> <tr> <td>VM1054A0</td> <td>H7.8 PRESSURE REDUCER RING NUT</td> <td>1</td> <td>PZ</td> </tr> </tbody> </table>	Code	Description	Qty	UOM	VL1014B0	PRESSURE REDUCER WITH DISTRIBUTOR	1	PZ	VL1014B1	PRESSURE REDUCER WITH DISTRIBUTOR	1	PZ	VL1034C0	MESH WATER FILTER D10	1	PZ	VL1062C0	PRESSURE REDUCER-FIL TER LOCKING FORK	1	PZ	VM1053A0	1/8" CAP + O-RING	2	PZ	VM1054A0	H7.8 PRESSURE REDUCER RING NUT	1	PZ																
Code	Description	Qty	UOM																																														
VL1014B0	PRESSURE REDUCER WITH DISTRIBUTOR	1	PZ																																														
VL1014B1	PRESSURE REDUCER WITH DISTRIBUTOR	1	PZ																																														
VL1034C0	MESH WATER FILTER D10	1	PZ																																														
VL1062C0	PRESSURE REDUCER-FIL TER LOCKING FORK	1	PZ																																														
VM1053A0	1/8" CAP + O-RING	2	PZ																																														
VM1054A0	H7.8 PRESSURE REDUCER RING NUT	1	PZ																																														
0H7472A	DISTRIBUTOR SUPPORT PLATE		KVL1117A	EUR MM 2016+LMT FILTER+PRESS. RED. KIT	<table border="1"> <thead> <tr> <th>Code</th> <th>Description</th> <th>Qty</th> <th>UOM</th> </tr> </thead> <tbody> <tr> <td>0H7472A1</td> <td>DISTRIBUTOR SUPPORT PLATE</td> <td>1</td> <td>PZ</td> </tr> <tr> <td>RC1004A0</td> <td>Ø10-Ø8 Y CONNECTION</td> <td>1</td> <td>PZ</td> </tr> <tr> <td>RC1243A0</td> <td>Ø10F-Ø10M ELBOW CONNECTION + JG END KIT</td> <td>1</td> <td>PZ</td> </tr> <tr> <td>RC1372A0</td> <td>Ø10M-1/4 M CIL. STRAIGHT FITTING</td> <td>2</td> <td>PZ</td> </tr> <tr> <td>V11013A1</td> <td>30.5X39.5X3 NYLON FLAT WASHER</td> <td>1</td> <td>PZ</td> </tr> <tr> <td>V11220A1</td> <td>4,2X12 TCB SELF-TAPPIN G SCREW</td> <td>2</td> <td>PZ</td> </tr> <tr> <td>VL1014A0</td> <td>PRESSURE REDUCER WITH DISTRIBUTOR</td> <td>1</td> <td>PZ</td> </tr> <tr> <td>VL1014B0</td> <td>PRESSURE REDUCER WITH DISTRIBUTOR</td> <td>1</td> <td>PZ</td> </tr> <tr> <td>VL1014B1</td> <td>PRESSURE REDUCER WITH DISTRIBUTOR</td> <td>1</td> <td>PZ</td> </tr> <tr> <td>VL1034C0</td> <td>MESH WATER FILTER D10</td> <td>1</td> <td>PZ</td> </tr> </tbody> </table>	Code	Description	Qty	UOM	0H7472A1	DISTRIBUTOR SUPPORT PLATE	1	PZ	RC1004A0	Ø10-Ø8 Y CONNECTION	1	PZ	RC1243A0	Ø10F-Ø10M ELBOW CONNECTION + JG END KIT	1	PZ	RC1372A0	Ø10M-1/4 M CIL. STRAIGHT FITTING	2	PZ	V11013A1	30.5X39.5X3 NYLON FLAT WASHER	1	PZ	V11220A1	4,2X12 TCB SELF-TAPPIN G SCREW	2	PZ	VL1014A0	PRESSURE REDUCER WITH DISTRIBUTOR	1	PZ	VL1014B0	PRESSURE REDUCER WITH DISTRIBUTOR	1	PZ	VL1014B1	PRESSURE REDUCER WITH DISTRIBUTOR	1	PZ	VL1034C0	MESH WATER FILTER D10	1	PZ
Code	Description	Qty	UOM																																														
0H7472A1	DISTRIBUTOR SUPPORT PLATE	1	PZ																																														
RC1004A0	Ø10-Ø8 Y CONNECTION	1	PZ																																														
RC1243A0	Ø10F-Ø10M ELBOW CONNECTION + JG END KIT	1	PZ																																														
RC1372A0	Ø10M-1/4 M CIL. STRAIGHT FITTING	2	PZ																																														
V11013A1	30.5X39.5X3 NYLON FLAT WASHER	1	PZ																																														
V11220A1	4,2X12 TCB SELF-TAPPIN G SCREW	2	PZ																																														
VL1014A0	PRESSURE REDUCER WITH DISTRIBUTOR	1	PZ																																														
VL1014B0	PRESSURE REDUCER WITH DISTRIBUTOR	1	PZ																																														
VL1014B1	PRESSURE REDUCER WITH DISTRIBUTOR	1	PZ																																														
VL1034C0	MESH WATER FILTER D10	1	PZ																																														

COMPONENT			SPARE PART																																						
Code	Description	Image	Code	Description	Components list																																				
0H7472A	DISTRIBUTOR SUPPORT PLATE		KVL1117A	EUR MM 2016+LMT FILTER+PRESS. RED. KIT	<table border="1"> <thead> <tr> <th>Code</th> <th>Description</th> <th>Qty</th> <th>UOM</th> </tr> </thead> <tbody> <tr> <td>VL1062C0</td> <td>PRESSURE REDUCER-FIL TER LOCKING FORK</td> <td>1</td> <td>PZ</td> </tr> <tr> <td>VM1053A0</td> <td>1/8" CAP + O-RING</td> <td>2</td> <td>PZ</td> </tr> <tr> <td>VM1054A0</td> <td>H7.8 PRESSURE REDUCER RING NUT</td> <td>1</td> <td>PZ</td> </tr> </tbody> </table>	Code	Description	Qty	UOM	VL1062C0	PRESSURE REDUCER-FIL TER LOCKING FORK	1	PZ	VM1053A0	1/8" CAP + O-RING	2	PZ	VM1054A0	H7.8 PRESSURE REDUCER RING NUT	1	PZ																				
			Code	Description	Qty	UOM																																			
VL1062C0	PRESSURE REDUCER-FIL TER LOCKING FORK	1	PZ																																						
VM1053A0	1/8" CAP + O-RING	2	PZ																																						
VM1054A0	H7.8 PRESSURE REDUCER RING NUT	1	PZ																																						
K0H7472A	DISTRIBUTOR SUPPORT PLATE KI	<table border="1"> <thead> <tr> <th>Code</th> <th>Description</th> <th>Qty</th> <th>UOM</th> </tr> </thead> <tbody> <tr> <td>0H7472A0</td> <td></td> <td>1</td> <td>PZ</td> </tr> <tr> <td>0H7472A1</td> <td>DISTRIBUTOR SUPPORT PLATE</td> <td>1</td> <td>PZ</td> </tr> </tbody> </table>	Code	Description	Qty	UOM	0H7472A0		1	PZ	0H7472A1	DISTRIBUTOR SUPPORT PLATE	1	PZ																											
Code	Description	Qty	UOM																																						
0H7472A0		1	PZ																																						
0H7472A1	DISTRIBUTOR SUPPORT PLATE	1	PZ																																						
VL1125A	BENDE FITTING M-M RUBBER-HOLDER D8-END		KTB2237A	1,5M D10 TB2243A CONNECTION PIPE KIT	<table border="1"> <thead> <tr> <th>Code</th> <th>Description</th> <th>Qty</th> <th>UOM</th> </tr> </thead> <tbody> <tr> <td>TB2243A0</td> <td>Ø10 PET PIPE</td> <td>1.500</td> <td>M</td> </tr> </tbody> </table>	Code	Description	Qty	UOM	TB2243A0	Ø10 PET PIPE	1.500	M																												
Code	Description	Qty	UOM																																						
TB2243A0	Ø10 PET PIPE	1.500	M																																						
RC1372A	Ø10M-1/4 M CIL. STRAIGHT FITTING		KVL1117A	EUR MM 2016+LMT FILTER+PRESS. RED. KIT	<table border="1"> <thead> <tr> <th>Code</th> <th>Description</th> <th>Qty</th> <th>UOM</th> </tr> </thead> <tbody> <tr> <td>0H7472A1</td> <td>DISTRIBUTOR SUPPORT PLATE</td> <td>1</td> <td>PZ</td> </tr> <tr> <td>RC1004A0</td> <td>Ø10-Ø8-8 Y CONNECTION</td> <td>1</td> <td>PZ</td> </tr> <tr> <td>RC1243A0</td> <td>Ø10F-Ø10M ELBOW CONNECTION + JG END KIT</td> <td>1</td> <td>PZ</td> </tr> <tr> <td>RC1372A0</td> <td>Ø10M-1/4 M CIL. STRAIGHT FITTING</td> <td>2</td> <td>PZ</td> </tr> <tr> <td>V11013A1</td> <td>30.5X39.5X3 NYLON FLAT WASHER</td> <td>1</td> <td>PZ</td> </tr> <tr> <td>V11220A1</td> <td>4,2X12 TCB SELF-TAPPIN G SCREW</td> <td>2</td> <td>PZ</td> </tr> <tr> <td>VL1014A0</td> <td>PRESSURE REDUCER WITH DISTRIBUTOR</td> <td>1</td> <td>PZ</td> </tr> <tr> <td>VL1014B0</td> <td>PRESSURE REDUCER WITH DISTRIBUTOR</td> <td>1</td> <td>PZ</td> </tr> </tbody> </table>	Code	Description	Qty	UOM	0H7472A1	DISTRIBUTOR SUPPORT PLATE	1	PZ	RC1004A0	Ø10-Ø8-8 Y CONNECTION	1	PZ	RC1243A0	Ø10F-Ø10M ELBOW CONNECTION + JG END KIT	1	PZ	RC1372A0	Ø10M-1/4 M CIL. STRAIGHT FITTING	2	PZ	V11013A1	30.5X39.5X3 NYLON FLAT WASHER	1	PZ	V11220A1	4,2X12 TCB SELF-TAPPIN G SCREW	2	PZ	VL1014A0	PRESSURE REDUCER WITH DISTRIBUTOR	1	PZ	VL1014B0	PRESSURE REDUCER WITH DISTRIBUTOR	1	PZ
			Code	Description	Qty	UOM																																			
			0H7472A1	DISTRIBUTOR SUPPORT PLATE	1	PZ																																			
			RC1004A0	Ø10-Ø8-8 Y CONNECTION	1	PZ																																			
			RC1243A0	Ø10F-Ø10M ELBOW CONNECTION + JG END KIT	1	PZ																																			
			RC1372A0	Ø10M-1/4 M CIL. STRAIGHT FITTING	2	PZ																																			
			V11013A1	30.5X39.5X3 NYLON FLAT WASHER	1	PZ																																			
			V11220A1	4,2X12 TCB SELF-TAPPIN G SCREW	2	PZ																																			
			VL1014A0	PRESSURE REDUCER WITH DISTRIBUTOR	1	PZ																																			
VL1014B0	PRESSURE REDUCER WITH DISTRIBUTOR	1	PZ																																						





COMPONENT			SPARE PART																																														
Code	Description	Image	Code	Description	Components list																																												
RC1372A	Ø10M-1/4 M CIL. STRAIGHT FITTING		KVL1117A	EUR MM 2016+LMT FILTER+PRESS. RED. KIT	<table border="1"> <thead> <tr> <th>Code</th> <th>Description</th> <th>Qty</th> <th>UOM</th> </tr> </thead> <tbody> <tr> <td>VL1014B1</td> <td>PRESSURE REDUCER WITH DISTRIBUTOR</td> <td>1</td> <td>PZ</td> </tr> <tr> <td>VL1034C0</td> <td>MESH WATER FILTER D10</td> <td>1</td> <td>PZ</td> </tr> <tr> <td>VL1062C0</td> <td>PRESSURE REDUCER-FIL TER LOCKING FORK</td> <td>1</td> <td>PZ</td> </tr> <tr> <td>VM1053A0</td> <td>1/8" CAP + O-RING</td> <td>2</td> <td>PZ</td> </tr> <tr> <td>VM1054A0</td> <td>H7.8 PRESSURE REDUCER RING NUT</td> <td>1</td> <td>PZ</td> </tr> </tbody> </table>	Code	Description	Qty	UOM	VL1014B1	PRESSURE REDUCER WITH DISTRIBUTOR	1	PZ	VL1034C0	MESH WATER FILTER D10	1	PZ	VL1062C0	PRESSURE REDUCER-FIL TER LOCKING FORK	1	PZ	VM1053A0	1/8" CAP + O-RING	2	PZ	VM1054A0	H7.8 PRESSURE REDUCER RING NUT	1	PZ																				
			Code	Description	Qty	UOM																																											
VL1014B1	PRESSURE REDUCER WITH DISTRIBUTOR	1	PZ																																														
VL1034C0	MESH WATER FILTER D10	1	PZ																																														
VL1062C0	PRESSURE REDUCER-FIL TER LOCKING FORK	1	PZ																																														
VM1053A0	1/8" CAP + O-RING	2	PZ																																														
VM1054A0	H7.8 PRESSURE REDUCER RING NUT	1	PZ																																														
KRC1372A	D 10M-1/4 M CIL STRAIGHT CONNECTION KIT	<table border="1"> <thead> <tr> <th>Code</th> <th>Description</th> <th>Qty</th> <th>UOM</th> </tr> </thead> <tbody> <tr> <td>RC1372A0</td> <td>Ø10M-1/4 M CIL. STRAIGHT FITTING</td> <td>1</td> <td>PZ</td> </tr> </tbody> </table>	Code	Description	Qty	UOM	RC1372A0	Ø10M-1/4 M CIL. STRAIGHT FITTING	1	PZ																																							
Code	Description	Qty	UOM																																														
RC1372A0	Ø10M-1/4 M CIL. STRAIGHT FITTING	1	PZ																																														
VL1014B	PRESSURE REDUCER WITH DISTRIBUTOR		KVL1117A	EUR MM 2016+LMT FILTER+PRESS. RED. KIT	<table border="1"> <thead> <tr> <th>Code</th> <th>Description</th> <th>Qty</th> <th>UOM</th> </tr> </thead> <tbody> <tr> <td>0H7472A1</td> <td>DISTRIBUTOR SUPPORT PLATE</td> <td>1</td> <td>PZ</td> </tr> <tr> <td>RC1004A0</td> <td>Ø10-Ø8.8 Y CONNECTION</td> <td>1</td> <td>PZ</td> </tr> <tr> <td>RC1243A0</td> <td>Ø10F-Ø10M ELBOW CONNECTION + JG END KIT</td> <td>1</td> <td>PZ</td> </tr> <tr> <td>RC1372A0</td> <td>Ø10M-1/4 M CIL. STRAIGHT FITTING</td> <td>2</td> <td>PZ</td> </tr> <tr> <td>VI1013A1</td> <td>30.5X39.5X3 NYLON FLAT WASHER</td> <td>1</td> <td>PZ</td> </tr> <tr> <td>VI1220A1</td> <td>4,2X12 TCB SELF-TAPPIN G SCREW</td> <td>2</td> <td>PZ</td> </tr> <tr> <td>VL1014A0</td> <td>PRESSURE REDUCER WITH DISTRIBUTOR</td> <td>1</td> <td>PZ</td> </tr> <tr> <td>VL1014B0</td> <td>PRESSURE REDUCER WITH DISTRIBUTOR</td> <td>1</td> <td>PZ</td> </tr> <tr> <td>VL1014B1</td> <td>PRESSURE REDUCER WITH DISTRIBUTOR</td> <td>1</td> <td>PZ</td> </tr> <tr> <td>VL1034C0</td> <td>MESH WATER FILTER D10</td> <td>1</td> <td>PZ</td> </tr> </tbody> </table>	Code	Description	Qty	UOM	0H7472A1	DISTRIBUTOR SUPPORT PLATE	1	PZ	RC1004A0	Ø10-Ø8.8 Y CONNECTION	1	PZ	RC1243A0	Ø10F-Ø10M ELBOW CONNECTION + JG END KIT	1	PZ	RC1372A0	Ø10M-1/4 M CIL. STRAIGHT FITTING	2	PZ	VI1013A1	30.5X39.5X3 NYLON FLAT WASHER	1	PZ	VI1220A1	4,2X12 TCB SELF-TAPPIN G SCREW	2	PZ	VL1014A0	PRESSURE REDUCER WITH DISTRIBUTOR	1	PZ	VL1014B0	PRESSURE REDUCER WITH DISTRIBUTOR	1	PZ	VL1014B1	PRESSURE REDUCER WITH DISTRIBUTOR	1	PZ	VL1034C0	MESH WATER FILTER D10	1	PZ
Code	Description	Qty	UOM																																														
0H7472A1	DISTRIBUTOR SUPPORT PLATE	1	PZ																																														
RC1004A0	Ø10-Ø8.8 Y CONNECTION	1	PZ																																														
RC1243A0	Ø10F-Ø10M ELBOW CONNECTION + JG END KIT	1	PZ																																														
RC1372A0	Ø10M-1/4 M CIL. STRAIGHT FITTING	2	PZ																																														
VI1013A1	30.5X39.5X3 NYLON FLAT WASHER	1	PZ																																														
VI1220A1	4,2X12 TCB SELF-TAPPIN G SCREW	2	PZ																																														
VL1014A0	PRESSURE REDUCER WITH DISTRIBUTOR	1	PZ																																														
VL1014B0	PRESSURE REDUCER WITH DISTRIBUTOR	1	PZ																																														
VL1014B1	PRESSURE REDUCER WITH DISTRIBUTOR	1	PZ																																														
VL1034C0	MESH WATER FILTER D10	1	PZ																																														

COMPONENT			SPARE PART																											
Code	Description	Image	Code	Description	Components list																									
VL1014B	PRESSURE REDUCER WITH DISTRIBUTOR		KVL1117A	EUR MM 2016+LMT FILTER+PRESS. RED. KIT	<table border="1"> <thead> <tr> <th>Code</th> <th>Description</th> <th>Qty</th> <th>UOM</th> </tr> </thead> <tbody> <tr> <td>VL1062C0</td> <td>PRESSURE REDUCER-FILTER LOCKING FORK</td> <td>1</td> <td>PZ</td> </tr> <tr> <td>VM1053A0</td> <td>1/8" CAP + O-RING</td> <td>2</td> <td>PZ</td> </tr> <tr> <td>VM1054A0</td> <td>H7.8 PRESSURE REDUCER RING NUT</td> <td>1</td> <td>PZ</td> </tr> </tbody> </table>	Code	Description	Qty	UOM	VL1062C0	PRESSURE REDUCER-FILTER LOCKING FORK	1	PZ	VM1053A0	1/8" CAP + O-RING	2	PZ	VM1054A0	H7.8 PRESSURE REDUCER RING NUT	1	PZ									
			Code	Description	Qty	UOM																								
			VL1062C0	PRESSURE REDUCER-FILTER LOCKING FORK	1	PZ																								
VM1053A0	1/8" CAP + O-RING	2	PZ																											
VM1054A0	H7.8 PRESSURE REDUCER RING NUT	1	PZ																											
KVL0014B	EUR 2017 MIND.MAPS PRESSURE REDUCER KIT	<table border="1"> <thead> <tr> <th>Code</th> <th>Description</th> <th>Qty</th> <th>UOM</th> </tr> </thead> <tbody> <tr> <td>RC1372A0</td> <td>Ø10M-1/4 M CIL. STRAIGHT FITTING</td> <td>1</td> <td>PZ</td> </tr> <tr> <td>RC1396A0</td> <td>JG D10-1/4 STRAIGHT END FITTING</td> <td>1</td> <td>PZ</td> </tr> <tr> <td>VL1014B0</td> <td>PRESSURE REDUCER WITH DISTRIBUTOR</td> <td>1</td> <td>PZ</td> </tr> <tr> <td>VL1014B1</td> <td>PRESSURE REDUCER WITH DISTRIBUTOR</td> <td>1</td> <td>PZ</td> </tr> <tr> <td>VM1054A0</td> <td>H7.8 PRESSURE REDUCER RING NUT</td> <td>1</td> <td>PZ</td> </tr> </tbody> </table>	Code	Description	Qty	UOM	RC1372A0	Ø10M-1/4 M CIL. STRAIGHT FITTING	1	PZ	RC1396A0	JG D10-1/4 STRAIGHT END FITTING	1	PZ	VL1014B0	PRESSURE REDUCER WITH DISTRIBUTOR	1	PZ	VL1014B1	PRESSURE REDUCER WITH DISTRIBUTOR	1	PZ	VM1054A0	H7.8 PRESSURE REDUCER RING NUT	1	PZ				
Code	Description	Qty	UOM																											
RC1372A0	Ø10M-1/4 M CIL. STRAIGHT FITTING	1	PZ																											
RC1396A0	JG D10-1/4 STRAIGHT END FITTING	1	PZ																											
VL1014B0	PRESSURE REDUCER WITH DISTRIBUTOR	1	PZ																											
VL1014B1	PRESSURE REDUCER WITH DISTRIBUTOR	1	PZ																											
VM1054A0	H7.8 PRESSURE REDUCER RING NUT	1	PZ																											
KVL0014A	EUR MIND.MAPS PRESSURE REDUCER KIT	<table border="1"> <thead> <tr> <th>Code</th> <th>Description</th> <th>Qty</th> <th>UOM</th> </tr> </thead> <tbody> <tr> <td>RC1372A0</td> <td>Ø10M-1/4 M CIL. STRAIGHT FITTING</td> <td>2</td> <td>PZ</td> </tr> <tr> <td>VL1014A0</td> <td>PRESSURE REDUCER WITH DISTRIBUTOR</td> <td>1</td> <td>PZ</td> </tr> <tr> <td>VL1014B0</td> <td>PRESSURE REDUCER WITH DISTRIBUTOR</td> <td>1</td> <td>PZ</td> </tr> <tr> <td>VL1014B1</td> <td>PRESSURE REDUCER WITH DISTRIBUTOR</td> <td>1</td> <td>PZ</td> </tr> <tr> <td>VM1053A0</td> <td>1/8" CAP + O-RING</td> <td>2</td> <td>PZ</td> </tr> <tr> <td>VM1054A0</td> <td>H7.8 PRESSURE REDUCER RING NUT</td> <td>1</td> <td>PZ</td> </tr> </tbody> </table>	Code	Description	Qty	UOM	RC1372A0	Ø10M-1/4 M CIL. STRAIGHT FITTING	2	PZ	VL1014A0	PRESSURE REDUCER WITH DISTRIBUTOR	1	PZ	VL1014B0	PRESSURE REDUCER WITH DISTRIBUTOR	1	PZ	VL1014B1	PRESSURE REDUCER WITH DISTRIBUTOR	1	PZ	VM1053A0	1/8" CAP + O-RING	2	PZ	VM1054A0	H7.8 PRESSURE REDUCER RING NUT	1	PZ
Code	Description	Qty	UOM																											
RC1372A0	Ø10M-1/4 M CIL. STRAIGHT FITTING	2	PZ																											
VL1014A0	PRESSURE REDUCER WITH DISTRIBUTOR	1	PZ																											
VL1014B0	PRESSURE REDUCER WITH DISTRIBUTOR	1	PZ																											
VL1014B1	PRESSURE REDUCER WITH DISTRIBUTOR	1	PZ																											
VM1053A0	1/8" CAP + O-RING	2	PZ																											
VM1054A0	H7.8 PRESSURE REDUCER RING NUT	1	PZ																											

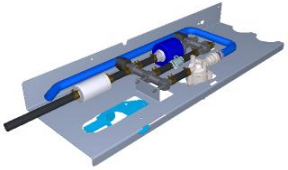
COMPONENT			SPARE PART																										
Code	Description	Image	Code	Description	Components list																								
VL1014B	PRESSURE REDUCER WITH DISTRIBUTOR		KVL0010A	S.4 - 5 WATER PRESSURE REDUCER KIT	<table border="1"> <thead> <tr> <th>Code</th> <th>Description</th> <th>Qty</th> <th>UOM</th> </tr> </thead> <tbody> <tr> <td>EL1210A0</td> <td>D8-BSP1/4 JG STRAIGHT END CONNECTION</td> <td>2</td> <td>PZ</td> </tr> <tr> <td>VL1014A0</td> <td>PRESSURE REDUCER WITH DISTRIBUTOR</td> <td>1</td> <td>PZ</td> </tr> <tr> <td>VL1014B0</td> <td>PRESSURE REDUCER WITH DISTRIBUTOR</td> <td>1</td> <td>PZ</td> </tr> <tr> <td>VL1014B1</td> <td>PRESSURE REDUCER WITH DISTRIBUTOR</td> <td>1</td> <td>PZ</td> </tr> <tr> <td>VM1053A0</td> <td>1/8" CAP + O-RING</td> <td>2</td> <td>PZ</td> </tr> </tbody> </table>	Code	Description	Qty	UOM	EL1210A0	D8-BSP1/4 JG STRAIGHT END CONNECTION	2	PZ	VL1014A0	PRESSURE REDUCER WITH DISTRIBUTOR	1	PZ	VL1014B0	PRESSURE REDUCER WITH DISTRIBUTOR	1	PZ	VL1014B1	PRESSURE REDUCER WITH DISTRIBUTOR	1	PZ	VM1053A0	1/8" CAP + O-RING	2	PZ
					Code	Description	Qty	UOM																					
					EL1210A0	D8-BSP1/4 JG STRAIGHT END CONNECTION	2	PZ																					
					VL1014A0	PRESSURE REDUCER WITH DISTRIBUTOR	1	PZ																					
					VL1014B0	PRESSURE REDUCER WITH DISTRIBUTOR	1	PZ																					
VL1014B1	PRESSURE REDUCER WITH DISTRIBUTOR	1	PZ																										
VM1053A0	1/8" CAP + O-RING	2	PZ																										
RC1396A	JG D10-1/4 STRAIGHT END FITTING		KVL0014B	EUR 2017 MIND.MAPS PRESSURE REDUCER KIT	<table border="1"> <thead> <tr> <th>Code</th> <th>Description</th> <th>Qty</th> <th>UOM</th> </tr> </thead> <tbody> <tr> <td>RC1372A0</td> <td>Ø10M-1/4 M CIL. STRAIGHT FITTING</td> <td>1</td> <td>PZ</td> </tr> <tr> <td>RC1396A0</td> <td>JG D10-1/4 STRAIGHT END FITTING</td> <td>1</td> <td>PZ</td> </tr> <tr> <td>VL1014B0</td> <td>PRESSURE REDUCER WITH DISTRIBUTOR</td> <td>1</td> <td>PZ</td> </tr> <tr> <td>VL1014B1</td> <td>PRESSURE REDUCER WITH DISTRIBUTOR</td> <td>1</td> <td>PZ</td> </tr> <tr> <td>VM1054A0</td> <td>H7.8 PRESSURE REDUCER RING NUT</td> <td>1</td> <td>PZ</td> </tr> </tbody> </table>	Code	Description	Qty	UOM	RC1372A0	Ø10M-1/4 M CIL. STRAIGHT FITTING	1	PZ	RC1396A0	JG D10-1/4 STRAIGHT END FITTING	1	PZ	VL1014B0	PRESSURE REDUCER WITH DISTRIBUTOR	1	PZ	VL1014B1	PRESSURE REDUCER WITH DISTRIBUTOR	1	PZ	VM1054A0	H7.8 PRESSURE REDUCER RING NUT	1	PZ
					Code	Description	Qty	UOM																					
					RC1372A0	Ø10M-1/4 M CIL. STRAIGHT FITTING	1	PZ																					
					RC1396A0	JG D10-1/4 STRAIGHT END FITTING	1	PZ																					
					VL1014B0	PRESSURE REDUCER WITH DISTRIBUTOR	1	PZ																					
VL1014B1	PRESSURE REDUCER WITH DISTRIBUTOR	1	PZ																										
VM1054A0	H7.8 PRESSURE REDUCER RING NUT	1	PZ																										
VL1063A	HOSE D8 TANG D10		KVL1063A	Ø8 PIPE HOLDER+Ø10 JG TERMINAL 10PCS KI	<table border="1"> <thead> <tr> <th>Code</th> <th>Description</th> <th>Qty</th> <th>UOM</th> </tr> </thead> <tbody> <tr> <td>VL1063A0</td> <td>HOSE D8 TANG D10</td> <td>10</td> <td>PZ</td> </tr> </tbody> </table>	Code	Description	Qty	UOM	VL1063A0	HOSE D8 TANG D10	10	PZ																
Code	Description	Qty	UOM																										
VL1063A0	HOSE D8 TANG D10	10	PZ																										

COMPONENT			SPARE PART																						
Code	Description	Image	Code	Description	Components list																				
RC1046A	D10-16 H9 ST STEEL HOSE CLAMP		KTB2237A	1,5M D10 TB2243A CONNECTION PIPE KIT	<table border="1"> <thead> <tr> <th>Code</th> <th>Description</th> <th>Qty</th> <th>UOM</th> </tr> </thead> <tbody> <tr> <td>TB2243A0</td> <td>Ø10 PET PIPE</td> <td>1.500</td> <td>M</td> </tr> </tbody> </table>	Code	Description	Qty	UOM	TB2243A0	Ø10 PET PIPE	1.500	M												
Code	Description	Qty	UOM																						
TB2243A0	Ø10 PET PIPE	1.500	M																						
VL1096A	T SHAPED FITTING 2X RUBBER HOLDER D6-D10		KVL1096A	T - SHAPED FIT-D6-D10 HOLD-2 MAGNETS KIT	<table border="1"> <thead> <tr> <th>Code</th> <th>Description</th> <th>Qty</th> <th>UOM</th> </tr> </thead> <tbody> <tr> <td>RC1018A0</td> <td>ZINC PLATED D12 ELASTIC CLAMP</td> <td>2</td> <td>PZ</td> </tr> <tr> <td>VL1086A0</td> <td>LIMESCALE REMOVER NEODYMIUM MAGNET</td> <td>2</td> <td>PZ</td> </tr> <tr> <td>VL1096A0</td> <td>T SHAPED FITTING 2X RUBBER HOLDER D6-D10</td> <td>1</td> <td>PZ</td> </tr> <tr> <td>VL1096A1</td> <td>2PCS T-SHAPED FIT-D6-D10 HOLD-MAGNE</td> <td>1</td> <td>PZ</td> </tr> </tbody> </table>	Code	Description	Qty	UOM	RC1018A0	ZINC PLATED D12 ELASTIC CLAMP	2	PZ	VL1086A0	LIMESCALE REMOVER NEODYMIUM MAGNET	2	PZ	VL1096A0	T SHAPED FITTING 2X RUBBER HOLDER D6-D10	1	PZ	VL1096A1	2PCS T-SHAPED FIT-D6-D10 HOLD-MAGNE	1	PZ
Code	Description	Qty	UOM																						
RC1018A0	ZINC PLATED D12 ELASTIC CLAMP	2	PZ																						
VL1086A0	LIMESCALE REMOVER NEODYMIUM MAGNET	2	PZ																						
VL1096A0	T SHAPED FITTING 2X RUBBER HOLDER D6-D10	1	PZ																						
VL1096A1	2PCS T-SHAPED FIT-D6-D10 HOLD-MAGNE	1	PZ																						
0E1351C	XEBC EXTERNAL BOTTOM PANEL		0E1351C0	XEBC EXTERNAL BOTTOM PANEL																					
EL1438A	SOLENOID VALVE 2 EXIT 5+9 BARBED 6		KEL1438A	5+9 BARBED 6 STEAM SOLENOID VALVE KIT	<table border="1"> <thead> <tr> <th>Code</th> <th>Description</th> <th>Qty</th> <th>UOM</th> </tr> </thead> <tbody> <tr> <td>EL1438A0</td> <td>SOLENOID VALVE 2 EXIT 5+9 BARBED 6</td> <td>1</td> <td>PZ</td> </tr> <tr> <td>RC1018A0</td> <td>ZINC PLATED D12 ELASTIC CLAMP</td> <td>2</td> <td>PZ</td> </tr> </tbody> </table>	Code	Description	Qty	UOM	EL1438A0	SOLENOID VALVE 2 EXIT 5+9 BARBED 6	1	PZ	RC1018A0	ZINC PLATED D12 ELASTIC CLAMP	2	PZ								
Code	Description	Qty	UOM																						
EL1438A0	SOLENOID VALVE 2 EXIT 5+9 BARBED 6	1	PZ																						
RC1018A0	ZINC PLATED D12 ELASTIC CLAMP	2	PZ																						

COMPONENT			SPARE PART																																																																														
Code	Description	Image	Code	Description	Components list																																																																												
VL1106B			KVL1106A	EUR 1 ROTOR ARM ONE CLEANING SYSTEM KIT	<table border="1"> <thead> <tr> <th>Code</th> <th>Description</th> <th>Qty</th> <th>UOM</th> </tr> </thead> <tbody> <tr> <td>0H7324A0</td> <td>ONE OVENS WASHING SYST HOLDING PLATE</td> <td>1</td> <td>PZ</td> </tr> <tr> <td>0H7819A0</td> <td>ONE WASHING SYS SUPPORT WITH STEAM VALVE</td> <td>1</td> <td>PZ</td> </tr> <tr> <td>EL1436A0</td> <td>H2O SOLENOID JG D8 CHECK VALVE</td> <td>1</td> <td>PZ</td> </tr> <tr> <td>GN1526A0</td> <td>INT. D.=6.9 TH=1.8 O-RIN</td> <td>1</td> <td>PZ</td> </tr> <tr> <td>RC1006A0</td> <td>D8 PET PIPE GUIDE BEND</td> <td>2</td> <td>PZ</td> </tr> <tr> <td>RC1019A0</td> <td>D=10 ELASTIC CLAMP</td> <td>15</td> <td>PZ</td> </tr> <tr> <td>RC1242A0</td> <td>D=10 CLOSED CAP</td> <td>2</td> <td>PZ</td> </tr> <tr> <td>RC1408A0</td> <td>DOUBLE WIRE SPRING CLAMP D10.8 ZN</td> <td>2</td> <td>PZ</td> </tr> <tr> <td>TB1818A0</td> <td>JG Ø8 BLUE PE PIPE</td> <td>0.320</td> <td>M</td> </tr> <tr> <td>TB2820A0</td> <td>PIPE EPDM FOR WASHING SYSTEM</td> <td>1.380</td> <td>M</td> </tr> <tr> <td>VH1220A1</td> <td>4,2X12 TCB SELF-TAPPIN G SCREW</td> <td>1</td> <td>PZ</td> </tr> <tr> <td>VL1019A0</td> <td>VIBRATION PUMP</td> <td>1</td> <td>PZ</td> </tr> <tr> <td>VL1053B0</td> <td>ONE WASHING SYS EXT DISTRIBUTOR</td> <td>1</td> <td>PZ</td> </tr> <tr> <td>VL1054B0</td> <td>ONE WASHING SYS INLET DISTRIBUTOR</td> <td>1</td> <td>PZ</td> </tr> <tr> <td>VL1080A0</td> <td>DETERGENT FILTER</td> <td>1</td> <td>PZ</td> </tr> <tr> <td>VL1081A0</td> <td>D6 BARBED NO RETURN VALVE</td> <td>1</td> <td>PZ</td> </tr> <tr> <td>VL1102A0</td> <td></td> <td>1</td> <td>PZ</td> </tr> <tr> <td>VL1102A1</td> <td>DETERGENT LINE FILTER + BARBED VNR 6 MM</td> <td>1</td> <td>PZ</td> </tr> </tbody> </table>	Code	Description	Qty	UOM	0H7324A0	ONE OVENS WASHING SYST HOLDING PLATE	1	PZ	0H7819A0	ONE WASHING SYS SUPPORT WITH STEAM VALVE	1	PZ	EL1436A0	H2O SOLENOID JG D8 CHECK VALVE	1	PZ	GN1526A0	INT. D.=6.9 TH=1.8 O-RIN	1	PZ	RC1006A0	D8 PET PIPE GUIDE BEND	2	PZ	RC1019A0	D=10 ELASTIC CLAMP	15	PZ	RC1242A0	D=10 CLOSED CAP	2	PZ	RC1408A0	DOUBLE WIRE SPRING CLAMP D10.8 ZN	2	PZ	TB1818A0	JG Ø8 BLUE PE PIPE	0.320	M	TB2820A0	PIPE EPDM FOR WASHING SYSTEM	1.380	M	VH1220A1	4,2X12 TCB SELF-TAPPIN G SCREW	1	PZ	VL1019A0	VIBRATION PUMP	1	PZ	VL1053B0	ONE WASHING SYS EXT DISTRIBUTOR	1	PZ	VL1054B0	ONE WASHING SYS INLET DISTRIBUTOR	1	PZ	VL1080A0	DETERGENT FILTER	1	PZ	VL1081A0	D6 BARBED NO RETURN VALVE	1	PZ	VL1102A0		1	PZ	VL1102A1	DETERGENT LINE FILTER + BARBED VNR 6 MM	1	PZ
Code	Description	Qty	UOM																																																																														
0H7324A0	ONE OVENS WASHING SYST HOLDING PLATE	1	PZ																																																																														
0H7819A0	ONE WASHING SYS SUPPORT WITH STEAM VALVE	1	PZ																																																																														
EL1436A0	H2O SOLENOID JG D8 CHECK VALVE	1	PZ																																																																														
GN1526A0	INT. D.=6.9 TH=1.8 O-RIN	1	PZ																																																																														
RC1006A0	D8 PET PIPE GUIDE BEND	2	PZ																																																																														
RC1019A0	D=10 ELASTIC CLAMP	15	PZ																																																																														
RC1242A0	D=10 CLOSED CAP	2	PZ																																																																														
RC1408A0	DOUBLE WIRE SPRING CLAMP D10.8 ZN	2	PZ																																																																														
TB1818A0	JG Ø8 BLUE PE PIPE	0.320	M																																																																														
TB2820A0	PIPE EPDM FOR WASHING SYSTEM	1.380	M																																																																														
VH1220A1	4,2X12 TCB SELF-TAPPIN G SCREW	1	PZ																																																																														
VL1019A0	VIBRATION PUMP	1	PZ																																																																														
VL1053B0	ONE WASHING SYS EXT DISTRIBUTOR	1	PZ																																																																														
VL1054B0	ONE WASHING SYS INLET DISTRIBUTOR	1	PZ																																																																														
VL1080A0	DETERGENT FILTER	1	PZ																																																																														
VL1081A0	D6 BARBED NO RETURN VALVE	1	PZ																																																																														
VL1102A0		1	PZ																																																																														
VL1102A1	DETERGENT LINE FILTER + BARBED VNR 6 MM	1	PZ																																																																														

COMPONENT			SPARE PART																						
Code	Description	Image	Code	Description	Components list																				
VL1106B			KVL1106A	EUR 1 ROTOR ARM ONE CLEANING SYSTEM KIT	<table border="1"> <thead> <tr> <th>Code</th> <th>Description</th> <th>Qty</th> <th>UOM</th> </tr> </thead> <tbody> <tr> <td>VL1128A0</td> <td>BARBED CHECK VALVE D6</td> <td>1</td> <td>PZ</td> </tr> <tr> <td>VM2172A0</td> <td>PUMP LOCKING CLIP</td> <td>1</td> <td>PZ</td> </tr> </tbody> </table>	Code	Description	Qty	UOM	VL1128A0	BARBED CHECK VALVE D6	1	PZ	VM2172A0	PUMP LOCKING CLIP	1	PZ								
Code	Description	Qty	UOM																						
VL1128A0	BARBED CHECK VALVE D6	1	PZ																						
VM2172A0	PUMP LOCKING CLIP	1	PZ																						
RC1019A	D=10 ELASTIC CLAM		KRC1019A	Ø10 ZINC PLATED ELASTIC CLAMP 15 PCS KIT	<table border="1"> <thead> <tr> <th>Code</th> <th>Description</th> <th>Qty</th> <th>UOM</th> </tr> </thead> <tbody> <tr> <td>RC1019A0</td> <td>D=10 ELASTIC CLAMP</td> <td>15</td> <td>PZ</td> </tr> </tbody> </table>	Code	Description	Qty	UOM	RC1019A0	D=10 ELASTIC CLAMP	15	PZ												
Code	Description	Qty	UOM																						
RC1019A0	D=10 ELASTIC CLAMP	15	PZ																						
TB3007A	TB2820A-DETERGENT ONE COIL		KTB3007A	MIND.MAPS ONE DETERGENT PIPE COIL KIT	<table border="1"> <thead> <tr> <th>Code</th> <th>Description</th> <th>Qty</th> <th>UOM</th> </tr> </thead> <tbody> <tr> <td>TB2820A0</td> <td>PIPE EPDM FOR WASHING SYSTEM</td> <td>0.550</td> <td>M</td> </tr> </tbody> </table>	Code	Description	Qty	UOM	TB2820A0	PIPE EPDM FOR WASHING SYSTEM	0.550	M												
Code	Description	Qty	UOM																						
TB2820A0	PIPE EPDM FOR WASHING SYSTEM	0.550	M																						
TB3225B	TB2820A-TANK-WASHING SYS CONNECTION		TB3225B0	TB2820A-TANK-WASHING SYS CONNECTION																					
VL1102A			KVL1102A	DETERGENT FILTER + NRV KIT	<table border="1"> <thead> <tr> <th>Code</th> <th>Description</th> <th>Qty</th> <th>UOM</th> </tr> </thead> <tbody> <tr> <td>RC1019A0</td> <td>D=10 ELASTIC CLAMP</td> <td>3</td> <td>PZ</td> </tr> <tr> <td>TB2820A0</td> <td>PIPE EPDM FOR WASHING SYSTEM</td> <td>0.110</td> <td>M</td> </tr> <tr> <td>VL1102A0</td> <td></td> <td>1</td> <td>PZ</td> </tr> <tr> <td>VL1102A1</td> <td>DETERGENT LINE FILTER + BARBED VNR 6 MM</td> <td>1</td> <td>PZ</td> </tr> </tbody> </table>	Code	Description	Qty	UOM	RC1019A0	D=10 ELASTIC CLAMP	3	PZ	TB2820A0	PIPE EPDM FOR WASHING SYSTEM	0.110	M	VL1102A0		1	PZ	VL1102A1	DETERGENT LINE FILTER + BARBED VNR 6 MM	1	PZ
Code	Description	Qty	UOM																						
RC1019A0	D=10 ELASTIC CLAMP	3	PZ																						
TB2820A0	PIPE EPDM FOR WASHING SYSTEM	0.110	M																						
VL1102A0		1	PZ																						
VL1102A1	DETERGENT LINE FILTER + BARBED VNR 6 MM	1	PZ																						



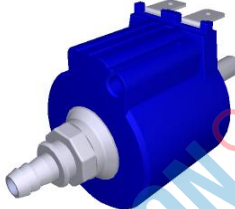

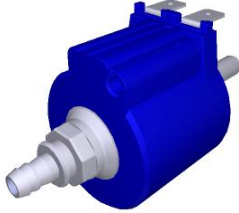
COMPONENT			SPARE PART																																																														
Code	Description	Image	Code	Description	Components list																																																												
VL1047A	HOSE D6 TANG D8																																																																
VL1019A	VIBRATION PUMP		KVL1121A	EUR MIND.MAPS HOOD CLEANING SYSTEM KIT	<table border="1"> <thead> <tr> <th>Code</th> <th>Description</th> <th>Qty</th> <th>UOM</th> </tr> </thead> <tbody> <tr> <td>0H7368A0</td> <td>S6 HOOD WATER SYSTEM PLAT</td> <td>1</td> <td>PZ</td> </tr> <tr> <td>EL1424A0</td> <td>D8 CONNECTION WATER SOLENOID VALVE</td> <td>1</td> <td>PZ</td> </tr> <tr> <td>EL1436A0</td> <td>H2O SOLENOID JG D8 CHECK VALVE</td> <td>1</td> <td>PZ</td> </tr> <tr> <td>GN1526A0</td> <td>INT. D.=6.9 TH=1.8 O-RIN</td> <td>1</td> <td>PZ</td> </tr> <tr> <td>RC1018A0</td> <td>ZINC PLATED D12 ELASTIC CLAMP</td> <td>4</td> <td>PZ</td> </tr> <tr> <td>RC1019A0</td> <td>D=10 ELASTIC CLAMP</td> <td>12</td> <td>PZ</td> </tr> <tr> <td>RC1242A0</td> <td>D=10 CLOSED CAP</td> <td>2</td> <td>PZ</td> </tr> <tr> <td>RC1408A0</td> <td>DOUBLE WIRE SPRING CLAMP D10.8 ZN</td> <td>2</td> <td>PZ</td> </tr> <tr> <td>TB2820A0</td> <td>PIPE EPDM FOR WASHING SYSTEM</td> <td>2.200</td> <td>M</td> </tr> <tr> <td>TB3132A0</td> <td>WHITE-BLUE EPDM TEXTILE BRAID HOSE 6X12</td> <td>0.540</td> <td>M</td> </tr> <tr> <td>VI1220A1</td> <td>4,2X12 TCB SELF-TAPPIN G SCREW</td> <td>5</td> <td>PZ</td> </tr> <tr> <td>VL1019A0</td> <td>VIBRATION PUMP</td> <td>1</td> <td>PZ</td> </tr> <tr> <td>VL1047A1</td> <td>D6 PIPE HOLDER - D8 J.G. TERMINAL</td> <td>2</td> <td>PZ</td> </tr> <tr> <td>VL1053B0</td> <td>ONE WASHING SYS EXT DISTRIBUTOR</td> <td>1</td> <td>PZ</td> </tr> </tbody> </table>	Code	Description	Qty	UOM	0H7368A0	S6 HOOD WATER SYSTEM PLAT	1	PZ	EL1424A0	D8 CONNECTION WATER SOLENOID VALVE	1	PZ	EL1436A0	H2O SOLENOID JG D8 CHECK VALVE	1	PZ	GN1526A0	INT. D.=6.9 TH=1.8 O-RIN	1	PZ	RC1018A0	ZINC PLATED D12 ELASTIC CLAMP	4	PZ	RC1019A0	D=10 ELASTIC CLAMP	12	PZ	RC1242A0	D=10 CLOSED CAP	2	PZ	RC1408A0	DOUBLE WIRE SPRING CLAMP D10.8 ZN	2	PZ	TB2820A0	PIPE EPDM FOR WASHING SYSTEM	2.200	M	TB3132A0	WHITE-BLUE EPDM TEXTILE BRAID HOSE 6X12	0.540	M	VI1220A1	4,2X12 TCB SELF-TAPPIN G SCREW	5	PZ	VL1019A0	VIBRATION PUMP	1	PZ	VL1047A1	D6 PIPE HOLDER - D8 J.G. TERMINAL	2	PZ	VL1053B0	ONE WASHING SYS EXT DISTRIBUTOR	1	PZ
Code	Description	Qty	UOM																																																														
0H7368A0	S6 HOOD WATER SYSTEM PLAT	1	PZ																																																														
EL1424A0	D8 CONNECTION WATER SOLENOID VALVE	1	PZ																																																														
EL1436A0	H2O SOLENOID JG D8 CHECK VALVE	1	PZ																																																														
GN1526A0	INT. D.=6.9 TH=1.8 O-RIN	1	PZ																																																														
RC1018A0	ZINC PLATED D12 ELASTIC CLAMP	4	PZ																																																														
RC1019A0	D=10 ELASTIC CLAMP	12	PZ																																																														
RC1242A0	D=10 CLOSED CAP	2	PZ																																																														
RC1408A0	DOUBLE WIRE SPRING CLAMP D10.8 ZN	2	PZ																																																														
TB2820A0	PIPE EPDM FOR WASHING SYSTEM	2.200	M																																																														
TB3132A0	WHITE-BLUE EPDM TEXTILE BRAID HOSE 6X12	0.540	M																																																														
VI1220A1	4,2X12 TCB SELF-TAPPIN G SCREW	5	PZ																																																														
VL1019A0	VIBRATION PUMP	1	PZ																																																														
VL1047A1	D6 PIPE HOLDER - D8 J.G. TERMINAL	2	PZ																																																														
VL1053B0	ONE WASHING SYS EXT DISTRIBUTOR	1	PZ																																																														

COMPONENT			SPARE PART																																						
Code	Description	Image	Code	Description	Components list																																				
VL1019A	VIBRATION PUMP		KVL1121A	EUR MIND.MAPS HOOD CLEANING SYSTEM KIT	<table border="1"> <thead> <tr> <th>Code</th> <th>Description</th> <th>Qty</th> <th>UOM</th> </tr> </thead> <tbody> <tr> <td>VL1054B0</td> <td>ONE WASHING SYS INLET DISTRIBUTOR</td> <td>1</td> <td>PZ</td> </tr> <tr> <td>VL1102A1</td> <td>DETERGENT LINE FILTER + BARBED VNR 6 MM</td> <td>1</td> <td>PZ</td> </tr> <tr> <td>VL1127A0</td> <td>T SHAPED BARBED FITTING D=6</td> <td>1</td> <td>PZ</td> </tr> <tr> <td>VL1127A1</td> <td>6MM BARBED T-SHAPED FITTING</td> <td>1</td> <td>PZ</td> </tr> <tr> <td>VL1128A0</td> <td>BARBED CHECK VALVE D6</td> <td>1</td> <td>PZ</td> </tr> <tr> <td>VM1605A0</td> <td>CLIP TWIST LOCK DIAM. 10,2-12,7 MM</td> <td>2</td> <td>PZ</td> </tr> <tr> <td>VM1610A0</td> <td>CLIP TWIST LOCK DIAM. 7,6-10,2 MM</td> <td>2</td> <td>PZ</td> </tr> <tr> <td>VM2172A0</td> <td>PUMP LOCKING CLIP</td> <td>1</td> <td>PZ</td> </tr> </tbody> </table>	Code	Description	Qty	UOM	VL1054B0	ONE WASHING SYS INLET DISTRIBUTOR	1	PZ	VL1102A1	DETERGENT LINE FILTER + BARBED VNR 6 MM	1	PZ	VL1127A0	T SHAPED BARBED FITTING D=6	1	PZ	VL1127A1	6MM BARBED T-SHAPED FITTING	1	PZ	VL1128A0	BARBED CHECK VALVE D6	1	PZ	VM1605A0	CLIP TWIST LOCK DIAM. 10,2-12,7 MM	2	PZ	VM1610A0	CLIP TWIST LOCK DIAM. 7,6-10,2 MM	2	PZ	VM2172A0	PUMP LOCKING CLIP	1	PZ
			Code	Description	Qty	UOM																																			
VL1054B0	ONE WASHING SYS INLET DISTRIBUTOR	1	PZ																																						
VL1102A1	DETERGENT LINE FILTER + BARBED VNR 6 MM	1	PZ																																						
VL1127A0	T SHAPED BARBED FITTING D=6	1	PZ																																						
VL1127A1	6MM BARBED T-SHAPED FITTING	1	PZ																																						
VL1128A0	BARBED CHECK VALVE D6	1	PZ																																						
VM1605A0	CLIP TWIST LOCK DIAM. 10,2-12,7 MM	2	PZ																																						
VM1610A0	CLIP TWIST LOCK DIAM. 7,6-10,2 MM	2	PZ																																						
VM2172A0	PUMP LOCKING CLIP	1	PZ																																						
KVL1120A	USA COMPACT PLUS CLEANING SYSTEM KIT	<table border="1"> <thead> <tr> <th>Code</th> <th>Description</th> <th>Qty</th> <th>UOM</th> </tr> </thead> <tbody> <tr> <td>0H7553D0</td> <td>XECC PLUS WASHING SYSTEM PLAT</td> <td>1</td> <td>PZ</td> </tr> <tr> <td>EL1422A1</td> <td>1 WAY SOLENOID VALVE + D8-D10 REDUCTION</td> <td>1</td> <td>PZ</td> </tr> <tr> <td>EL1426A0</td> <td>H2O UL SOLENOID JG D8-PIPE HOLDER</td> <td>1</td> <td>PZ</td> </tr> <tr> <td>EL1437A0</td> <td>H2O SOLENOID JG D6 UL CHECK VALVE</td> <td>1</td> <td>PZ</td> </tr> <tr> <td>GN1312A0</td> <td>RUBBER CABLE-PASSI NG DE=26 DI=15 SP=10</td> <td>1</td> <td>PZ</td> </tr> <tr> <td>GN1526A0</td> <td>INT. D.=6.9 TH=1.8 O-RIN</td> <td>1</td> <td>PZ</td> </tr> <tr> <td>RC1019A0</td> <td>D=10 ELASTIC CLAMP</td> <td>8</td> <td>PZ</td> </tr> <tr> <td>RC1242A0</td> <td>D=10 CLOSED CAP</td> <td>2</td> <td>PZ</td> </tr> </tbody> </table>	Code	Description	Qty	UOM	0H7553D0	XECC PLUS WASHING SYSTEM PLAT	1	PZ	EL1422A1	1 WAY SOLENOID VALVE + D8-D10 REDUCTION	1	PZ	EL1426A0	H2O UL SOLENOID JG D8-PIPE HOLDER	1	PZ	EL1437A0	H2O SOLENOID JG D6 UL CHECK VALVE	1	PZ	GN1312A0	RUBBER CABLE-PASSI NG DE=26 DI=15 SP=10	1	PZ	GN1526A0	INT. D.=6.9 TH=1.8 O-RIN	1	PZ	RC1019A0	D=10 ELASTIC CLAMP	8	PZ	RC1242A0	D=10 CLOSED CAP	2	PZ			
Code	Description	Qty	UOM																																						
0H7553D0	XECC PLUS WASHING SYSTEM PLAT	1	PZ																																						
EL1422A1	1 WAY SOLENOID VALVE + D8-D10 REDUCTION	1	PZ																																						
EL1426A0	H2O UL SOLENOID JG D8-PIPE HOLDER	1	PZ																																						
EL1437A0	H2O SOLENOID JG D6 UL CHECK VALVE	1	PZ																																						
GN1312A0	RUBBER CABLE-PASSI NG DE=26 DI=15 SP=10	1	PZ																																						
GN1526A0	INT. D.=6.9 TH=1.8 O-RIN	1	PZ																																						
RC1019A0	D=10 ELASTIC CLAMP	8	PZ																																						
RC1242A0	D=10 CLOSED CAP	2	PZ																																						

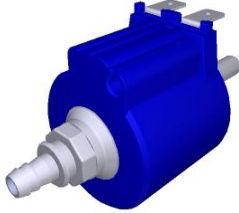

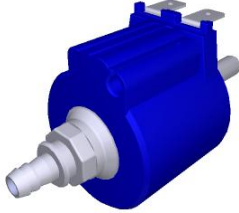
COMPONENT			SPARE PART																																																										
Code	Description	Image	Code	Description	Components list																																																								
VL1019A	VIBRATION PUMP		KVL1120A	USA COMPACT PLUS CLEANING SYSTEM KIT	<table border="1"> <thead> <tr> <th>Code</th> <th>Description</th> <th>Qty</th> <th>UOM</th> </tr> </thead> <tbody> <tr> <td>RC1356A0</td> <td>STRAIGHT THREADED FEMALE END 8X1/4" BSP</td> <td>1</td> <td>PZ</td> </tr> <tr> <td>RC1408A0</td> <td>DOUBLE WIRE SPRING CLAMP D10.8 ZN</td> <td>2</td> <td>PZ</td> </tr> <tr> <td>TB2820A0</td> <td>PIPE EPDM FOR WASHING SYSTEM</td> <td>1.200</td> <td>M</td> </tr> <tr> <td>VI1220A1</td> <td>4,2X12 TCB SELF-TAPPIN G SCREW</td> <td>9</td> <td>PZ</td> </tr> <tr> <td>VL1019A0</td> <td>VIBRATION PUMP</td> <td>1</td> <td>PZ</td> </tr> <tr> <td>VL1054B0</td> <td>ONE WASHING SYS INLET DISTRIBUTOR</td> <td>1</td> <td>PZ</td> </tr> <tr> <td>VL1064A0</td> <td>WASHING SYSTEM OUTLETS DISTRIBUTOR</td> <td>1</td> <td>PZ</td> </tr> <tr> <td>VL1065A1</td> <td>1/4 MALE N.O. PRESSURE SWITCH</td> <td>1</td> <td>PZ</td> </tr> <tr> <td>VL1081A0</td> <td>D6 BARBED NO RETURN VALVE</td> <td>1</td> <td>PZ</td> </tr> <tr> <td>VL1102A0</td> <td></td> <td>1</td> <td>PZ</td> </tr> <tr> <td>VL1102A1</td> <td>DETERGENT LINE FILTER + BARBED VNR 6 MM</td> <td>1</td> <td>PZ</td> </tr> <tr> <td>VL1128A0</td> <td>BARBED CHECK VALVE D6</td> <td>1</td> <td>PZ</td> </tr> <tr> <td>VM2172A0</td> <td>PUMP LOCKING CLIP</td> <td>1</td> <td>PZ</td> </tr> </tbody> </table>	Code	Description	Qty	UOM	RC1356A0	STRAIGHT THREADED FEMALE END 8X1/4" BSP	1	PZ	RC1408A0	DOUBLE WIRE SPRING CLAMP D10.8 ZN	2	PZ	TB2820A0	PIPE EPDM FOR WASHING SYSTEM	1.200	M	VI1220A1	4,2X12 TCB SELF-TAPPIN G SCREW	9	PZ	VL1019A0	VIBRATION PUMP	1	PZ	VL1054B0	ONE WASHING SYS INLET DISTRIBUTOR	1	PZ	VL1064A0	WASHING SYSTEM OUTLETS DISTRIBUTOR	1	PZ	VL1065A1	1/4 MALE N.O. PRESSURE SWITCH	1	PZ	VL1081A0	D6 BARBED NO RETURN VALVE	1	PZ	VL1102A0		1	PZ	VL1102A1	DETERGENT LINE FILTER + BARBED VNR 6 MM	1	PZ	VL1128A0	BARBED CHECK VALVE D6	1	PZ	VM2172A0	PUMP LOCKING CLIP	1	PZ
Code	Description	Qty	UOM																																																										
RC1356A0	STRAIGHT THREADED FEMALE END 8X1/4" BSP	1	PZ																																																										
RC1408A0	DOUBLE WIRE SPRING CLAMP D10.8 ZN	2	PZ																																																										
TB2820A0	PIPE EPDM FOR WASHING SYSTEM	1.200	M																																																										
VI1220A1	4,2X12 TCB SELF-TAPPIN G SCREW	9	PZ																																																										
VL1019A0	VIBRATION PUMP	1	PZ																																																										
VL1054B0	ONE WASHING SYS INLET DISTRIBUTOR	1	PZ																																																										
VL1064A0	WASHING SYSTEM OUTLETS DISTRIBUTOR	1	PZ																																																										
VL1065A1	1/4 MALE N.O. PRESSURE SWITCH	1	PZ																																																										
VL1081A0	D6 BARBED NO RETURN VALVE	1	PZ																																																										
VL1102A0		1	PZ																																																										
VL1102A1	DETERGENT LINE FILTER + BARBED VNR 6 MM	1	PZ																																																										
VL1128A0	BARBED CHECK VALVE D6	1	PZ																																																										
VM2172A0	PUMP LOCKING CLIP	1	PZ																																																										
			KVL1119A	EUR COMPACT PLUS CLEANING SYSTEM KIT	<table border="1"> <thead> <tr> <th>Code</th> <th>Description</th> <th>Qty</th> <th>UOM</th> </tr> </thead> <tbody> <tr> <td>0H7553C0</td> <td>XECC PLUS WASHING SYSTEM PLAT</td> <td>1</td> <td>PZ</td> </tr> <tr> <td>0H7553D0</td> <td>XECC PLUS WASHING SYSTEM PLAT</td> <td>1</td> <td>PZ</td> </tr> <tr> <td>EL1252A1</td> <td>1 WAY WATER VALVE + J.G. CONNECTION</td> <td>1</td> <td>PZ</td> </tr> </tbody> </table>	Code	Description	Qty	UOM	0H7553C0	XECC PLUS WASHING SYSTEM PLAT	1	PZ	0H7553D0	XECC PLUS WASHING SYSTEM PLAT	1	PZ	EL1252A1	1 WAY WATER VALVE + J.G. CONNECTION	1	PZ																																								
Code	Description	Qty	UOM																																																										
0H7553C0	XECC PLUS WASHING SYSTEM PLAT	1	PZ																																																										
0H7553D0	XECC PLUS WASHING SYSTEM PLAT	1	PZ																																																										
EL1252A1	1 WAY WATER VALVE + J.G. CONNECTION	1	PZ																																																										

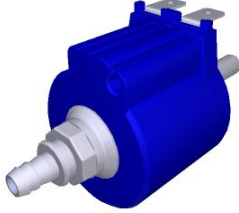
COMPONENT			SPARE PART																																																																										
Code	Description	Image	Code	Description	Components list																																																																								
VL1019A	VIBRATION PUMP		KVL1119A	EUR COMPACT PLUS CLEANING SYSTEM KIT	<table border="1"> <thead> <tr> <th>Code</th> <th>Description</th> <th>Qty</th> <th>UOM</th> </tr> </thead> <tbody> <tr> <td>EL1424A0</td> <td>D8 CONNECTION WATER SOLENOID VALVE</td> <td>1</td> <td>PZ</td> </tr> <tr> <td>EL1436A0</td> <td>H2O SOLENOID JG D8 CHECK VALVE</td> <td>1</td> <td>PZ</td> </tr> <tr> <td>GN1312A0</td> <td>RUBBER CABLE-PASSI NG DE=26 DI=15 SP=10</td> <td>1</td> <td>PZ</td> </tr> <tr> <td>GN1526A0</td> <td>INT. D.=6.9 TH=1.8 O-RING</td> <td>1</td> <td>PZ</td> </tr> <tr> <td>RC1006A0</td> <td>D8 PET PIPE GUIDE BEND</td> <td>2</td> <td>PZ</td> </tr> <tr> <td>RC1019A0</td> <td>D=10 ELASTIC CLAMP</td> <td>9</td> <td>PZ</td> </tr> <tr> <td>RC1242A0</td> <td>D=10 CLOSED CAP</td> <td>2</td> <td>PZ</td> </tr> <tr> <td>RC1356A0</td> <td>STRAIGHT THREADED FEMALE END 8X1/4" BSP</td> <td>1</td> <td>PZ</td> </tr> <tr> <td>RC1408A0</td> <td>DOUBLE WIRE SPRING CLAMP D10.8 ZN</td> <td>2</td> <td>PZ</td> </tr> <tr> <td>TB1818A0</td> <td>JG Ø8 BLUE PE PIPE</td> <td>0.680</td> <td>M</td> </tr> <tr> <td>TB2820A0</td> <td>PIPE EPDM FOR WASHING SYSTEM</td> <td>1.700</td> <td>M</td> </tr> <tr> <td>VH1220A1</td> <td>4,2X12 TCB SELF-TAPPING SCREW</td> <td>10</td> <td>PZ</td> </tr> <tr> <td>VL1019A0</td> <td>VIBRATION PUMP</td> <td>1</td> <td>PZ</td> </tr> <tr> <td>VL1054B0</td> <td>ONE WASHING SYS INLET DISTRIBUTOR</td> <td>1</td> <td>PZ</td> </tr> <tr> <td>VL1064A0</td> <td>WASHING SYSTEM OUTLETS DISTRIBUTOR</td> <td>1</td> <td>PZ</td> </tr> <tr> <td>VL1065A1</td> <td>1/4 MALE N.O. PRESSURE SWITCH</td> <td>1</td> <td>PZ</td> </tr> <tr> <td>VL1081A0</td> <td>D6 BARBED NO RETURN VALVE</td> <td>1</td> <td>PZ</td> </tr> </tbody> </table>	Code	Description	Qty	UOM	EL1424A0	D8 CONNECTION WATER SOLENOID VALVE	1	PZ	EL1436A0	H2O SOLENOID JG D8 CHECK VALVE	1	PZ	GN1312A0	RUBBER CABLE-PASSI NG DE=26 DI=15 SP=10	1	PZ	GN1526A0	INT. D.=6.9 TH=1.8 O-RING	1	PZ	RC1006A0	D8 PET PIPE GUIDE BEND	2	PZ	RC1019A0	D=10 ELASTIC CLAMP	9	PZ	RC1242A0	D=10 CLOSED CAP	2	PZ	RC1356A0	STRAIGHT THREADED FEMALE END 8X1/4" BSP	1	PZ	RC1408A0	DOUBLE WIRE SPRING CLAMP D10.8 ZN	2	PZ	TB1818A0	JG Ø8 BLUE PE PIPE	0.680	M	TB2820A0	PIPE EPDM FOR WASHING SYSTEM	1.700	M	VH1220A1	4,2X12 TCB SELF-TAPPING SCREW	10	PZ	VL1019A0	VIBRATION PUMP	1	PZ	VL1054B0	ONE WASHING SYS INLET DISTRIBUTOR	1	PZ	VL1064A0	WASHING SYSTEM OUTLETS DISTRIBUTOR	1	PZ	VL1065A1	1/4 MALE N.O. PRESSURE SWITCH	1	PZ	VL1081A0	D6 BARBED NO RETURN VALVE	1	PZ
Code	Description	Qty	UOM																																																																										
EL1424A0	D8 CONNECTION WATER SOLENOID VALVE	1	PZ																																																																										
EL1436A0	H2O SOLENOID JG D8 CHECK VALVE	1	PZ																																																																										
GN1312A0	RUBBER CABLE-PASSI NG DE=26 DI=15 SP=10	1	PZ																																																																										
GN1526A0	INT. D.=6.9 TH=1.8 O-RING	1	PZ																																																																										
RC1006A0	D8 PET PIPE GUIDE BEND	2	PZ																																																																										
RC1019A0	D=10 ELASTIC CLAMP	9	PZ																																																																										
RC1242A0	D=10 CLOSED CAP	2	PZ																																																																										
RC1356A0	STRAIGHT THREADED FEMALE END 8X1/4" BSP	1	PZ																																																																										
RC1408A0	DOUBLE WIRE SPRING CLAMP D10.8 ZN	2	PZ																																																																										
TB1818A0	JG Ø8 BLUE PE PIPE	0.680	M																																																																										
TB2820A0	PIPE EPDM FOR WASHING SYSTEM	1.700	M																																																																										
VH1220A1	4,2X12 TCB SELF-TAPPING SCREW	10	PZ																																																																										
VL1019A0	VIBRATION PUMP	1	PZ																																																																										
VL1054B0	ONE WASHING SYS INLET DISTRIBUTOR	1	PZ																																																																										
VL1064A0	WASHING SYSTEM OUTLETS DISTRIBUTOR	1	PZ																																																																										
VL1065A1	1/4 MALE N.O. PRESSURE SWITCH	1	PZ																																																																										
VL1081A0	D6 BARBED NO RETURN VALVE	1	PZ																																																																										

COMPONENT			SPARE PART																																																										
Code	Description	Image	Code	Description	Components list																																																								
VL1019A	VIBRATION PUMP		KVL1119A	EUR COMPACT PLUS CLEANING SYSTEM KIT	<table border="1"> <thead> <tr> <th>Code</th> <th>Description</th> <th>Qty</th> <th>UOM</th> </tr> </thead> <tbody> <tr> <td>VL1083A0</td> <td>D=10 CONNECTION - D=6 PIPE FITTING</td> <td>1</td> <td>PZ</td> </tr> <tr> <td>VL1102A0</td> <td></td> <td>1</td> <td>PZ</td> </tr> <tr> <td>VL1102A1</td> <td>DETERGENT LINE FILTER + BARBED VNR 6 MM</td> <td>1</td> <td>PZ</td> </tr> <tr> <td>VL1128A0</td> <td>BARBED CHECK VALVE D6</td> <td>1</td> <td>PZ</td> </tr> <tr> <td>VM1610A0</td> <td>CLIP TWIST LOCK DIAM. 7,6-10,2 MM</td> <td>3</td> <td>PZ</td> </tr> <tr> <td>VM2172A0</td> <td>PUMP LOCKING CLIP</td> <td>1</td> <td>PZ</td> </tr> </tbody> </table>	Code	Description	Qty	UOM	VL1083A0	D=10 CONNECTION - D=6 PIPE FITTING	1	PZ	VL1102A0		1	PZ	VL1102A1	DETERGENT LINE FILTER + BARBED VNR 6 MM	1	PZ	VL1128A0	BARBED CHECK VALVE D6	1	PZ	VM1610A0	CLIP TWIST LOCK DIAM. 7,6-10,2 MM	3	PZ	VM2172A0	PUMP LOCKING CLIP	1	PZ																												
Code	Description	Qty	UOM																																																										
VL1083A0	D=10 CONNECTION - D=6 PIPE FITTING	1	PZ																																																										
VL1102A0		1	PZ																																																										
VL1102A1	DETERGENT LINE FILTER + BARBED VNR 6 MM	1	PZ																																																										
VL1128A0	BARBED CHECK VALVE D6	1	PZ																																																										
VM1610A0	CLIP TWIST LOCK DIAM. 7,6-10,2 MM	3	PZ																																																										
VM2172A0	PUMP LOCKING CLIP	1	PZ																																																										
			KVL1118A	EUR COMPACT ONE CLEANING SYSTEM KIT	<table border="1"> <thead> <tr> <th>Code</th> <th>Description</th> <th>Qty</th> <th>UOM</th> </tr> </thead> <tbody> <tr> <td>0H7173C0</td> <td>XECC ONE WASHING SYSTEM PLAT</td> <td>1</td> <td>PZ</td> </tr> <tr> <td>EL1436A0</td> <td>H2O SOLENOID JG D8 CHECK VALVE</td> <td>1</td> <td>PZ</td> </tr> <tr> <td>GN1526A0</td> <td>INT. D.=6.9 TH=1.8 O-RIN</td> <td>1</td> <td>PZ</td> </tr> <tr> <td>RC1019A0</td> <td>D=10 ELASTIC CLAMP</td> <td>10</td> <td>PZ</td> </tr> <tr> <td>RC1242A0</td> <td>D=10 CLOSED CAP</td> <td>2</td> <td>PZ</td> </tr> <tr> <td>RC1408A0</td> <td>DOUBLE WIRE SPRING CLAMP D10.8 ZN</td> <td>2</td> <td>PZ</td> </tr> <tr> <td>TB2820A0</td> <td>PIPE EPDM FOR WASHING SYSTEM</td> <td>1.200</td> <td>M</td> </tr> <tr> <td>VH1220A1</td> <td>4,2X12 TCB SELF-TAPPIN G SCREW</td> <td>6</td> <td>PZ</td> </tr> <tr> <td>VL1019A0</td> <td>VIBRATION PUMP</td> <td>1</td> <td>PZ</td> </tr> <tr> <td>VL1053B0</td> <td>ONE WASHING SYS EXT DISTRIBUTOR</td> <td>1</td> <td>PZ</td> </tr> <tr> <td>VL1054B0</td> <td>ONE WASHING SYS INLET DISTRIBUTOR</td> <td>1</td> <td>PZ</td> </tr> <tr> <td>VL1081A0</td> <td>D6 BARBED NO RETURN VALVE</td> <td>1</td> <td>PZ</td> </tr> <tr> <td>VL1102A0</td> <td></td> <td>1</td> <td>PZ</td> </tr> </tbody> </table>	Code	Description	Qty	UOM	0H7173C0	XECC ONE WASHING SYSTEM PLAT	1	PZ	EL1436A0	H2O SOLENOID JG D8 CHECK VALVE	1	PZ	GN1526A0	INT. D.=6.9 TH=1.8 O-RIN	1	PZ	RC1019A0	D=10 ELASTIC CLAMP	10	PZ	RC1242A0	D=10 CLOSED CAP	2	PZ	RC1408A0	DOUBLE WIRE SPRING CLAMP D10.8 ZN	2	PZ	TB2820A0	PIPE EPDM FOR WASHING SYSTEM	1.200	M	VH1220A1	4,2X12 TCB SELF-TAPPIN G SCREW	6	PZ	VL1019A0	VIBRATION PUMP	1	PZ	VL1053B0	ONE WASHING SYS EXT DISTRIBUTOR	1	PZ	VL1054B0	ONE WASHING SYS INLET DISTRIBUTOR	1	PZ	VL1081A0	D6 BARBED NO RETURN VALVE	1	PZ	VL1102A0		1	PZ
Code	Description	Qty	UOM																																																										
0H7173C0	XECC ONE WASHING SYSTEM PLAT	1	PZ																																																										
EL1436A0	H2O SOLENOID JG D8 CHECK VALVE	1	PZ																																																										
GN1526A0	INT. D.=6.9 TH=1.8 O-RIN	1	PZ																																																										
RC1019A0	D=10 ELASTIC CLAMP	10	PZ																																																										
RC1242A0	D=10 CLOSED CAP	2	PZ																																																										
RC1408A0	DOUBLE WIRE SPRING CLAMP D10.8 ZN	2	PZ																																																										
TB2820A0	PIPE EPDM FOR WASHING SYSTEM	1.200	M																																																										
VH1220A1	4,2X12 TCB SELF-TAPPIN G SCREW	6	PZ																																																										
VL1019A0	VIBRATION PUMP	1	PZ																																																										
VL1053B0	ONE WASHING SYS EXT DISTRIBUTOR	1	PZ																																																										
VL1054B0	ONE WASHING SYS INLET DISTRIBUTOR	1	PZ																																																										
VL1081A0	D6 BARBED NO RETURN VALVE	1	PZ																																																										
VL1102A0		1	PZ																																																										

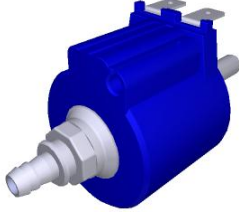
COMPONENT			SPARE PART																																																																			
Code	Description	Image	Code	Description	Components list																																																																	
VL1019A	VIBRATION PUMP		KVL1118A	EUR COMPACT ONE CLEANING SYSTEM KIT	<table border="1"> <thead> <tr> <th>Code</th> <th>Description</th> <th>Qty</th> <th>UOM</th> </tr> </thead> <tbody> <tr> <td>VL1102A1</td> <td>DETERGENT LINE FILTER + BARBED VNR 6 MM</td> <td>1</td> <td>PZ</td> </tr> <tr> <td>VL1128A0</td> <td>BARBED CHECK VALVE D6</td> <td>1</td> <td>PZ</td> </tr> <tr> <td>VM2172A0</td> <td>PUMP LOCKING CLIP</td> <td>1</td> <td>PZ</td> </tr> </tbody> </table>	Code	Description	Qty	UOM	VL1102A1	DETERGENT LINE FILTER + BARBED VNR 6 MM	1	PZ	VL1128A0	BARBED CHECK VALVE D6	1	PZ	VM2172A0	PUMP LOCKING CLIP	1	PZ																																																	
			Code	Description	Qty	UOM																																																																
VL1102A1	DETERGENT LINE FILTER + BARBED VNR 6 MM	1	PZ																																																																			
VL1128A0	BARBED CHECK VALVE D6	1	PZ																																																																			
VM2172A0	PUMP LOCKING CLIP	1	PZ																																																																			
KVL1109A	EUR 2 ROTOR ARMS ONE CLEANING SYSTEM KIT	<table border="1"> <thead> <tr> <th>Code</th> <th>Description</th> <th>Qty</th> <th>UOM</th> </tr> </thead> <tbody> <tr> <td>0H7324A0</td> <td>ONE OVENS WASHING SYST HOLDING PLATE</td> <td>2</td> <td>PZ</td> </tr> <tr> <td>0H7515A0</td> <td>XEVC-2011-E1 R DOUBLE WASHING SYS PLATE</td> <td>1</td> <td>PZ</td> </tr> <tr> <td>CH1000A0</td> <td>SNIP PIPE CUTTER</td> <td>1</td> <td>PZ</td> </tr> <tr> <td>EL1115A0</td> <td>Ø8 Y CONNECTION</td> <td>1</td> <td>PZ</td> </tr> <tr> <td>EL1436A0</td> <td>H2O SOLENOID JG D8 CHECK VALVE</td> <td>2</td> <td>PZ</td> </tr> <tr> <td>GN1526A0</td> <td>INT. D.=6.9 TH=1.8 O-RIN</td> <td>2</td> <td>PZ</td> </tr> <tr> <td>RC1006A0</td> <td>D8 PET PIPE GUIDE BEND</td> <td>4</td> <td>PZ</td> </tr> <tr> <td>RC1019A0</td> <td>D=10 ELASTIC CLAMP</td> <td>30</td> <td>PZ</td> </tr> <tr> <td>RC1242A0</td> <td>D=10 CLOSED CAP</td> <td>4</td> <td>PZ</td> </tr> <tr> <td>TB1818A0</td> <td>JG Ø8 BLUE PE PIPE</td> <td>1.640</td> <td>M</td> </tr> <tr> <td>TB2820A0</td> <td>PIPE EPDM FOR WASHING SYSTEM</td> <td>2.760</td> <td>M</td> </tr> <tr> <td>VI1220A1</td> <td>4,2X12 TCB SELF-TAPPIN G SCREW</td> <td>8</td> <td>PZ</td> </tr> <tr> <td>VL1019A0</td> <td>VIBRATION PUMP</td> <td>2</td> <td>PZ</td> </tr> <tr> <td>VL1053B0</td> <td>ONE WASHING SYS EXT DISTRIBUTOR</td> <td>2</td> <td>PZ</td> </tr> <tr> <td>VL1054B0</td> <td>ONE WASHING SYS INLET DISTRIBUTOR</td> <td>2</td> <td>PZ</td> </tr> <tr> <td>VL1080A0</td> <td>DETERGENT FILTER</td> <td>2</td> <td>PZ</td> </tr> </tbody> </table>	Code	Description	Qty	UOM	0H7324A0	ONE OVENS WASHING SYST HOLDING PLATE	2	PZ	0H7515A0	XEVC-2011-E1 R DOUBLE WASHING SYS PLATE	1	PZ	CH1000A0	SNIP PIPE CUTTER	1	PZ	EL1115A0	Ø8 Y CONNECTION	1	PZ	EL1436A0	H2O SOLENOID JG D8 CHECK VALVE	2	PZ	GN1526A0	INT. D.=6.9 TH=1.8 O-RIN	2	PZ	RC1006A0	D8 PET PIPE GUIDE BEND	4	PZ	RC1019A0	D=10 ELASTIC CLAMP	30	PZ	RC1242A0	D=10 CLOSED CAP	4	PZ	TB1818A0	JG Ø8 BLUE PE PIPE	1.640	M	TB2820A0	PIPE EPDM FOR WASHING SYSTEM	2.760	M	VI1220A1	4,2X12 TCB SELF-TAPPIN G SCREW	8	PZ	VL1019A0	VIBRATION PUMP	2	PZ	VL1053B0	ONE WASHING SYS EXT DISTRIBUTOR	2	PZ	VL1054B0	ONE WASHING SYS INLET DISTRIBUTOR	2	PZ	VL1080A0	DETERGENT FILTER	2	PZ
Code	Description	Qty	UOM																																																																			
0H7324A0	ONE OVENS WASHING SYST HOLDING PLATE	2	PZ																																																																			
0H7515A0	XEVC-2011-E1 R DOUBLE WASHING SYS PLATE	1	PZ																																																																			
CH1000A0	SNIP PIPE CUTTER	1	PZ																																																																			
EL1115A0	Ø8 Y CONNECTION	1	PZ																																																																			
EL1436A0	H2O SOLENOID JG D8 CHECK VALVE	2	PZ																																																																			
GN1526A0	INT. D.=6.9 TH=1.8 O-RIN	2	PZ																																																																			
RC1006A0	D8 PET PIPE GUIDE BEND	4	PZ																																																																			
RC1019A0	D=10 ELASTIC CLAMP	30	PZ																																																																			
RC1242A0	D=10 CLOSED CAP	4	PZ																																																																			
TB1818A0	JG Ø8 BLUE PE PIPE	1.640	M																																																																			
TB2820A0	PIPE EPDM FOR WASHING SYSTEM	2.760	M																																																																			
VI1220A1	4,2X12 TCB SELF-TAPPIN G SCREW	8	PZ																																																																			
VL1019A0	VIBRATION PUMP	2	PZ																																																																			
VL1053B0	ONE WASHING SYS EXT DISTRIBUTOR	2	PZ																																																																			
VL1054B0	ONE WASHING SYS INLET DISTRIBUTOR	2	PZ																																																																			
VL1080A0	DETERGENT FILTER	2	PZ																																																																			

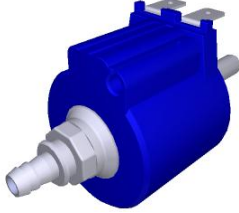
COMPONENT			SPARE PART																																																											
Code	Description	Image	Code	Description	Components list																																																									
VL1019A	VIBRATION PUMP		KVL1109A	EUR 2 ROTOR ARMS ONE CLEANING SYSTEM KIT	<table border="1"> <thead> <tr> <th>Code</th> <th>Description</th> <th>Qty</th> <th>UOM</th> </tr> </thead> <tbody> <tr> <td>VL1081A0</td> <td>D6 BARBED NO RETURN VALVE</td> <td>4</td> <td>PZ</td> </tr> <tr> <td>VL1102A0</td> <td></td> <td>2</td> <td>PZ</td> </tr> <tr> <td>VL1102A1</td> <td>DETERGENT LINE FILTER + BARBED VNR 6 MM</td> <td>2</td> <td>PZ</td> </tr> <tr> <td>VL1128A0</td> <td>BARBED CHECK VALVE D6</td> <td>2</td> <td>PZ</td> </tr> <tr> <td>VM2172A0</td> <td>PUMP LOCKING CLIP</td> <td>2</td> <td>PZ</td> </tr> </tbody> </table>	Code	Description	Qty	UOM	VL1081A0	D6 BARBED NO RETURN VALVE	4	PZ	VL1102A0		2	PZ	VL1102A1	DETERGENT LINE FILTER + BARBED VNR 6 MM	2	PZ	VL1128A0	BARBED CHECK VALVE D6	2	PZ	VM2172A0	PUMP LOCKING CLIP	2	PZ																																	
			Code	Description	Qty	UOM																																																								
VL1081A0	D6 BARBED NO RETURN VALVE	4	PZ																																																											
VL1102A0		2	PZ																																																											
VL1102A1	DETERGENT LINE FILTER + BARBED VNR 6 MM	2	PZ																																																											
VL1128A0	BARBED CHECK VALVE D6	2	PZ																																																											
VM2172A0	PUMP LOCKING CLIP	2	PZ																																																											
KVL1108A	04EU ONE EUR 1 ROTOR CLEANING SYSTEM KIT	<table border="1"> <thead> <tr> <th>Code</th> <th>Description</th> <th>Qty</th> <th>UOM</th> </tr> </thead> <tbody> <tr> <td>0H7323A0</td> <td>WASHING SYSTEM HOLDING PLATE</td> <td>1</td> <td>PZ</td> </tr> <tr> <td>0H7511A0</td> <td>ONE OVENS WASHING SYST HOLDING PLATE</td> <td>1</td> <td>PZ</td> </tr> <tr> <td>EL1252A1</td> <td>1 WAY WATER VALVE + J.G. CONNECTION</td> <td>1</td> <td>PZ</td> </tr> <tr> <td>EL1424A0</td> <td>D8 CONNECTION WATER SOLENOID VALVE</td> <td>1</td> <td>PZ</td> </tr> <tr> <td>EL1436A0</td> <td>H2O SOLENOID JG D8 CHECK VALVE</td> <td>1</td> <td>PZ</td> </tr> <tr> <td>GN1526A0</td> <td>INT. D.=6.9 TH=1.8 O-RING</td> <td>1</td> <td>PZ</td> </tr> <tr> <td>RC1006A0</td> <td>D8 PET PIPE GUIDE BEND</td> <td>2</td> <td>PZ</td> </tr> <tr> <td>RC1019A0</td> <td>D=10 ELASTIC CLAMP</td> <td>11</td> <td>PZ</td> </tr> <tr> <td>RC1130A0</td> <td>130X2,6 CLAM</td> <td>1</td> <td>PZ</td> </tr> <tr> <td>RC1242A0</td> <td>D=10 CLOSED CAP</td> <td>2</td> <td>PZ</td> </tr> <tr> <td>RC1310A0</td> <td>140X4 CLAMP WITH CLIP</td> <td>2</td> <td>PZ</td> </tr> <tr> <td>RC1356A0</td> <td>STRAIGHT THREADED FEMALE END 8X1/4" BSP</td> <td>1</td> <td>PZ</td> </tr> <tr> <td>TB1818A0</td> <td>JG Ø8 BLUE PE PIPE</td> <td>0.220</td> <td>M</td> </tr> <tr> <td>TB2820A0</td> <td>PIPE EPDM FOR WASHING SYSTEM</td> <td>1.240</td> <td>M</td> </tr> </tbody> </table>	Code	Description	Qty	UOM	0H7323A0	WASHING SYSTEM HOLDING PLATE	1	PZ	0H7511A0	ONE OVENS WASHING SYST HOLDING PLATE	1	PZ	EL1252A1	1 WAY WATER VALVE + J.G. CONNECTION	1	PZ	EL1424A0	D8 CONNECTION WATER SOLENOID VALVE	1	PZ	EL1436A0	H2O SOLENOID JG D8 CHECK VALVE	1	PZ	GN1526A0	INT. D.=6.9 TH=1.8 O-RING	1	PZ	RC1006A0	D8 PET PIPE GUIDE BEND	2	PZ	RC1019A0	D=10 ELASTIC CLAMP	11	PZ	RC1130A0	130X2,6 CLAM	1	PZ	RC1242A0	D=10 CLOSED CAP	2	PZ	RC1310A0	140X4 CLAMP WITH CLIP	2	PZ	RC1356A0	STRAIGHT THREADED FEMALE END 8X1/4" BSP	1	PZ	TB1818A0	JG Ø8 BLUE PE PIPE	0.220	M	TB2820A0	PIPE EPDM FOR WASHING SYSTEM	1.240	M
Code	Description	Qty	UOM																																																											
0H7323A0	WASHING SYSTEM HOLDING PLATE	1	PZ																																																											
0H7511A0	ONE OVENS WASHING SYST HOLDING PLATE	1	PZ																																																											
EL1252A1	1 WAY WATER VALVE + J.G. CONNECTION	1	PZ																																																											
EL1424A0	D8 CONNECTION WATER SOLENOID VALVE	1	PZ																																																											
EL1436A0	H2O SOLENOID JG D8 CHECK VALVE	1	PZ																																																											
GN1526A0	INT. D.=6.9 TH=1.8 O-RING	1	PZ																																																											
RC1006A0	D8 PET PIPE GUIDE BEND	2	PZ																																																											
RC1019A0	D=10 ELASTIC CLAMP	11	PZ																																																											
RC1130A0	130X2,6 CLAM	1	PZ																																																											
RC1242A0	D=10 CLOSED CAP	2	PZ																																																											
RC1310A0	140X4 CLAMP WITH CLIP	2	PZ																																																											
RC1356A0	STRAIGHT THREADED FEMALE END 8X1/4" BSP	1	PZ																																																											
TB1818A0	JG Ø8 BLUE PE PIPE	0.220	M																																																											
TB2820A0	PIPE EPDM FOR WASHING SYSTEM	1.240	M																																																											

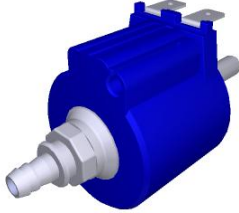
COMPONENT			SPARE PART																																																										
Code	Description	Image	Code	Description	Components list																																																								
VL1019A	VIBRATION PUMP		KVL1108A	04EU ONE EUR 1 ROTOR CLEANING SYSTEM KIT	<table border="1"> <thead> <tr> <th>Code</th> <th>Description</th> <th>Qty</th> <th>UOM</th> </tr> </thead> <tbody> <tr> <td>VI1220A1</td> <td>4,2X12 TCB SELF-TAPPIN G SCREW</td> <td>2</td> <td>PZ</td> </tr> <tr> <td>VL1019A0</td> <td>VIBRATION PUMP</td> <td>1</td> <td>PZ</td> </tr> <tr> <td>VL1053B0</td> <td>ONE WASHING SYS EXT DISTRIBUTOR</td> <td>1</td> <td>PZ</td> </tr> <tr> <td>VL1054B0</td> <td>ONE WASHING SYS INLET DISTRIBUTOR</td> <td>1</td> <td>PZ</td> </tr> <tr> <td>VL1064A0</td> <td>WASHING SYSTEM OUTLETS DISTRIBUTOR</td> <td>1</td> <td>PZ</td> </tr> <tr> <td>VL1065A1</td> <td>1/4 MALE N.O. PRESSURE SWITCH</td> <td>1</td> <td>PZ</td> </tr> <tr> <td>VL1067A0</td> <td>WASHING SYSTEM INLETS DISTRIBUTOR</td> <td>1</td> <td>PZ</td> </tr> <tr> <td>VL1080A0</td> <td>DETERGENT FILTER</td> <td>1</td> <td>PZ</td> </tr> <tr> <td>VL1081A0</td> <td>D6 BARBED NO RETURN VALVE</td> <td>2</td> <td>PZ</td> </tr> <tr> <td>VL1083A0</td> <td>D=10 CONNECTION - D=6 PIPE FITTING</td> <td>1</td> <td>PZ</td> </tr> <tr> <td>VL1102A0</td> <td></td> <td>1</td> <td>PZ</td> </tr> <tr> <td>VL1128A0</td> <td>BARBED CHECK VALVE D6</td> <td>1</td> <td>PZ</td> </tr> <tr> <td>VM2172A0</td> <td>PUMP LOCKING CLIP</td> <td>1</td> <td>PZ</td> </tr> </tbody> </table>	Code	Description	Qty	UOM	VI1220A1	4,2X12 TCB SELF-TAPPIN G SCREW	2	PZ	VL1019A0	VIBRATION PUMP	1	PZ	VL1053B0	ONE WASHING SYS EXT DISTRIBUTOR	1	PZ	VL1054B0	ONE WASHING SYS INLET DISTRIBUTOR	1	PZ	VL1064A0	WASHING SYSTEM OUTLETS DISTRIBUTOR	1	PZ	VL1065A1	1/4 MALE N.O. PRESSURE SWITCH	1	PZ	VL1067A0	WASHING SYSTEM INLETS DISTRIBUTOR	1	PZ	VL1080A0	DETERGENT FILTER	1	PZ	VL1081A0	D6 BARBED NO RETURN VALVE	2	PZ	VL1083A0	D=10 CONNECTION - D=6 PIPE FITTING	1	PZ	VL1102A0		1	PZ	VL1128A0	BARBED CHECK VALVE D6	1	PZ	VM2172A0	PUMP LOCKING CLIP	1	PZ
			Code	Description	Qty	UOM																																																							
VI1220A1	4,2X12 TCB SELF-TAPPIN G SCREW	2	PZ																																																										
VL1019A0	VIBRATION PUMP	1	PZ																																																										
VL1053B0	ONE WASHING SYS EXT DISTRIBUTOR	1	PZ																																																										
VL1054B0	ONE WASHING SYS INLET DISTRIBUTOR	1	PZ																																																										
VL1064A0	WASHING SYSTEM OUTLETS DISTRIBUTOR	1	PZ																																																										
VL1065A1	1/4 MALE N.O. PRESSURE SWITCH	1	PZ																																																										
VL1067A0	WASHING SYSTEM INLETS DISTRIBUTOR	1	PZ																																																										
VL1080A0	DETERGENT FILTER	1	PZ																																																										
VL1081A0	D6 BARBED NO RETURN VALVE	2	PZ																																																										
VL1083A0	D=10 CONNECTION - D=6 PIPE FITTING	1	PZ																																																										
VL1102A0		1	PZ																																																										
VL1128A0	BARBED CHECK VALVE D6	1	PZ																																																										
VM2172A0	PUMP LOCKING CLIP	1	PZ																																																										
KVL1107A	04EU PLUS EUR 1 ROTOR CLEANING SYSTEM KIT	<table border="1"> <thead> <tr> <th>Code</th> <th>Description</th> <th>Qty</th> <th>UOM</th> </tr> </thead> <tbody> <tr> <td>0H7323A0</td> <td>WASHING SYSTEM HOLDING PLATE</td> <td>1</td> <td>PZ</td> </tr> <tr> <td>EL1252A1</td> <td>1 WAY WATER VALVE + J.G. CONNECTION</td> <td>1</td> <td>PZ</td> </tr> <tr> <td>EL1424A0</td> <td>D8 CONNECTION WATER SOLENOID VALVE</td> <td>1</td> <td>PZ</td> </tr> </tbody> </table>	Code	Description	Qty	UOM	0H7323A0	WASHING SYSTEM HOLDING PLATE	1	PZ	EL1252A1	1 WAY WATER VALVE + J.G. CONNECTION	1	PZ	EL1424A0	D8 CONNECTION WATER SOLENOID VALVE	1	PZ																																											
Code	Description	Qty	UOM																																																										
0H7323A0	WASHING SYSTEM HOLDING PLATE	1	PZ																																																										
EL1252A1	1 WAY WATER VALVE + J.G. CONNECTION	1	PZ																																																										
EL1424A0	D8 CONNECTION WATER SOLENOID VALVE	1	PZ																																																										

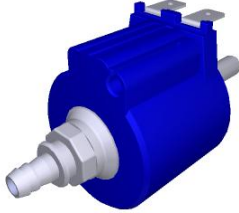

COMPONENT			SPARE PART																																																																																						
Code	Description	Image	Code	Description	Components list																																																																																				
VL1019A	VIBRATION PUMP		KVL1107A	04EU PLUS EUR 1 ROTOR CLEANING SYSTEM KIT	<table border="1"> <thead> <tr> <th>Code</th> <th>Description</th> <th>Qty</th> <th>UOM</th> </tr> </thead> <tbody> <tr> <td>EL1436A0</td> <td>H2O SOLENOID JG D8 CHECK VALVE</td> <td>1</td> <td>PZ</td> </tr> <tr> <td>GN1526A0</td> <td>INT. D.=6.9 TH=1.8 O-RIN</td> <td>1</td> <td>PZ</td> </tr> <tr> <td>RC1019A0</td> <td>D=10 ELASTIC CLAMP</td> <td>11</td> <td>PZ</td> </tr> <tr> <td>RC1130A0</td> <td>130X2,6 CLAM</td> <td>1</td> <td>PZ</td> </tr> <tr> <td>RC1242A0</td> <td>D=10 CLOSED CAP</td> <td>2</td> <td>PZ</td> </tr> <tr> <td>RC1310A0</td> <td>140X4 CLAMP WITH CLIP</td> <td>2</td> <td>PZ</td> </tr> <tr> <td>RC1356A0</td> <td>STRAIGHT THREADED FEMALE END 8X1/4" BSP</td> <td>1</td> <td>PZ</td> </tr> <tr> <td>TB2820A0</td> <td>PIPE EPDM FOR WASHING SYSTEM</td> <td>2.040</td> <td>M</td> </tr> <tr> <td>VI1220A1</td> <td>4,2X12 TCB SELF-TAPPIN G SCREW</td> <td>2</td> <td>PZ</td> </tr> <tr> <td>VL1019A0</td> <td>VIBRATION PUMP</td> <td>1</td> <td>PZ</td> </tr> <tr> <td>VL1064A0</td> <td>WASHING SYSTEM OUTLETS DISTRIBUTOR</td> <td>1</td> <td>PZ</td> </tr> <tr> <td>VL1065A1</td> <td>1/4 MALE N.O. PRESSURE SWITCH</td> <td>1</td> <td>PZ</td> </tr> <tr> <td>VL1067A0</td> <td>WASHING SYSTEM INLETS DISTRIBUTOR</td> <td>1</td> <td>PZ</td> </tr> <tr> <td>VL1080A0</td> <td>DETERGENT FILTER</td> <td>1</td> <td>PZ</td> </tr> <tr> <td>VL1081A0</td> <td>D6 BARBED NO RETURN VALVE</td> <td>2</td> <td>PZ</td> </tr> <tr> <td>VL1083A0</td> <td>D=10 CONNECTION - D=6 PIPE FITTING</td> <td>1</td> <td>PZ</td> </tr> <tr> <td>VL1102A0</td> <td></td> <td>1</td> <td>PZ</td> </tr> <tr> <td>VL1102A1</td> <td>DETERGENT LINE FILTER + BARBED VNR 6 MM</td> <td>1</td> <td>PZ</td> </tr> <tr> <td>VL1128A0</td> <td>BARBED CHECK VALVE D6</td> <td>1</td> <td>PZ</td> </tr> <tr> <td>VM2172A0</td> <td>PUMP LOCKING CLIP</td> <td>1</td> <td>PZ</td> </tr> </tbody> </table>	Code	Description	Qty	UOM	EL1436A0	H2O SOLENOID JG D8 CHECK VALVE	1	PZ	GN1526A0	INT. D.=6.9 TH=1.8 O-RIN	1	PZ	RC1019A0	D=10 ELASTIC CLAMP	11	PZ	RC1130A0	130X2,6 CLAM	1	PZ	RC1242A0	D=10 CLOSED CAP	2	PZ	RC1310A0	140X4 CLAMP WITH CLIP	2	PZ	RC1356A0	STRAIGHT THREADED FEMALE END 8X1/4" BSP	1	PZ	TB2820A0	PIPE EPDM FOR WASHING SYSTEM	2.040	M	VI1220A1	4,2X12 TCB SELF-TAPPIN G SCREW	2	PZ	VL1019A0	VIBRATION PUMP	1	PZ	VL1064A0	WASHING SYSTEM OUTLETS DISTRIBUTOR	1	PZ	VL1065A1	1/4 MALE N.O. PRESSURE SWITCH	1	PZ	VL1067A0	WASHING SYSTEM INLETS DISTRIBUTOR	1	PZ	VL1080A0	DETERGENT FILTER	1	PZ	VL1081A0	D6 BARBED NO RETURN VALVE	2	PZ	VL1083A0	D=10 CONNECTION - D=6 PIPE FITTING	1	PZ	VL1102A0		1	PZ	VL1102A1	DETERGENT LINE FILTER + BARBED VNR 6 MM	1	PZ	VL1128A0	BARBED CHECK VALVE D6	1	PZ	VM2172A0	PUMP LOCKING CLIP	1	PZ
Code	Description	Qty	UOM																																																																																						
EL1436A0	H2O SOLENOID JG D8 CHECK VALVE	1	PZ																																																																																						
GN1526A0	INT. D.=6.9 TH=1.8 O-RIN	1	PZ																																																																																						
RC1019A0	D=10 ELASTIC CLAMP	11	PZ																																																																																						
RC1130A0	130X2,6 CLAM	1	PZ																																																																																						
RC1242A0	D=10 CLOSED CAP	2	PZ																																																																																						
RC1310A0	140X4 CLAMP WITH CLIP	2	PZ																																																																																						
RC1356A0	STRAIGHT THREADED FEMALE END 8X1/4" BSP	1	PZ																																																																																						
TB2820A0	PIPE EPDM FOR WASHING SYSTEM	2.040	M																																																																																						
VI1220A1	4,2X12 TCB SELF-TAPPIN G SCREW	2	PZ																																																																																						
VL1019A0	VIBRATION PUMP	1	PZ																																																																																						
VL1064A0	WASHING SYSTEM OUTLETS DISTRIBUTOR	1	PZ																																																																																						
VL1065A1	1/4 MALE N.O. PRESSURE SWITCH	1	PZ																																																																																						
VL1067A0	WASHING SYSTEM INLETS DISTRIBUTOR	1	PZ																																																																																						
VL1080A0	DETERGENT FILTER	1	PZ																																																																																						
VL1081A0	D6 BARBED NO RETURN VALVE	2	PZ																																																																																						
VL1083A0	D=10 CONNECTION - D=6 PIPE FITTING	1	PZ																																																																																						
VL1102A0		1	PZ																																																																																						
VL1102A1	DETERGENT LINE FILTER + BARBED VNR 6 MM	1	PZ																																																																																						
VL1128A0	BARBED CHECK VALVE D6	1	PZ																																																																																						
VM2172A0	PUMP LOCKING CLIP	1	PZ																																																																																						

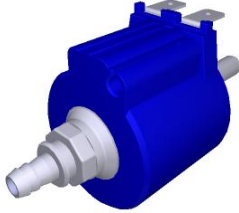
COMPONENT			SPARE PART																																																																														
Code	Description	Image	Code	Description	Components list																																																																												
VL1019A	VIBRATION PUMP		KVL1106A	EUR 1 ROTOR ARM ONE CLEANING SYSTEM KIT	<table border="1"> <thead> <tr> <th>Code</th> <th>Description</th> <th>Qty</th> <th>UOM</th> </tr> </thead> <tbody> <tr> <td>0H7324A0</td> <td>ONE OVENS WASHING SYST HOLDING PLATE</td> <td>1</td> <td>PZ</td> </tr> <tr> <td>0H7819A0</td> <td>ONE WASHING SYS SUPPORT WITH STEAM VALVE</td> <td>1</td> <td>PZ</td> </tr> <tr> <td>EL1436A0</td> <td>H2O SOLENOID JG D8 CHECK VALVE</td> <td>1</td> <td>PZ</td> </tr> <tr> <td>GN1526A0</td> <td>INT. D.=6.9 TH=1.8 O-RIN</td> <td>1</td> <td>PZ</td> </tr> <tr> <td>RC1006A0</td> <td>D8 PET PIPE GUIDE BEND</td> <td>2</td> <td>PZ</td> </tr> <tr> <td>RC1019A0</td> <td>D=10 ELASTIC CLAMP</td> <td>15</td> <td>PZ</td> </tr> <tr> <td>RC1242A0</td> <td>D=10 CLOSED CAP</td> <td>2</td> <td>PZ</td> </tr> <tr> <td>RC1408A0</td> <td>DOUBLE WIRE SPRING CLAMP D10.8 ZN</td> <td>2</td> <td>PZ</td> </tr> <tr> <td>TB1818A0</td> <td>JG Ø8 BLUE PE PIPE</td> <td>0.320</td> <td>M</td> </tr> <tr> <td>TB2820A0</td> <td>PIPE EPDM FOR WASHING SYSTEM</td> <td>1.380</td> <td>M</td> </tr> <tr> <td>VH1220A1</td> <td>4,2X12 TCB SELF-TAPPIN G SCREW</td> <td>1</td> <td>PZ</td> </tr> <tr> <td>VL1019A0</td> <td>VIBRATION PUMP</td> <td>1</td> <td>PZ</td> </tr> <tr> <td>VL1053B0</td> <td>ONE WASHING SYS EXT DISTRIBUTOR</td> <td>1</td> <td>PZ</td> </tr> <tr> <td>VL1054B0</td> <td>ONE WASHING SYS INLET DISTRIBUTOR</td> <td>1</td> <td>PZ</td> </tr> <tr> <td>VL1080A0</td> <td>DETERGENT FILTER</td> <td>1</td> <td>PZ</td> </tr> <tr> <td>VL1081A0</td> <td>D6 BARBED NO RETURN VALVE</td> <td>1</td> <td>PZ</td> </tr> <tr> <td>VL1102A0</td> <td></td> <td>1</td> <td>PZ</td> </tr> <tr> <td>VL1102A1</td> <td>DETERGENT LINE FILTER + BARBED VNR 6 MM</td> <td>1</td> <td>PZ</td> </tr> </tbody> </table>	Code	Description	Qty	UOM	0H7324A0	ONE OVENS WASHING SYST HOLDING PLATE	1	PZ	0H7819A0	ONE WASHING SYS SUPPORT WITH STEAM VALVE	1	PZ	EL1436A0	H2O SOLENOID JG D8 CHECK VALVE	1	PZ	GN1526A0	INT. D.=6.9 TH=1.8 O-RIN	1	PZ	RC1006A0	D8 PET PIPE GUIDE BEND	2	PZ	RC1019A0	D=10 ELASTIC CLAMP	15	PZ	RC1242A0	D=10 CLOSED CAP	2	PZ	RC1408A0	DOUBLE WIRE SPRING CLAMP D10.8 ZN	2	PZ	TB1818A0	JG Ø8 BLUE PE PIPE	0.320	M	TB2820A0	PIPE EPDM FOR WASHING SYSTEM	1.380	M	VH1220A1	4,2X12 TCB SELF-TAPPIN G SCREW	1	PZ	VL1019A0	VIBRATION PUMP	1	PZ	VL1053B0	ONE WASHING SYS EXT DISTRIBUTOR	1	PZ	VL1054B0	ONE WASHING SYS INLET DISTRIBUTOR	1	PZ	VL1080A0	DETERGENT FILTER	1	PZ	VL1081A0	D6 BARBED NO RETURN VALVE	1	PZ	VL1102A0		1	PZ	VL1102A1	DETERGENT LINE FILTER + BARBED VNR 6 MM	1	PZ
Code	Description	Qty	UOM																																																																														
0H7324A0	ONE OVENS WASHING SYST HOLDING PLATE	1	PZ																																																																														
0H7819A0	ONE WASHING SYS SUPPORT WITH STEAM VALVE	1	PZ																																																																														
EL1436A0	H2O SOLENOID JG D8 CHECK VALVE	1	PZ																																																																														
GN1526A0	INT. D.=6.9 TH=1.8 O-RIN	1	PZ																																																																														
RC1006A0	D8 PET PIPE GUIDE BEND	2	PZ																																																																														
RC1019A0	D=10 ELASTIC CLAMP	15	PZ																																																																														
RC1242A0	D=10 CLOSED CAP	2	PZ																																																																														
RC1408A0	DOUBLE WIRE SPRING CLAMP D10.8 ZN	2	PZ																																																																														
TB1818A0	JG Ø8 BLUE PE PIPE	0.320	M																																																																														
TB2820A0	PIPE EPDM FOR WASHING SYSTEM	1.380	M																																																																														
VH1220A1	4,2X12 TCB SELF-TAPPIN G SCREW	1	PZ																																																																														
VL1019A0	VIBRATION PUMP	1	PZ																																																																														
VL1053B0	ONE WASHING SYS EXT DISTRIBUTOR	1	PZ																																																																														
VL1054B0	ONE WASHING SYS INLET DISTRIBUTOR	1	PZ																																																																														
VL1080A0	DETERGENT FILTER	1	PZ																																																																														
VL1081A0	D6 BARBED NO RETURN VALVE	1	PZ																																																																														
VL1102A0		1	PZ																																																																														
VL1102A1	DETERGENT LINE FILTER + BARBED VNR 6 MM	1	PZ																																																																														

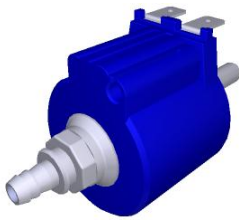
COMPONENT			SPARE PART																																																											
Code	Description	Image	Code	Description	Components list																																																									
VL1019A	VIBRATION PUMP		KVL1106A	EUR 1 ROTOR ARM ONE CLEANING SYSTEM KIT	<table border="1"> <thead> <tr> <th>Code</th> <th>Description</th> <th>Qty</th> <th>UOM</th> </tr> </thead> <tbody> <tr> <td>VL1128A0</td> <td>BARBED CHECK VALVE D6</td> <td>1</td> <td>PZ</td> </tr> <tr> <td>VM2172A0</td> <td>PUMP LOCKING CLIP</td> <td>1</td> <td>PZ</td> </tr> </tbody> </table>	Code	Description	Qty	UOM	VL1128A0	BARBED CHECK VALVE D6	1	PZ	VM2172A0	PUMP LOCKING CLIP	1	PZ																																													
			Code	Description	Qty	UOM																																																								
VL1128A0	BARBED CHECK VALVE D6	1	PZ																																																											
VM2172A0	PUMP LOCKING CLIP	1	PZ																																																											
KVL1105A	USA 2 ROTOR ARMS PLUS CLEANING SYSTEM KIT	<table border="1"> <thead> <tr> <th>Code</th> <th>Description</th> <th>Qty</th> <th>UOM</th> </tr> </thead> <tbody> <tr> <td>0H7323A0</td> <td>WASHING SYSTEM HOLDING PLATE</td> <td>1</td> <td>PZ</td> </tr> <tr> <td>0H7820A0</td> <td>PLUS WASHING SY SUPPORT WITH STEAM VALVE</td> <td>1</td> <td>PZ</td> </tr> <tr> <td>EL1020A1</td> <td>D8 INTERMEDIAT E T-SHAPED FITTING</td> <td>1</td> <td>PZ</td> </tr> <tr> <td>EL1422A0</td> <td>1 WAY SOLENOID VALVE + D8-D10 REDUCTION</td> <td>1</td> <td>PZ</td> </tr> <tr> <td>EL1422A1</td> <td>1 WAY SOLENOID VALVE + D8-D10 REDUCTION</td> <td>1</td> <td>PZ</td> </tr> <tr> <td>EL1426A0</td> <td>H2O UL SOLENOID JG D8-PIPE HOLDER</td> <td>2</td> <td>PZ</td> </tr> <tr> <td>EL1437A0</td> <td>H2O SOLENOID JG D6 UL CHECK VALVE</td> <td>1</td> <td>PZ</td> </tr> <tr> <td>GN1526A0</td> <td>INT. D.=6.9 TH=1.8 O-RIN</td> <td>1</td> <td>PZ</td> </tr> <tr> <td>RC1019A0</td> <td>D=10 ELASTIC CLAMP</td> <td>12</td> <td>PZ</td> </tr> <tr> <td>RC1130A0</td> <td>130X2,6 CLAM</td> <td>1</td> <td>PZ</td> </tr> <tr> <td>RC1242A0</td> <td>D=10 CLOSED CAP</td> <td>2</td> <td>PZ</td> </tr> <tr> <td>RC1310A0</td> <td>140X4 CLAMP WITH CLIP</td> <td>2</td> <td>PZ</td> </tr> <tr> <td>RC1356A0</td> <td>STRAIGHT THREADED FEMALE END 8X1/4" BSP</td> <td>1</td> <td>PZ</td> </tr> <tr> <td>RC1408A0</td> <td>DOUBLE WIRE SPRING CLAMP D10.8 ZN</td> <td>2</td> <td>PZ</td> </tr> </tbody> </table>	Code	Description	Qty	UOM	0H7323A0	WASHING SYSTEM HOLDING PLATE	1	PZ	0H7820A0	PLUS WASHING SY SUPPORT WITH STEAM VALVE	1	PZ	EL1020A1	D8 INTERMEDIAT E T-SHAPED FITTING	1	PZ	EL1422A0	1 WAY SOLENOID VALVE + D8-D10 REDUCTION	1	PZ	EL1422A1	1 WAY SOLENOID VALVE + D8-D10 REDUCTION	1	PZ	EL1426A0	H2O UL SOLENOID JG D8-PIPE HOLDER	2	PZ	EL1437A0	H2O SOLENOID JG D6 UL CHECK VALVE	1	PZ	GN1526A0	INT. D.=6.9 TH=1.8 O-RIN	1	PZ	RC1019A0	D=10 ELASTIC CLAMP	12	PZ	RC1130A0	130X2,6 CLAM	1	PZ	RC1242A0	D=10 CLOSED CAP	2	PZ	RC1310A0	140X4 CLAMP WITH CLIP	2	PZ	RC1356A0	STRAIGHT THREADED FEMALE END 8X1/4" BSP	1	PZ	RC1408A0	DOUBLE WIRE SPRING CLAMP D10.8 ZN	2	PZ
Code	Description	Qty	UOM																																																											
0H7323A0	WASHING SYSTEM HOLDING PLATE	1	PZ																																																											
0H7820A0	PLUS WASHING SY SUPPORT WITH STEAM VALVE	1	PZ																																																											
EL1020A1	D8 INTERMEDIAT E T-SHAPED FITTING	1	PZ																																																											
EL1422A0	1 WAY SOLENOID VALVE + D8-D10 REDUCTION	1	PZ																																																											
EL1422A1	1 WAY SOLENOID VALVE + D8-D10 REDUCTION	1	PZ																																																											
EL1426A0	H2O UL SOLENOID JG D8-PIPE HOLDER	2	PZ																																																											
EL1437A0	H2O SOLENOID JG D6 UL CHECK VALVE	1	PZ																																																											
GN1526A0	INT. D.=6.9 TH=1.8 O-RIN	1	PZ																																																											
RC1019A0	D=10 ELASTIC CLAMP	12	PZ																																																											
RC1130A0	130X2,6 CLAM	1	PZ																																																											
RC1242A0	D=10 CLOSED CAP	2	PZ																																																											
RC1310A0	140X4 CLAMP WITH CLIP	2	PZ																																																											
RC1356A0	STRAIGHT THREADED FEMALE END 8X1/4" BSP	1	PZ																																																											
RC1408A0	DOUBLE WIRE SPRING CLAMP D10.8 ZN	2	PZ																																																											

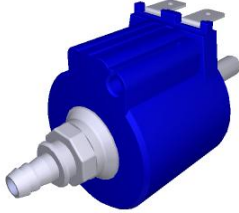
COMPONENT			SPARE PART																																																																													
Code	Description	Image	Code	Description	Components list																																																																											
VL1019A	VIBRATION PUMP		KVL1105A	USA 2 ROTOR ARMS PLUS CLEANING SYSTEM KIT	<table border="1"> <thead> <tr> <th>Code</th> <th>Description</th> <th>Qty</th> <th>UOM</th> </tr> </thead> <tbody> <tr> <td>TB1818A0</td> <td>JG Ø8 BLUE PE PIPE</td> <td>0.300</td> <td>M</td> </tr> <tr> <td>TB2820A0</td> <td>PIPE EPDM FOR WASHING SYSTEM</td> <td>2.040</td> <td>M</td> </tr> <tr> <td>VI1220A1</td> <td>4,2X12 TCB SELF-TAPPIN G SCREW</td> <td>2</td> <td>PZ</td> </tr> <tr> <td>VL1019A0</td> <td>VIBRATION PUMP</td> <td>1</td> <td>PZ</td> </tr> <tr> <td>VL1065A1</td> <td>1/4 MALE N.O. PRESSURE SWITCH</td> <td>1</td> <td>PZ</td> </tr> <tr> <td>VL1067A0</td> <td>WASHING SYSTEM INLETS DISTRIBUTOR</td> <td>1</td> <td>PZ</td> </tr> <tr> <td>VL1080A0</td> <td>DETERGENT FILTER</td> <td>1</td> <td>PZ</td> </tr> <tr> <td>VL1081A0</td> <td>D6 BARBED NO RETURN VALVE</td> <td>2</td> <td>PZ</td> </tr> <tr> <td>VL1083A0</td> <td>D=10 CONNECTION - D=6 PIPE FITTING</td> <td>1</td> <td>PZ</td> </tr> <tr> <td>VL1092A0</td> <td>WASHING SYSTEM OUTLET DOUBLE DISTRIBUTOR</td> <td>1</td> <td>PZ</td> </tr> <tr> <td>VL1102A0</td> <td></td> <td>1</td> <td>PZ</td> </tr> <tr> <td>VL1102A1</td> <td>DETERGENT LINE FILTER + BARBED VNR 6 MM</td> <td>1</td> <td>PZ</td> </tr> <tr> <td>VL1128A0</td> <td>BARBED CHECK VALVE D6</td> <td>1</td> <td>PZ</td> </tr> <tr> <td>VM2172A0</td> <td>PUMP LOCKING CLIP</td> <td>1</td> <td>PZ</td> </tr> </tbody> </table>	Code	Description	Qty	UOM	TB1818A0	JG Ø8 BLUE PE PIPE	0.300	M	TB2820A0	PIPE EPDM FOR WASHING SYSTEM	2.040	M	VI1220A1	4,2X12 TCB SELF-TAPPIN G SCREW	2	PZ	VL1019A0	VIBRATION PUMP	1	PZ	VL1065A1	1/4 MALE N.O. PRESSURE SWITCH	1	PZ	VL1067A0	WASHING SYSTEM INLETS DISTRIBUTOR	1	PZ	VL1080A0	DETERGENT FILTER	1	PZ	VL1081A0	D6 BARBED NO RETURN VALVE	2	PZ	VL1083A0	D=10 CONNECTION - D=6 PIPE FITTING	1	PZ	VL1092A0	WASHING SYSTEM OUTLET DOUBLE DISTRIBUTOR	1	PZ	VL1102A0		1	PZ	VL1102A1	DETERGENT LINE FILTER + BARBED VNR 6 MM	1	PZ	VL1128A0	BARBED CHECK VALVE D6	1	PZ	VM2172A0	PUMP LOCKING CLIP	1	PZ	KVL1104A	USA 1 ROTOR ARM PLUS CLEANING SYSTEM KIT	<table border="1"> <thead> <tr> <th>Code</th> <th>Description</th> <th>Qty</th> <th>UOM</th> </tr> </thead> <tbody> <tr> <td>0H7323A0</td> <td>WASHING SYSTEM HOLDING PLATE</td> <td>1</td> <td>PZ</td> </tr> <tr> <td>0H7820A0</td> <td>PLUS WASHING SY SUPPORT WITH STEAM VALVE</td> <td>1</td> <td>PZ</td> </tr> </tbody> </table>	Code	Description	Qty	UOM	0H7323A0	WASHING SYSTEM HOLDING PLATE	1	PZ	0H7820A0	PLUS WASHING SY SUPPORT WITH STEAM VALVE	1	PZ
			Code	Description	Qty	UOM																																																																										
TB1818A0	JG Ø8 BLUE PE PIPE	0.300	M																																																																													
TB2820A0	PIPE EPDM FOR WASHING SYSTEM	2.040	M																																																																													
VI1220A1	4,2X12 TCB SELF-TAPPIN G SCREW	2	PZ																																																																													
VL1019A0	VIBRATION PUMP	1	PZ																																																																													
VL1065A1	1/4 MALE N.O. PRESSURE SWITCH	1	PZ																																																																													
VL1067A0	WASHING SYSTEM INLETS DISTRIBUTOR	1	PZ																																																																													
VL1080A0	DETERGENT FILTER	1	PZ																																																																													
VL1081A0	D6 BARBED NO RETURN VALVE	2	PZ																																																																													
VL1083A0	D=10 CONNECTION - D=6 PIPE FITTING	1	PZ																																																																													
VL1092A0	WASHING SYSTEM OUTLET DOUBLE DISTRIBUTOR	1	PZ																																																																													
VL1102A0		1	PZ																																																																													
VL1102A1	DETERGENT LINE FILTER + BARBED VNR 6 MM	1	PZ																																																																													
VL1128A0	BARBED CHECK VALVE D6	1	PZ																																																																													
VM2172A0	PUMP LOCKING CLIP	1	PZ																																																																													
Code	Description	Qty	UOM																																																																													
0H7323A0	WASHING SYSTEM HOLDING PLATE	1	PZ																																																																													
0H7820A0	PLUS WASHING SY SUPPORT WITH STEAM VALVE	1	PZ																																																																													

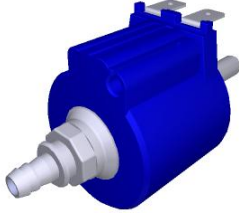
COMPONENT			SPARE PART																																																																										
Code	Description	Image	Code	Description	Components list																																																																								
VL1019A	VIBRATION PUMP		KVL1104A	USA 1 ROTOR ARM PLUS CLEANING SYSTEM KIT	<table border="1"> <thead> <tr> <th>Code</th> <th>Description</th> <th>Qty</th> <th>UOM</th> </tr> </thead> <tbody> <tr> <td>EL1020A1</td> <td>D8 INTERMEDIAT E T-SHAPED FITTING</td> <td>1</td> <td>PZ</td> </tr> <tr> <td>EL1422A0</td> <td>1 WAY SOLENOID VALVE + D8-D10 REDUCTION</td> <td>1</td> <td>PZ</td> </tr> <tr> <td>EL1422A1</td> <td>1 WAY SOLENOID VALVE + D8-D10 REDUCTION</td> <td>1</td> <td>PZ</td> </tr> <tr> <td>EL1426A0</td> <td>H2O UL SOLENOID JG D8-PIPE HOLDER</td> <td>1</td> <td>PZ</td> </tr> <tr> <td>EL1437A0</td> <td>H2O SOLENOID JG D6 UL CHECK VALVE</td> <td>1</td> <td>PZ</td> </tr> <tr> <td>GN1526A0</td> <td>INT. D.=6.9 TH=1.8 O-RIN</td> <td>1</td> <td>PZ</td> </tr> <tr> <td>RC1019A0</td> <td>D=10 ELASTIC CLAMP</td> <td>11</td> <td>PZ</td> </tr> <tr> <td>RC1130A0</td> <td>130X2,6 CLAM</td> <td>1</td> <td>PZ</td> </tr> <tr> <td>RC1242A0</td> <td>D=10 CLOSED CAP</td> <td>2</td> <td>PZ</td> </tr> <tr> <td>RC1310A0</td> <td>140X4 CLAMP WITH CLIP</td> <td>2</td> <td>PZ</td> </tr> <tr> <td>RC1356A0</td> <td>STRAIGHT THREADED FEMALE END 8X1/4" BSP</td> <td>1</td> <td>PZ</td> </tr> <tr> <td>RC1408A0</td> <td>DOUBLE WIRE SPRING CLAMP D10.8 ZN</td> <td>2</td> <td>PZ</td> </tr> <tr> <td>TB1818A0</td> <td>JG Ø8 BLUE PE PIPE</td> <td>0.300</td> <td>M</td> </tr> <tr> <td>TB2820A0</td> <td>PIPE EPDM FOR WASHING SYSTEM</td> <td>1.240</td> <td>M</td> </tr> <tr> <td>VI1220A1</td> <td>4,2X12 TCB SELF-TAPPIN G SCREW</td> <td>2</td> <td>PZ</td> </tr> <tr> <td>VL1019A0</td> <td>VIBRATION PUMP</td> <td>1</td> <td>PZ</td> </tr> <tr> <td>VL1064A0</td> <td>WASHING SYSTEM OUTLETS DISTRIBUTOR</td> <td>1</td> <td>PZ</td> </tr> </tbody> </table>	Code	Description	Qty	UOM	EL1020A1	D8 INTERMEDIAT E T-SHAPED FITTING	1	PZ	EL1422A0	1 WAY SOLENOID VALVE + D8-D10 REDUCTION	1	PZ	EL1422A1	1 WAY SOLENOID VALVE + D8-D10 REDUCTION	1	PZ	EL1426A0	H2O UL SOLENOID JG D8-PIPE HOLDER	1	PZ	EL1437A0	H2O SOLENOID JG D6 UL CHECK VALVE	1	PZ	GN1526A0	INT. D.=6.9 TH=1.8 O-RIN	1	PZ	RC1019A0	D=10 ELASTIC CLAMP	11	PZ	RC1130A0	130X2,6 CLAM	1	PZ	RC1242A0	D=10 CLOSED CAP	2	PZ	RC1310A0	140X4 CLAMP WITH CLIP	2	PZ	RC1356A0	STRAIGHT THREADED FEMALE END 8X1/4" BSP	1	PZ	RC1408A0	DOUBLE WIRE SPRING CLAMP D10.8 ZN	2	PZ	TB1818A0	JG Ø8 BLUE PE PIPE	0.300	M	TB2820A0	PIPE EPDM FOR WASHING SYSTEM	1.240	M	VI1220A1	4,2X12 TCB SELF-TAPPIN G SCREW	2	PZ	VL1019A0	VIBRATION PUMP	1	PZ	VL1064A0	WASHING SYSTEM OUTLETS DISTRIBUTOR	1	PZ
Code	Description	Qty	UOM																																																																										
EL1020A1	D8 INTERMEDIAT E T-SHAPED FITTING	1	PZ																																																																										
EL1422A0	1 WAY SOLENOID VALVE + D8-D10 REDUCTION	1	PZ																																																																										
EL1422A1	1 WAY SOLENOID VALVE + D8-D10 REDUCTION	1	PZ																																																																										
EL1426A0	H2O UL SOLENOID JG D8-PIPE HOLDER	1	PZ																																																																										
EL1437A0	H2O SOLENOID JG D6 UL CHECK VALVE	1	PZ																																																																										
GN1526A0	INT. D.=6.9 TH=1.8 O-RIN	1	PZ																																																																										
RC1019A0	D=10 ELASTIC CLAMP	11	PZ																																																																										
RC1130A0	130X2,6 CLAM	1	PZ																																																																										
RC1242A0	D=10 CLOSED CAP	2	PZ																																																																										
RC1310A0	140X4 CLAMP WITH CLIP	2	PZ																																																																										
RC1356A0	STRAIGHT THREADED FEMALE END 8X1/4" BSP	1	PZ																																																																										
RC1408A0	DOUBLE WIRE SPRING CLAMP D10.8 ZN	2	PZ																																																																										
TB1818A0	JG Ø8 BLUE PE PIPE	0.300	M																																																																										
TB2820A0	PIPE EPDM FOR WASHING SYSTEM	1.240	M																																																																										
VI1220A1	4,2X12 TCB SELF-TAPPIN G SCREW	2	PZ																																																																										
VL1019A0	VIBRATION PUMP	1	PZ																																																																										
VL1064A0	WASHING SYSTEM OUTLETS DISTRIBUTOR	1	PZ																																																																										

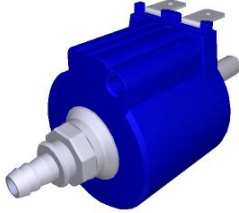

COMPONENT			SPARE PART																																										
Code	Description	Image	Code	Description	Components list																																								
VL1019A	VIBRATION PUMP		KVL1104A	USA 1 ROTOR ARM PLUS CLEANING SYSTEM KIT	<table border="1"> <thead> <tr> <th>Code</th> <th>Description</th> <th>Qty</th> <th>UOM</th> </tr> </thead> <tbody> <tr> <td>VL1065A1</td> <td>1/4 MALE N.O. PRESSURE SWITCH</td> <td>1</td> <td>PZ</td> </tr> <tr> <td>VL1067A0</td> <td>WASHING SYSTEM INLETS DISTRIBUTOR</td> <td>1</td> <td>PZ</td> </tr> <tr> <td>VL1080A0</td> <td>DETERGENT FILTER</td> <td>1</td> <td>PZ</td> </tr> <tr> <td>VL1081A0</td> <td>D6 BARBED NO RETURN VALVE</td> <td>2</td> <td>PZ</td> </tr> <tr> <td>VL1083A0</td> <td>D=10 CONNECTION - D=6 PIPE FITTING</td> <td>1</td> <td>PZ</td> </tr> <tr> <td>VL1102A0</td> <td></td> <td>1</td> <td>PZ</td> </tr> <tr> <td>VL1102A1</td> <td>DETERGENT LINE FILTER + BARBED VNR 6 MM</td> <td>1</td> <td>PZ</td> </tr> <tr> <td>VL1128A0</td> <td>BARBED CHECK VALVE D6</td> <td>1</td> <td>PZ</td> </tr> <tr> <td>VM2172A0</td> <td>PUMP LOCKING CLIP</td> <td>1</td> <td>PZ</td> </tr> </tbody> </table>	Code	Description	Qty	UOM	VL1065A1	1/4 MALE N.O. PRESSURE SWITCH	1	PZ	VL1067A0	WASHING SYSTEM INLETS DISTRIBUTOR	1	PZ	VL1080A0	DETERGENT FILTER	1	PZ	VL1081A0	D6 BARBED NO RETURN VALVE	2	PZ	VL1083A0	D=10 CONNECTION - D=6 PIPE FITTING	1	PZ	VL1102A0		1	PZ	VL1102A1	DETERGENT LINE FILTER + BARBED VNR 6 MM	1	PZ	VL1128A0	BARBED CHECK VALVE D6	1	PZ	VM2172A0	PUMP LOCKING CLIP	1	PZ
			Code	Description	Qty	UOM																																							
VL1065A1	1/4 MALE N.O. PRESSURE SWITCH	1	PZ																																										
VL1067A0	WASHING SYSTEM INLETS DISTRIBUTOR	1	PZ																																										
VL1080A0	DETERGENT FILTER	1	PZ																																										
VL1081A0	D6 BARBED NO RETURN VALVE	2	PZ																																										
VL1083A0	D=10 CONNECTION - D=6 PIPE FITTING	1	PZ																																										
VL1102A0		1	PZ																																										
VL1102A1	DETERGENT LINE FILTER + BARBED VNR 6 MM	1	PZ																																										
VL1128A0	BARBED CHECK VALVE D6	1	PZ																																										
VM2172A0	PUMP LOCKING CLIP	1	PZ																																										
KVL1103A	EUR 2 ROTOR ARMS PLUS CLEANING SYSTEM KIT	<table border="1"> <thead> <tr> <th>Code</th> <th>Description</th> <th>Qty</th> <th>UOM</th> </tr> </thead> <tbody> <tr> <td>0H7323A0</td> <td>WASHING SYSTEM HOLDING PLATE</td> <td>1</td> <td>PZ</td> </tr> <tr> <td>0H7820A0</td> <td>PLUS WASHING SY SUPPORT WITH STEAM VALVE</td> <td>1</td> <td>PZ</td> </tr> <tr> <td>EL1252A1</td> <td>1 WAY WATER VALVE + J.G. CONNECTION</td> <td>1</td> <td>PZ</td> </tr> <tr> <td>EL1424A0</td> <td>D8 CONNECTION WATER SOLENOID VALVE</td> <td>2</td> <td>PZ</td> </tr> <tr> <td>EL1436A0</td> <td>H2O SOLENOID JG D8 CHECK VALVE</td> <td>1</td> <td>PZ</td> </tr> <tr> <td>GN1526A0</td> <td>INT. D.=6.9 TH=1.8 O-RIN</td> <td>1</td> <td>PZ</td> </tr> <tr> <td>RC1019A0</td> <td>D=10 ELASTIC CLAMP</td> <td>12</td> <td>PZ</td> </tr> <tr> <td>RC1130A0</td> <td>130X2,6 CLAM</td> <td>1</td> <td>PZ</td> </tr> </tbody> </table>	Code	Description	Qty	UOM	0H7323A0	WASHING SYSTEM HOLDING PLATE	1	PZ	0H7820A0	PLUS WASHING SY SUPPORT WITH STEAM VALVE	1	PZ	EL1252A1	1 WAY WATER VALVE + J.G. CONNECTION	1	PZ	EL1424A0	D8 CONNECTION WATER SOLENOID VALVE	2	PZ	EL1436A0	H2O SOLENOID JG D8 CHECK VALVE	1	PZ	GN1526A0	INT. D.=6.9 TH=1.8 O-RIN	1	PZ	RC1019A0	D=10 ELASTIC CLAMP	12	PZ	RC1130A0	130X2,6 CLAM	1	PZ							
Code	Description	Qty	UOM																																										
0H7323A0	WASHING SYSTEM HOLDING PLATE	1	PZ																																										
0H7820A0	PLUS WASHING SY SUPPORT WITH STEAM VALVE	1	PZ																																										
EL1252A1	1 WAY WATER VALVE + J.G. CONNECTION	1	PZ																																										
EL1424A0	D8 CONNECTION WATER SOLENOID VALVE	2	PZ																																										
EL1436A0	H2O SOLENOID JG D8 CHECK VALVE	1	PZ																																										
GN1526A0	INT. D.=6.9 TH=1.8 O-RIN	1	PZ																																										
RC1019A0	D=10 ELASTIC CLAMP	12	PZ																																										
RC1130A0	130X2,6 CLAM	1	PZ																																										

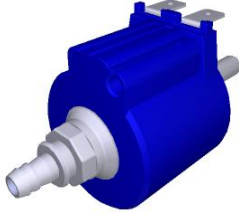
COMPONENT			SPARE PART																																																																														
Code	Description	Image	Code	Description	Components list																																																																												
VL1019A	VIBRATION PUMP		KVL1103A	EUR 2 ROTOR ARMS PLUS CLEANING SYSTEM KIT	<table border="1"> <thead> <tr> <th>Code</th> <th>Description</th> <th>Qty</th> <th>UOM</th> </tr> </thead> <tbody> <tr> <td>RC1242A0</td> <td>D=10 CLOSED CAP</td> <td>2</td> <td>PZ</td> </tr> <tr> <td>RC1310A0</td> <td>140X4 CLAMP WITH CLIP</td> <td>2</td> <td>PZ</td> </tr> <tr> <td>RC1356A0</td> <td>STRAIGHT THREADED FEMALE END 8X1/4" BSP</td> <td>1</td> <td>PZ</td> </tr> <tr> <td>RC1408A0</td> <td>DOUBLE WIRE SPRING CLAMP D10.8 ZN</td> <td>2</td> <td>PZ</td> </tr> <tr> <td>TB1818A0</td> <td>JG Ø8 BLUE PE PIPE</td> <td>0.220</td> <td>M</td> </tr> <tr> <td>TB2820A0</td> <td>PIPE EPDM FOR WASHING SYSTEM</td> <td>2.040</td> <td>M</td> </tr> <tr> <td>VI1220A1</td> <td>4.2X12 TCB SELF-TAPPIN G SCREW</td> <td>2</td> <td>PZ</td> </tr> <tr> <td>VL1019A0</td> <td>VIBRATION PUMP</td> <td>1</td> <td>PZ</td> </tr> <tr> <td>VL1065A1</td> <td>1/4 MALE N.O. PRESSURE SWITCH</td> <td>1</td> <td>PZ</td> </tr> <tr> <td>VL1067A0</td> <td>WASHING SYSTEM INLETS DISTRIBUTOR</td> <td>1</td> <td>PZ</td> </tr> <tr> <td>VL1080A0</td> <td>DETERGENT FILTER</td> <td>1</td> <td>PZ</td> </tr> <tr> <td>VL1081A0</td> <td>D6 BARBED NO RETURN VALVE</td> <td>2</td> <td>PZ</td> </tr> <tr> <td>VL1083A0</td> <td>D=10 CONNECTION - D=6 PIPE FITTING</td> <td>1</td> <td>PZ</td> </tr> <tr> <td>VL1092A0</td> <td>WASHING SYSTEM OUTLET DOUBLE DISTRIBUTOR</td> <td>1</td> <td>PZ</td> </tr> <tr> <td>VL1102A0</td> <td></td> <td>1</td> <td>PZ</td> </tr> <tr> <td>VL1102A1</td> <td>DETERGENT LINE FILTER + BARBED VNR 6 MM</td> <td>1</td> <td>PZ</td> </tr> <tr> <td>VL1128A0</td> <td>BARBED CHECK VALVE D6</td> <td>1</td> <td>PZ</td> </tr> <tr> <td>VM2172A0</td> <td>PUMP LOCKING CLIP</td> <td>1</td> <td>PZ</td> </tr> </tbody> </table>	Code	Description	Qty	UOM	RC1242A0	D=10 CLOSED CAP	2	PZ	RC1310A0	140X4 CLAMP WITH CLIP	2	PZ	RC1356A0	STRAIGHT THREADED FEMALE END 8X1/4" BSP	1	PZ	RC1408A0	DOUBLE WIRE SPRING CLAMP D10.8 ZN	2	PZ	TB1818A0	JG Ø8 BLUE PE PIPE	0.220	M	TB2820A0	PIPE EPDM FOR WASHING SYSTEM	2.040	M	VI1220A1	4.2X12 TCB SELF-TAPPIN G SCREW	2	PZ	VL1019A0	VIBRATION PUMP	1	PZ	VL1065A1	1/4 MALE N.O. PRESSURE SWITCH	1	PZ	VL1067A0	WASHING SYSTEM INLETS DISTRIBUTOR	1	PZ	VL1080A0	DETERGENT FILTER	1	PZ	VL1081A0	D6 BARBED NO RETURN VALVE	2	PZ	VL1083A0	D=10 CONNECTION - D=6 PIPE FITTING	1	PZ	VL1092A0	WASHING SYSTEM OUTLET DOUBLE DISTRIBUTOR	1	PZ	VL1102A0		1	PZ	VL1102A1	DETERGENT LINE FILTER + BARBED VNR 6 MM	1	PZ	VL1128A0	BARBED CHECK VALVE D6	1	PZ	VM2172A0	PUMP LOCKING CLIP	1	PZ
					Code	Description	Qty	UOM																																																																									
					RC1242A0	D=10 CLOSED CAP	2	PZ																																																																									
					RC1310A0	140X4 CLAMP WITH CLIP	2	PZ																																																																									
					RC1356A0	STRAIGHT THREADED FEMALE END 8X1/4" BSP	1	PZ																																																																									
					RC1408A0	DOUBLE WIRE SPRING CLAMP D10.8 ZN	2	PZ																																																																									
					TB1818A0	JG Ø8 BLUE PE PIPE	0.220	M																																																																									
					TB2820A0	PIPE EPDM FOR WASHING SYSTEM	2.040	M																																																																									
					VI1220A1	4.2X12 TCB SELF-TAPPIN G SCREW	2	PZ																																																																									
					VL1019A0	VIBRATION PUMP	1	PZ																																																																									
					VL1065A1	1/4 MALE N.O. PRESSURE SWITCH	1	PZ																																																																									
					VL1067A0	WASHING SYSTEM INLETS DISTRIBUTOR	1	PZ																																																																									
					VL1080A0	DETERGENT FILTER	1	PZ																																																																									
					VL1081A0	D6 BARBED NO RETURN VALVE	2	PZ																																																																									
					VL1083A0	D=10 CONNECTION - D=6 PIPE FITTING	1	PZ																																																																									
					VL1092A0	WASHING SYSTEM OUTLET DOUBLE DISTRIBUTOR	1	PZ																																																																									
					VL1102A0		1	PZ																																																																									
					VL1102A1	DETERGENT LINE FILTER + BARBED VNR 6 MM	1	PZ																																																																									
					VL1128A0	BARBED CHECK VALVE D6	1	PZ																																																																									
					VM2172A0	PUMP LOCKING CLIP	1	PZ																																																																									

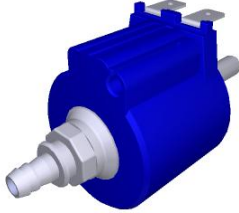
COMPONENT			SPARE PART																																																																														
Code	Description	Image	Code	Description	Components list																																																																												
VL1019A	VIBRATION PUMP		KVL1101A	EUR 1 ROTOR ARM PLUS CLEANING SYSTEM KIT	<table border="1"> <thead> <tr> <th>Code</th> <th>Description</th> <th>Qty</th> <th>UOM</th> </tr> </thead> <tbody> <tr> <td>0H7323A0</td> <td>WASHING SYSTEM HOLDING PLATE</td> <td>1</td> <td>PZ</td> </tr> <tr> <td>0H7820A0</td> <td>PLUS WASHING SY SUPPORT WITH STEAM VALVE</td> <td>1</td> <td>PZ</td> </tr> <tr> <td>EL1252A1</td> <td>1 WAY WATER VALVE + J.G. CONNECTION</td> <td>1</td> <td>PZ</td> </tr> <tr> <td>EL1424A0</td> <td>D8 CONNECTION WATER SOLENOID VALVE</td> <td>1</td> <td>PZ</td> </tr> <tr> <td>EL1436A0</td> <td>H2O SOLENOID JG D8 CHECK VALVE</td> <td>1</td> <td>PZ</td> </tr> <tr> <td>GN1526A0</td> <td>INT. D.=6.9 TH=1.8 O-RIN</td> <td>1</td> <td>PZ</td> </tr> <tr> <td>RC1019A0</td> <td>D=10 ELASTIC CLAMP</td> <td>11</td> <td>PZ</td> </tr> <tr> <td>RC1130A0</td> <td>130X2,6 CLAM</td> <td>1</td> <td>PZ</td> </tr> <tr> <td>RC1242A0</td> <td>D=10 CLOSED CAP</td> <td>2</td> <td>PZ</td> </tr> <tr> <td>RC1310A0</td> <td>140X4 CLAMP WITH CLIP</td> <td>2</td> <td>PZ</td> </tr> <tr> <td>RC1356A0</td> <td>STRAIGHT THREADED FEMALE END 8X1/4" BSP</td> <td>1</td> <td>PZ</td> </tr> <tr> <td>RC1408A0</td> <td>DOUBLE WIRE SPRING CLAMP D10.8 ZN</td> <td>6</td> <td>PZ</td> </tr> <tr> <td>TB1818A0</td> <td>JG Ø8 BLUE PE PIPE</td> <td>0.220</td> <td>M</td> </tr> <tr> <td>TB2820A0</td> <td>PIPE EPDM FOR WASHING SYSTEM</td> <td>1.240</td> <td>M</td> </tr> <tr> <td>VH1220A1</td> <td>4,2X12 TCB SELF-TAPPIN G SCREW</td> <td>2</td> <td>PZ</td> </tr> <tr> <td>VL1019A0</td> <td>VIBRATION PUMP</td> <td>1</td> <td>PZ</td> </tr> <tr> <td>VL1064A0</td> <td>WASHING SYSTEM OUTLETS DISTRIBUTOR</td> <td>1</td> <td>PZ</td> </tr> <tr> <td>VL1065A1</td> <td>1/4 MALE N.O. PRESSURE SWITCH</td> <td>1</td> <td>PZ</td> </tr> </tbody> </table>	Code	Description	Qty	UOM	0H7323A0	WASHING SYSTEM HOLDING PLATE	1	PZ	0H7820A0	PLUS WASHING SY SUPPORT WITH STEAM VALVE	1	PZ	EL1252A1	1 WAY WATER VALVE + J.G. CONNECTION	1	PZ	EL1424A0	D8 CONNECTION WATER SOLENOID VALVE	1	PZ	EL1436A0	H2O SOLENOID JG D8 CHECK VALVE	1	PZ	GN1526A0	INT. D.=6.9 TH=1.8 O-RIN	1	PZ	RC1019A0	D=10 ELASTIC CLAMP	11	PZ	RC1130A0	130X2,6 CLAM	1	PZ	RC1242A0	D=10 CLOSED CAP	2	PZ	RC1310A0	140X4 CLAMP WITH CLIP	2	PZ	RC1356A0	STRAIGHT THREADED FEMALE END 8X1/4" BSP	1	PZ	RC1408A0	DOUBLE WIRE SPRING CLAMP D10.8 ZN	6	PZ	TB1818A0	JG Ø8 BLUE PE PIPE	0.220	M	TB2820A0	PIPE EPDM FOR WASHING SYSTEM	1.240	M	VH1220A1	4,2X12 TCB SELF-TAPPIN G SCREW	2	PZ	VL1019A0	VIBRATION PUMP	1	PZ	VL1064A0	WASHING SYSTEM OUTLETS DISTRIBUTOR	1	PZ	VL1065A1	1/4 MALE N.O. PRESSURE SWITCH	1	PZ
Code	Description	Qty	UOM																																																																														
0H7323A0	WASHING SYSTEM HOLDING PLATE	1	PZ																																																																														
0H7820A0	PLUS WASHING SY SUPPORT WITH STEAM VALVE	1	PZ																																																																														
EL1252A1	1 WAY WATER VALVE + J.G. CONNECTION	1	PZ																																																																														
EL1424A0	D8 CONNECTION WATER SOLENOID VALVE	1	PZ																																																																														
EL1436A0	H2O SOLENOID JG D8 CHECK VALVE	1	PZ																																																																														
GN1526A0	INT. D.=6.9 TH=1.8 O-RIN	1	PZ																																																																														
RC1019A0	D=10 ELASTIC CLAMP	11	PZ																																																																														
RC1130A0	130X2,6 CLAM	1	PZ																																																																														
RC1242A0	D=10 CLOSED CAP	2	PZ																																																																														
RC1310A0	140X4 CLAMP WITH CLIP	2	PZ																																																																														
RC1356A0	STRAIGHT THREADED FEMALE END 8X1/4" BSP	1	PZ																																																																														
RC1408A0	DOUBLE WIRE SPRING CLAMP D10.8 ZN	6	PZ																																																																														
TB1818A0	JG Ø8 BLUE PE PIPE	0.220	M																																																																														
TB2820A0	PIPE EPDM FOR WASHING SYSTEM	1.240	M																																																																														
VH1220A1	4,2X12 TCB SELF-TAPPIN G SCREW	2	PZ																																																																														
VL1019A0	VIBRATION PUMP	1	PZ																																																																														
VL1064A0	WASHING SYSTEM OUTLETS DISTRIBUTOR	1	PZ																																																																														
VL1065A1	1/4 MALE N.O. PRESSURE SWITCH	1	PZ																																																																														



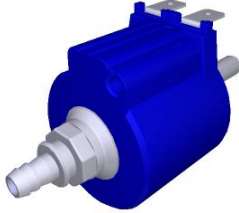

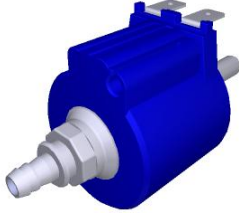

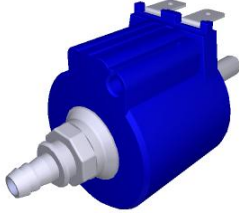
COMPONENT			SPARE PART																																							
Code	Description	Image	Code	Description	Components list																																					
VL1019A	VIBRATION PUMP		KVL1101A	EUR 1 ROTOR ARM PLUS CLEANING SYSTEM KIT	<table border="1"> <thead> <tr> <th>Code</th> <th>Description</th> <th>Qty</th> <th>UOM</th> </tr> </thead> <tbody> <tr> <td>VL1067A0</td> <td>WASHING SYSTEM INLETS DISTRIBUTOR</td> <td>1</td> <td>PZ</td> </tr> <tr> <td>VL1080A0</td> <td>DETERGENT FILTER</td> <td>1</td> <td>PZ</td> </tr> <tr> <td>VL1081A0</td> <td>D6 BARBED NO RETURN VALVE</td> <td>2</td> <td>PZ</td> </tr> <tr> <td>VL1083A0</td> <td>D=10 CONNECTION - D=6 PIPE FITTING</td> <td>1</td> <td>PZ</td> </tr> <tr> <td>VL1102A0</td> <td></td> <td>1</td> <td>PZ</td> </tr> <tr> <td>VL1102A1</td> <td>DETERGENT LINE FILTER + BARBED VNR 6 MM</td> <td>1</td> <td>PZ</td> </tr> <tr> <td>VL1128A0</td> <td>BARBED CHECK VALVE D6</td> <td>1</td> <td>PZ</td> </tr> <tr> <td>VM2172A0</td> <td>PUMP LOCKING CLIP</td> <td>1</td> <td>PZ</td> </tr> </tbody> </table>	Code	Description	Qty	UOM	VL1067A0	WASHING SYSTEM INLETS DISTRIBUTOR	1	PZ	VL1080A0	DETERGENT FILTER	1	PZ	VL1081A0	D6 BARBED NO RETURN VALVE	2	PZ	VL1083A0	D=10 CONNECTION - D=6 PIPE FITTING	1	PZ	VL1102A0		1	PZ	VL1102A1	DETERGENT LINE FILTER + BARBED VNR 6 MM	1	PZ	VL1128A0	BARBED CHECK VALVE D6	1	PZ	VM2172A0	PUMP LOCKING CLIP	1	PZ	
			Code	Description	Qty	UOM																																				
VL1067A0	WASHING SYSTEM INLETS DISTRIBUTOR	1	PZ																																							
VL1080A0	DETERGENT FILTER	1	PZ																																							
VL1081A0	D6 BARBED NO RETURN VALVE	2	PZ																																							
VL1083A0	D=10 CONNECTION - D=6 PIPE FITTING	1	PZ																																							
VL1102A0		1	PZ																																							
VL1102A1	DETERGENT LINE FILTER + BARBED VNR 6 MM	1	PZ																																							
VL1128A0	BARBED CHECK VALVE D6	1	PZ																																							
VM2172A0	PUMP LOCKING CLIP	1	PZ																																							
KVL1094A	0311 EUR CLEANING SYSTEM KIT	<table border="1"> <thead> <tr> <th>Code</th> <th>Description</th> <th>Qty</th> <th>UOM</th> </tr> </thead> <tbody> <tr> <td>0H7494A0</td> <td>ONE-03 WASHING SYST HOLDING PLATE</td> <td>1</td> <td>PZ</td> </tr> <tr> <td>0H7494B0</td> <td>ONE-03 WASHING SYST HOLDING PLATE</td> <td>1</td> <td>PZ</td> </tr> <tr> <td>EL1436A0</td> <td>H2O SOLENOID JG D8 CHECK VALVE</td> <td>1</td> <td>PZ</td> </tr> <tr> <td>GN1526A0</td> <td>INT. D.=6.9 TH=1.8 O-RIN</td> <td>1</td> <td>PZ</td> </tr> <tr> <td>RC1006A0</td> <td>D8 PET PIPE GUIDE BEND</td> <td>2</td> <td>PZ</td> </tr> <tr> <td>RC1019A0</td> <td>D=10 ELASTIC CLAMP</td> <td>15</td> <td>PZ</td> </tr> <tr> <td>RC1242A0</td> <td>D=10 CLOSED CAP</td> <td>2</td> <td>PZ</td> </tr> <tr> <td>RC1408A0</td> <td>DOUBLE WIRE SPRING CLAMP D10.8 ZN</td> <td>4</td> <td>PZ</td> </tr> <tr> <td>TB1818A0</td> <td>JG Ø8 BLUE PE PIPE</td> <td>0.320</td> <td>M</td> </tr> </tbody> </table>	Code	Description	Qty	UOM	0H7494A0	ONE-03 WASHING SYST HOLDING PLATE	1	PZ	0H7494B0	ONE-03 WASHING SYST HOLDING PLATE	1	PZ	EL1436A0	H2O SOLENOID JG D8 CHECK VALVE	1	PZ	GN1526A0	INT. D.=6.9 TH=1.8 O-RIN	1	PZ	RC1006A0	D8 PET PIPE GUIDE BEND	2	PZ	RC1019A0	D=10 ELASTIC CLAMP	15	PZ	RC1242A0	D=10 CLOSED CAP	2	PZ	RC1408A0	DOUBLE WIRE SPRING CLAMP D10.8 ZN	4	PZ	TB1818A0	JG Ø8 BLUE PE PIPE	0.320	M
Code	Description	Qty	UOM																																							
0H7494A0	ONE-03 WASHING SYST HOLDING PLATE	1	PZ																																							
0H7494B0	ONE-03 WASHING SYST HOLDING PLATE	1	PZ																																							
EL1436A0	H2O SOLENOID JG D8 CHECK VALVE	1	PZ																																							
GN1526A0	INT. D.=6.9 TH=1.8 O-RIN	1	PZ																																							
RC1006A0	D8 PET PIPE GUIDE BEND	2	PZ																																							
RC1019A0	D=10 ELASTIC CLAMP	15	PZ																																							
RC1242A0	D=10 CLOSED CAP	2	PZ																																							
RC1408A0	DOUBLE WIRE SPRING CLAMP D10.8 ZN	4	PZ																																							
TB1818A0	JG Ø8 BLUE PE PIPE	0.320	M																																							

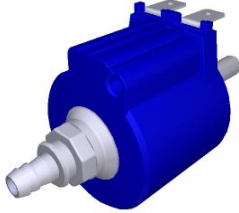
COMPONENT			SPARE PART																																																		
Code	Description	Image	Code	Description	Components list																																																
VL1019A	VIBRATION PUMP		KVL1094A	0311 EUR CLEANING SYSTEM KIT	<table border="1"> <thead> <tr> <th>Code</th> <th>Description</th> <th>Qty</th> <th>UOM</th> </tr> </thead> <tbody> <tr> <td>TB2820A0</td> <td>PIPE EPDM FOR WASHING SYSTEM</td> <td>1.030</td> <td>M</td> </tr> <tr> <td>VI1220A1</td> <td>4,2X12 TCB SELF-TAPPIN G SCREW</td> <td>1</td> <td>PZ</td> </tr> <tr> <td>VL1019A0</td> <td>VIBRATION PUMP</td> <td>1</td> <td>PZ</td> </tr> <tr> <td>VL1053B0</td> <td>ONE WASHING SYS EXT DISTRIBUTOR</td> <td>1</td> <td>PZ</td> </tr> <tr> <td>VL1054B0</td> <td>ONE WASHING SYS INLET DISTRIBUTOR</td> <td>1</td> <td>PZ</td> </tr> <tr> <td>VL1080A0</td> <td>DETERGENT FILTER</td> <td>1</td> <td>PZ</td> </tr> <tr> <td>VL1081A0</td> <td>D6 BARBED NO RETURN VALVE</td> <td>1</td> <td>PZ</td> </tr> <tr> <td>VL1102A0</td> <td></td> <td>1</td> <td>PZ</td> </tr> <tr> <td>VL1102A1</td> <td>DETERGENT LINE FILTER + BARBED VNR 6 MM</td> <td>1</td> <td>PZ</td> </tr> <tr> <td>VL1128A0</td> <td>BARBED CHECK VALVE D6</td> <td>1</td> <td>PZ</td> </tr> <tr> <td>VM2172A0</td> <td>PUMP LOCKING CLIP</td> <td>1</td> <td>PZ</td> </tr> </tbody> </table>	Code	Description	Qty	UOM	TB2820A0	PIPE EPDM FOR WASHING SYSTEM	1.030	M	VI1220A1	4,2X12 TCB SELF-TAPPIN G SCREW	1	PZ	VL1019A0	VIBRATION PUMP	1	PZ	VL1053B0	ONE WASHING SYS EXT DISTRIBUTOR	1	PZ	VL1054B0	ONE WASHING SYS INLET DISTRIBUTOR	1	PZ	VL1080A0	DETERGENT FILTER	1	PZ	VL1081A0	D6 BARBED NO RETURN VALVE	1	PZ	VL1102A0		1	PZ	VL1102A1	DETERGENT LINE FILTER + BARBED VNR 6 MM	1	PZ	VL1128A0	BARBED CHECK VALVE D6	1	PZ	VM2172A0	PUMP LOCKING CLIP	1	PZ
			Code	Description	Qty	UOM																																															
TB2820A0	PIPE EPDM FOR WASHING SYSTEM	1.030	M																																																		
VI1220A1	4,2X12 TCB SELF-TAPPIN G SCREW	1	PZ																																																		
VL1019A0	VIBRATION PUMP	1	PZ																																																		
VL1053B0	ONE WASHING SYS EXT DISTRIBUTOR	1	PZ																																																		
VL1054B0	ONE WASHING SYS INLET DISTRIBUTOR	1	PZ																																																		
VL1080A0	DETERGENT FILTER	1	PZ																																																		
VL1081A0	D6 BARBED NO RETURN VALVE	1	PZ																																																		
VL1102A0		1	PZ																																																		
VL1102A1	DETERGENT LINE FILTER + BARBED VNR 6 MM	1	PZ																																																		
VL1128A0	BARBED CHECK VALVE D6	1	PZ																																																		
VM2172A0	PUMP LOCKING CLIP	1	PZ																																																		
KVL1092A	EUR 2 ROTOR ARMS PLUS CHEMICAL PUMP KIT	<table border="1"> <thead> <tr> <th>Code</th> <th>Description</th> <th>Qty</th> <th>UOM</th> </tr> </thead> <tbody> <tr> <td>GN1526A0</td> <td>INT. D.=6.9 TH=1.8 O-RIN</td> <td>1</td> <td>PZ</td> </tr> <tr> <td>RC1019A0</td> <td>D=10 ELASTIC CLAMP</td> <td>4</td> <td>PZ</td> </tr> <tr> <td>RC1130A0</td> <td>130X2,6 CLAM</td> <td>1</td> <td>PZ</td> </tr> <tr> <td>RC1242A0</td> <td>D=10 CLOSED CAP</td> <td>2</td> <td>PZ</td> </tr> <tr> <td>RC1408A0</td> <td>DOUBLE WIRE SPRING CLAMP D10.8 ZN</td> <td>4</td> <td>PZ</td> </tr> <tr> <td>TB2820A0</td> <td>PIPE EPDM FOR WASHING SYSTEM</td> <td>0.120</td> <td>M</td> </tr> <tr> <td>VI1220A1</td> <td>4,2X12 TCB SELF-TAPPIN G SCREW</td> <td>2</td> <td>PZ</td> </tr> <tr> <td>VL1019A0</td> <td>VIBRATION PUMP</td> <td>1</td> <td>PZ</td> </tr> </tbody> </table>	Code	Description	Qty	UOM	GN1526A0	INT. D.=6.9 TH=1.8 O-RIN	1	PZ	RC1019A0	D=10 ELASTIC CLAMP	4	PZ	RC1130A0	130X2,6 CLAM	1	PZ	RC1242A0	D=10 CLOSED CAP	2	PZ	RC1408A0	DOUBLE WIRE SPRING CLAMP D10.8 ZN	4	PZ	TB2820A0	PIPE EPDM FOR WASHING SYSTEM	0.120	M	VI1220A1	4,2X12 TCB SELF-TAPPIN G SCREW	2	PZ	VL1019A0	VIBRATION PUMP	1	PZ															
Code	Description	Qty	UOM																																																		
GN1526A0	INT. D.=6.9 TH=1.8 O-RIN	1	PZ																																																		
RC1019A0	D=10 ELASTIC CLAMP	4	PZ																																																		
RC1130A0	130X2,6 CLAM	1	PZ																																																		
RC1242A0	D=10 CLOSED CAP	2	PZ																																																		
RC1408A0	DOUBLE WIRE SPRING CLAMP D10.8 ZN	4	PZ																																																		
TB2820A0	PIPE EPDM FOR WASHING SYSTEM	0.120	M																																																		
VI1220A1	4,2X12 TCB SELF-TAPPIN G SCREW	2	PZ																																																		
VL1019A0	VIBRATION PUMP	1	PZ																																																		

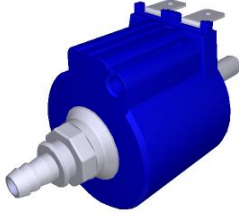
COMPONENT			SPARE PART																																																			
Code	Description	Image	Code	Description	Components list																																																	
VL1019A	VIBRATION PUMP		KVL1092A	EUR 2 ROTOR ARMS PLUS CHEMICAL PUMP KIT	<table border="1"> <thead> <tr> <th>Code</th> <th>Description</th> <th>Qty</th> <th>UOM</th> </tr> </thead> <tbody> <tr> <td>VL1067A0</td> <td>WASHING SYSTEM INLETS DISTRIBUTOR</td> <td>1</td> <td>PZ</td> </tr> <tr> <td>VL1081A0</td> <td>D6 BARBED NO RETURN VALVE</td> <td>1</td> <td>PZ</td> </tr> <tr> <td>VL1092A0</td> <td>WASHING SYSTEM OUTLET DOUBLE DISTRIBUTOR</td> <td>1</td> <td>PZ</td> </tr> <tr> <td>VL1128A0</td> <td>BARBED CHECK VALVE D6</td> <td>1</td> <td>PZ</td> </tr> <tr> <td>VM2172A0</td> <td>PUMP LOCKING CLIP</td> <td>1</td> <td>PZ</td> </tr> </tbody> </table>	Code	Description	Qty	UOM	VL1067A0	WASHING SYSTEM INLETS DISTRIBUTOR	1	PZ	VL1081A0	D6 BARBED NO RETURN VALVE	1	PZ	VL1092A0	WASHING SYSTEM OUTLET DOUBLE DISTRIBUTOR	1	PZ	VL1128A0	BARBED CHECK VALVE D6	1	PZ	VM2172A0	PUMP LOCKING CLIP	1	PZ																									
			Code	Description	Qty	UOM																																																
			VL1067A0	WASHING SYSTEM INLETS DISTRIBUTOR	1	PZ																																																
VL1081A0	D6 BARBED NO RETURN VALVE	1	PZ																																																			
VL1092A0	WASHING SYSTEM OUTLET DOUBLE DISTRIBUTOR	1	PZ																																																			
VL1128A0	BARBED CHECK VALVE D6	1	PZ																																																			
VM2172A0	PUMP LOCKING CLIP	1	PZ																																																			
KVL1073A	EUR 1 ROTOR ARM PLUS CHEMICAL PUMP KIT	<table border="1"> <thead> <tr> <th>Code</th> <th>Description</th> <th>Qty</th> <th>UOM</th> </tr> </thead> <tbody> <tr> <td>GN1526A0</td> <td>INT. D.=6.9 TH=1.8 O-RIN</td> <td>1</td> <td>PZ</td> </tr> <tr> <td>RC1019A0</td> <td>D=10 ELASTIC CLAMP</td> <td>4</td> <td>PZ</td> </tr> <tr> <td>RC1130A0</td> <td>130X2,6 CLAM</td> <td>1</td> <td>PZ</td> </tr> <tr> <td>RC1242A0</td> <td>D=10 CLOSED CAP</td> <td>2</td> <td>PZ</td> </tr> <tr> <td>RC1408A0</td> <td>DOUBLE WIRE SPRING CLAMP D10.8 ZN</td> <td>2</td> <td>PZ</td> </tr> <tr> <td>TB2820A0</td> <td>PIPE EPDM FOR WASHING SYSTEM</td> <td>0.120</td> <td>M</td> </tr> <tr> <td>VL1019A0</td> <td>VIBRATION PUMP</td> <td>1</td> <td>PZ</td> </tr> <tr> <td>VL1064A0</td> <td>WASHING SYSTEM OUTLETS DISTRIBUTOR</td> <td>1</td> <td>PZ</td> </tr> <tr> <td>VL1067A0</td> <td>WASHING SYSTEM INLETS DISTRIBUTOR</td> <td>1</td> <td>PZ</td> </tr> <tr> <td>VL1081A0</td> <td>D6 BARBED NO RETURN VALVE</td> <td>1</td> <td>PZ</td> </tr> <tr> <td>VL1128A0</td> <td>BARBED CHECK VALVE D6</td> <td>1</td> <td>PZ</td> </tr> <tr> <td>VM2172A0</td> <td>PUMP LOCKING CLIP</td> <td>1</td> <td>PZ</td> </tr> </tbody> </table>	Code	Description	Qty	UOM	GN1526A0	INT. D.=6.9 TH=1.8 O-RIN	1	PZ	RC1019A0	D=10 ELASTIC CLAMP	4	PZ	RC1130A0	130X2,6 CLAM	1	PZ	RC1242A0	D=10 CLOSED CAP	2	PZ	RC1408A0	DOUBLE WIRE SPRING CLAMP D10.8 ZN	2	PZ	TB2820A0	PIPE EPDM FOR WASHING SYSTEM	0.120	M	VL1019A0	VIBRATION PUMP	1	PZ	VL1064A0	WASHING SYSTEM OUTLETS DISTRIBUTOR	1	PZ	VL1067A0	WASHING SYSTEM INLETS DISTRIBUTOR	1	PZ	VL1081A0	D6 BARBED NO RETURN VALVE	1	PZ	VL1128A0	BARBED CHECK VALVE D6	1	PZ	VM2172A0	PUMP LOCKING CLIP	1	PZ
Code	Description	Qty	UOM																																																			
GN1526A0	INT. D.=6.9 TH=1.8 O-RIN	1	PZ																																																			
RC1019A0	D=10 ELASTIC CLAMP	4	PZ																																																			
RC1130A0	130X2,6 CLAM	1	PZ																																																			
RC1242A0	D=10 CLOSED CAP	2	PZ																																																			
RC1408A0	DOUBLE WIRE SPRING CLAMP D10.8 ZN	2	PZ																																																			
TB2820A0	PIPE EPDM FOR WASHING SYSTEM	0.120	M																																																			
VL1019A0	VIBRATION PUMP	1	PZ																																																			
VL1064A0	WASHING SYSTEM OUTLETS DISTRIBUTOR	1	PZ																																																			
VL1067A0	WASHING SYSTEM INLETS DISTRIBUTOR	1	PZ																																																			
VL1081A0	D6 BARBED NO RETURN VALVE	1	PZ																																																			
VL1128A0	BARBED CHECK VALVE D6	1	PZ																																																			
VM2172A0	PUMP LOCKING CLIP	1	PZ																																																			
KVL1072A	ONE SERIES CHEMICAL PUMP KI	<table border="1"> <thead> <tr> <th>Code</th> <th>Description</th> <th>Qty</th> <th>UOM</th> </tr> </thead> <tbody> <tr> <td>GN1526A0</td> <td>INT. D.=6.9 TH=1.8 O-RIN</td> <td>1</td> <td>PZ</td> </tr> </tbody> </table>	Code	Description	Qty	UOM	GN1526A0	INT. D.=6.9 TH=1.8 O-RIN	1	PZ																																												
Code	Description	Qty	UOM																																																			
GN1526A0	INT. D.=6.9 TH=1.8 O-RIN	1	PZ																																																			

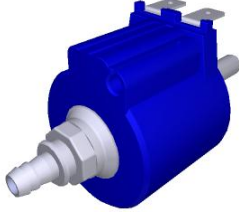
COMPONENT			SPARE PART																																																		
Code	Description	Image	Code	Description	Components list																																																
VL1019A	VIBRATION PUMP		KVL1072A	ONE SERIES CHEMICAL PUMP KI	<table border="1"> <thead> <tr> <th>Code</th> <th>Description</th> <th>Qty</th> <th>UOM</th> </tr> </thead> <tbody> <tr> <td>RC1019A0</td> <td>D=10 ELASTIC CLAMP</td> <td>3</td> <td>PZ</td> </tr> <tr> <td>RC1242A0</td> <td>D=10 CLOSED CAP</td> <td>2</td> <td>PZ</td> </tr> <tr> <td>RC1408A0</td> <td>DOUBLE WIRE SPRING CLAMP D10.8 ZN</td> <td>2</td> <td>PZ</td> </tr> <tr> <td>TB2820A0</td> <td>PIPE EPDM FOR WASHING SYSTEM</td> <td>0.120</td> <td>M</td> </tr> <tr> <td>VI1220A1</td> <td>4,2X12 TCB SELF-TAPPIN G SCREW</td> <td>1</td> <td>PZ</td> </tr> <tr> <td>VL1019A0</td> <td>VIBRATION PUMP</td> <td>1</td> <td>PZ</td> </tr> <tr> <td>VL1053B0</td> <td>ONE WASHING SYS EXT DISTRIBUTOR</td> <td>1</td> <td>PZ</td> </tr> <tr> <td>VL1054B0</td> <td>ONE WASHING SYS INLET DISTRIBUTOR</td> <td>1</td> <td>PZ</td> </tr> <tr> <td>VL1081A0</td> <td>D6 BARBED NO RETURN VALVE</td> <td>2</td> <td>PZ</td> </tr> <tr> <td>VL1128A0</td> <td>BARBED CHECK VALVE D6</td> <td>1</td> <td>PZ</td> </tr> <tr> <td>VM2172A0</td> <td>PUMP LOCKING CLIP</td> <td>1</td> <td>PZ</td> </tr> </tbody> </table>	Code	Description	Qty	UOM	RC1019A0	D=10 ELASTIC CLAMP	3	PZ	RC1242A0	D=10 CLOSED CAP	2	PZ	RC1408A0	DOUBLE WIRE SPRING CLAMP D10.8 ZN	2	PZ	TB2820A0	PIPE EPDM FOR WASHING SYSTEM	0.120	M	VI1220A1	4,2X12 TCB SELF-TAPPIN G SCREW	1	PZ	VL1019A0	VIBRATION PUMP	1	PZ	VL1053B0	ONE WASHING SYS EXT DISTRIBUTOR	1	PZ	VL1054B0	ONE WASHING SYS INLET DISTRIBUTOR	1	PZ	VL1081A0	D6 BARBED NO RETURN VALVE	2	PZ	VL1128A0	BARBED CHECK VALVE D6	1	PZ	VM2172A0	PUMP LOCKING CLIP	1	PZ
					Code	Description	Qty	UOM																																													
RC1019A0	D=10 ELASTIC CLAMP	3	PZ																																																		
RC1242A0	D=10 CLOSED CAP	2	PZ																																																		
RC1408A0	DOUBLE WIRE SPRING CLAMP D10.8 ZN	2	PZ																																																		
TB2820A0	PIPE EPDM FOR WASHING SYSTEM	0.120	M																																																		
VI1220A1	4,2X12 TCB SELF-TAPPIN G SCREW	1	PZ																																																		
VL1019A0	VIBRATION PUMP	1	PZ																																																		
VL1053B0	ONE WASHING SYS EXT DISTRIBUTOR	1	PZ																																																		
VL1054B0	ONE WASHING SYS INLET DISTRIBUTOR	1	PZ																																																		
VL1081A0	D6 BARBED NO RETURN VALVE	2	PZ																																																		
VL1128A0	BARBED CHECK VALVE D6	1	PZ																																																		
VM2172A0	PUMP LOCKING CLIP	1	PZ																																																		
KVL0001A	LM TOP CLEANING SYSTEM KIT	<table border="1"> <thead> <tr> <th>Code</th> <th>Description</th> <th>Qty</th> <th>UOM</th> </tr> </thead> <tbody> <tr> <td>0H1226A0</td> <td>LINEMISSTOP WASHING SYTEM CIRCUIT COVE</td> <td>1</td> <td>PZ</td> </tr> <tr> <td>0H1226B0</td> <td>LINEMISSTOP WASHING SYTEM CIRCUIT COVE</td> <td>1</td> <td>PZ</td> </tr> <tr> <td>EL1180A0</td> <td>Ø8-Ø8 FEMALE NON-RETURN CONNECTION</td> <td>1</td> <td>PZ</td> </tr> <tr> <td>GN1312A0</td> <td>RUBBER CABLE-PASSI NG DE=26 DI=15 SP=10</td> <td>1</td> <td>PZ</td> </tr> <tr> <td>GN1526A0</td> <td>INT. D.=6.9 TH=1.8 O-RIN</td> <td>1</td> <td>PZ</td> </tr> <tr> <td>RC1008A0</td> <td>D9 ELASTIC CLIP</td> <td>3</td> <td>PZ</td> </tr> </tbody> </table>	Code	Description	Qty	UOM	0H1226A0	LINEMISSTOP WASHING SYTEM CIRCUIT COVE	1	PZ	0H1226B0	LINEMISSTOP WASHING SYTEM CIRCUIT COVE	1	PZ	EL1180A0	Ø8-Ø8 FEMALE NON-RETURN CONNECTION	1	PZ	GN1312A0	RUBBER CABLE-PASSI NG DE=26 DI=15 SP=10	1	PZ	GN1526A0	INT. D.=6.9 TH=1.8 O-RIN	1	PZ	RC1008A0	D9 ELASTIC CLIP	3	PZ																							
Code	Description	Qty	UOM																																																		
0H1226A0	LINEMISSTOP WASHING SYTEM CIRCUIT COVE	1	PZ																																																		
0H1226B0	LINEMISSTOP WASHING SYTEM CIRCUIT COVE	1	PZ																																																		
EL1180A0	Ø8-Ø8 FEMALE NON-RETURN CONNECTION	1	PZ																																																		
GN1312A0	RUBBER CABLE-PASSI NG DE=26 DI=15 SP=10	1	PZ																																																		
GN1526A0	INT. D.=6.9 TH=1.8 O-RIN	1	PZ																																																		
RC1008A0	D9 ELASTIC CLIP	3	PZ																																																		

COMPONENT			SPARE PART																																																																																		
Code	Description	Image	Code	Description	Components list																																																																																
VL1019A	VIBRATION PUMP		KVL0001A	LM TOP CLEANING SYSTEM KIT	<table border="1"> <thead> <tr> <th>Code</th> <th>Description</th> <th>Qty</th> <th>UOM</th> </tr> </thead> <tbody> <tr> <td>RC1019A0</td> <td>D=10 ELASTIC CLAMP</td> <td>3</td> <td>PZ</td> </tr> <tr> <td>RC1242A0</td> <td>D=10 CLOSED CAP</td> <td>2</td> <td>PZ</td> </tr> <tr> <td>RC1381A0</td> <td>BIFILAR PIPE CLIP D10.7</td> <td>3</td> <td>PZ</td> </tr> <tr> <td>RC1408A0</td> <td>DOUBLE WIRE SPRING CLAMP D10.8 ZN</td> <td>2</td> <td>PZ</td> </tr> <tr> <td>TB2343A0</td> <td>9X6 PVC TRANSPAREN T PIPE</td> <td>2.630</td> <td>M</td> </tr> <tr> <td>TB2820A0</td> <td>PIPE EPDM FOR WASHING SYSTEM</td> <td>0.990</td> <td>M</td> </tr> <tr> <td>V11220A1</td> <td>4,2X12 TCB SELF-TAPPIN G SCREW</td> <td>1</td> <td>PZ</td> </tr> <tr> <td>VL1019A0</td> <td>VIBRATION PUMP</td> <td>1</td> <td>PZ</td> </tr> <tr> <td>VL1041C0</td> <td>DETERGENT CAP WITH Ø12 HOLE</td> <td>1</td> <td>PZ</td> </tr> <tr> <td>VL1047A1</td> <td>D6 PIPE HOLDER - D8 J.G. TERMINAL</td> <td>1</td> <td>PZ</td> </tr> <tr> <td>VL1053A1</td> <td>ONE</td> <td>1</td> <td>PZ</td> </tr> <tr> <td>VL1053B0</td> <td>WASHING SYS EXT DISTRIBUTOR</td> <td>1</td> <td>PZ</td> </tr> <tr> <td>VL1054A1</td> <td>ONE</td> <td>1</td> <td>PZ</td> </tr> <tr> <td>VL1054B0</td> <td>WASHING SYS INLET DISTRIBUTOR</td> <td>1</td> <td>PZ</td> </tr> <tr> <td>VL1061A0</td> <td>HOLD DOWN WEIGHT+NET FILTER+NON-RET. V.</td> <td>1</td> <td>PZ</td> </tr> <tr> <td>VL1081A0</td> <td>D6 BARBED NO RETURN VALVE</td> <td>1</td> <td>PZ</td> </tr> <tr> <td>VL1128A0</td> <td>BARBED CHECK VALVE D6</td> <td>2</td> <td>PZ</td> </tr> <tr> <td>VM1066A0</td> <td>SADDLE CLIP FOR CABLES PASSING</td> <td>3</td> <td>PZ</td> </tr> <tr> <td>VM1088A0</td> <td>NYLON CLICK CLAMP D7.9-D9.2</td> <td>1</td> <td>PZ</td> </tr> </tbody> </table>	Code	Description	Qty	UOM	RC1019A0	D=10 ELASTIC CLAMP	3	PZ	RC1242A0	D=10 CLOSED CAP	2	PZ	RC1381A0	BIFILAR PIPE CLIP D10.7	3	PZ	RC1408A0	DOUBLE WIRE SPRING CLAMP D10.8 ZN	2	PZ	TB2343A0	9X6 PVC TRANSPAREN T PIPE	2.630	M	TB2820A0	PIPE EPDM FOR WASHING SYSTEM	0.990	M	V11220A1	4,2X12 TCB SELF-TAPPIN G SCREW	1	PZ	VL1019A0	VIBRATION PUMP	1	PZ	VL1041C0	DETERGENT CAP WITH Ø12 HOLE	1	PZ	VL1047A1	D6 PIPE HOLDER - D8 J.G. TERMINAL	1	PZ	VL1053A1	ONE	1	PZ	VL1053B0	WASHING SYS EXT DISTRIBUTOR	1	PZ	VL1054A1	ONE	1	PZ	VL1054B0	WASHING SYS INLET DISTRIBUTOR	1	PZ	VL1061A0	HOLD DOWN WEIGHT+NET FILTER+NON-RET. V.	1	PZ	VL1081A0	D6 BARBED NO RETURN VALVE	1	PZ	VL1128A0	BARBED CHECK VALVE D6	2	PZ	VM1066A0	SADDLE CLIP FOR CABLES PASSING	3	PZ	VM1088A0	NYLON CLICK CLAMP D7.9-D9.2	1	PZ
					Code	Description	Qty	UOM																																																																													
RC1019A0	D=10 ELASTIC CLAMP	3	PZ																																																																																		
RC1242A0	D=10 CLOSED CAP	2	PZ																																																																																		
RC1381A0	BIFILAR PIPE CLIP D10.7	3	PZ																																																																																		
RC1408A0	DOUBLE WIRE SPRING CLAMP D10.8 ZN	2	PZ																																																																																		
TB2343A0	9X6 PVC TRANSPAREN T PIPE	2.630	M																																																																																		
TB2820A0	PIPE EPDM FOR WASHING SYSTEM	0.990	M																																																																																		
V11220A1	4,2X12 TCB SELF-TAPPIN G SCREW	1	PZ																																																																																		
VL1019A0	VIBRATION PUMP	1	PZ																																																																																		
VL1041C0	DETERGENT CAP WITH Ø12 HOLE	1	PZ																																																																																		
VL1047A1	D6 PIPE HOLDER - D8 J.G. TERMINAL	1	PZ																																																																																		
VL1053A1	ONE	1	PZ																																																																																		
VL1053B0	WASHING SYS EXT DISTRIBUTOR	1	PZ																																																																																		
VL1054A1	ONE	1	PZ																																																																																		
VL1054B0	WASHING SYS INLET DISTRIBUTOR	1	PZ																																																																																		
VL1061A0	HOLD DOWN WEIGHT+NET FILTER+NON-RET. V.	1	PZ																																																																																		
VL1081A0	D6 BARBED NO RETURN VALVE	1	PZ																																																																																		
VL1128A0	BARBED CHECK VALVE D6	2	PZ																																																																																		
VM1066A0	SADDLE CLIP FOR CABLES PASSING	3	PZ																																																																																		
VM1088A0	NYLON CLICK CLAMP D7.9-D9.2	1	PZ																																																																																		

COMPONENT			SPARE PART																		
Code	Description	Image	Code	Description	Components list																
VL1019A	VIBRATION PUMP		KVL0001A	LM TOP CLEANING SYSTEM KIT	<table border="1"> <thead> <tr> <th>Code</th> <th>Description</th> <th>Qty</th> <th>UOM</th> </tr> </thead> <tbody> <tr> <td>VM1605A0</td> <td>CLIP TWIST LOCK DIAM. 10,2-12,7 MM</td> <td>1</td> <td>PZ</td> </tr> <tr> <td>VM1610A0</td> <td>CLIP TWIST LOCK DIAM. 7,6-10,2 MM</td> <td>1</td> <td>PZ</td> </tr> <tr> <td>VM2172A0</td> <td>PUMP LOCKING CLIP</td> <td>1</td> <td>PZ</td> </tr> </tbody> </table>	Code	Description	Qty	UOM	VM1605A0	CLIP TWIST LOCK DIAM. 10,2-12,7 MM	1	PZ	VM1610A0	CLIP TWIST LOCK DIAM. 7,6-10,2 MM	1	PZ	VM2172A0	PUMP LOCKING CLIP	1	PZ
Code	Description	Qty	UOM																		
VM1605A0	CLIP TWIST LOCK DIAM. 10,2-12,7 MM	1	PZ																		
VM1610A0	CLIP TWIST LOCK DIAM. 7,6-10,2 MM	1	PZ																		
VM2172A0	PUMP LOCKING CLIP	1	PZ																		
VM2172A	PUMP LOCKING CLI		VM2172A0	PUMP LOCKING CLI																	
RC1019A	D=10 ELASTIC CLAM		KRC1019A	Ø10 ZINC PLATED ELASTIC CLAMP 15 PCS KIT	<table border="1"> <thead> <tr> <th>Code</th> <th>Description</th> <th>Qty</th> <th>UOM</th> </tr> </thead> <tbody> <tr> <td>RC1019A0</td> <td>D=10 ELASTIC CLAMP</td> <td>15</td> <td>PZ</td> </tr> </tbody> </table>	Code	Description	Qty	UOM	RC1019A0	D=10 ELASTIC CLAMP	15	PZ								
Code	Description	Qty	UOM																		
RC1019A0	D=10 ELASTIC CLAMP	15	PZ																		
VL1081A	D6 BARBED NO RETURN VALVE		KVL1128A	D6 VNR BARBED VALVE KIT	<table border="1"> <thead> <tr> <th>Code</th> <th>Description</th> <th>Qty</th> <th>UOM</th> </tr> </thead> <tbody> <tr> <td>RC1019A0</td> <td>D=10 ELASTIC CLAMP</td> <td>2</td> <td>PZ</td> </tr> <tr> <td>TB2820A0</td> <td>PIPE EPDM FOR WASHING SYSTEM</td> <td>0.080</td> <td>M</td> </tr> <tr> <td>VL1128A0</td> <td>BARBED CHECK VALVE D6</td> <td>1</td> <td>PZ</td> </tr> </tbody> </table>	Code	Description	Qty	UOM	RC1019A0	D=10 ELASTIC CLAMP	2	PZ	TB2820A0	PIPE EPDM FOR WASHING SYSTEM	0.080	M	VL1128A0	BARBED CHECK VALVE D6	1	PZ
Code	Description	Qty	UOM																		
RC1019A0	D=10 ELASTIC CLAMP	2	PZ																		
TB2820A0	PIPE EPDM FOR WASHING SYSTEM	0.080	M																		
VL1128A0	BARBED CHECK VALVE D6	1	PZ																		
RC1242A	D=10 CLOSED CAP		KRC1242A	Ø10 CLOSED CONNECTION 20PCS KIT	<table border="1"> <thead> <tr> <th>Code</th> <th>Description</th> <th>Qty</th> <th>UOM</th> </tr> </thead> <tbody> <tr> <td>RC1242A0</td> <td>D=10 CLOSED CAP</td> <td>20</td> <td>PZ</td> </tr> </tbody> </table>	Code	Description	Qty	UOM	RC1242A0	D=10 CLOSED CAP	20	PZ								
Code	Description	Qty	UOM																		
RC1242A0	D=10 CLOSED CAP	20	PZ																		



COMPONENT			SPARE PART																																																						
Code	Description	Image	Code	Description	Components list																																																				
VL1054B	ONE WASHING SYS INLET DISTRIBUTOR		KVL1054B	ONE WASHING SYST INLETS DISTRIBUTOR KIT	<table border="1"> <thead> <tr> <th>Code</th> <th>Description</th> <th>Qty</th> <th>UOM</th> </tr> </thead> <tbody> <tr> <td>VL1054B0</td> <td>ONE WASHING SYS INLET DISTRIBUTOR</td> <td>1</td> <td>PZ</td> </tr> </tbody> </table>	Code	Description	Qty	UOM	VL1054B0	ONE WASHING SYS INLET DISTRIBUTOR	1	PZ																																												
Code	Description	Qty	UOM																																																						
VL1054B0	ONE WASHING SYS INLET DISTRIBUTOR	1	PZ																																																						
VL1053B	ONE WASHING SYS EXT DISTRIBUTOR		KVL1072A	ONE SERIES CHEMICAL PUMP KI	<table border="1"> <thead> <tr> <th>Code</th> <th>Description</th> <th>Qty</th> <th>UOM</th> </tr> </thead> <tbody> <tr> <td>GN1526A0</td> <td>INT. D.=6.9 TH=1.8 O-RIN</td> <td>1</td> <td>PZ</td> </tr> <tr> <td>RC1019A0</td> <td>D=10 ELASTIC CLAMP</td> <td>3</td> <td>PZ</td> </tr> <tr> <td>RC1242A0</td> <td>D=10 CLOSED CAP</td> <td>2</td> <td>PZ</td> </tr> <tr> <td>RC1408A0</td> <td>DOUBLE WIRE SPRING CLAMP D10.8 ZN</td> <td>2</td> <td>PZ</td> </tr> <tr> <td>TB2820A0</td> <td>PIPE EPDM FOR WASHING SYSTEM</td> <td>0.120</td> <td>M</td> </tr> <tr> <td>VH1220A1</td> <td>4,2X12 TCB SELF-TAPPIN G SCREW</td> <td>1</td> <td>PZ</td> </tr> <tr> <td>VL1019A0</td> <td>VIBRATION PUMP</td> <td>1</td> <td>PZ</td> </tr> <tr> <td>VL1053B0</td> <td>ONE WASHING SYS EXT DISTRIBUTOR</td> <td>1</td> <td>PZ</td> </tr> <tr> <td>VL1054B0</td> <td>ONE WASHING SYS INLET DISTRIBUTOR</td> <td>1</td> <td>PZ</td> </tr> <tr> <td>VL1081A0</td> <td>D6 BARBED NO RETURN VALVE</td> <td>2</td> <td>PZ</td> </tr> <tr> <td>VL1128A0</td> <td>BARBED CHECK VALVE D6</td> <td>1</td> <td>PZ</td> </tr> <tr> <td>VM2172A0</td> <td>PUMP LOCKING CLIP</td> <td>1</td> <td>PZ</td> </tr> </tbody> </table>	Code	Description	Qty	UOM	GN1526A0	INT. D.=6.9 TH=1.8 O-RIN	1	PZ	RC1019A0	D=10 ELASTIC CLAMP	3	PZ	RC1242A0	D=10 CLOSED CAP	2	PZ	RC1408A0	DOUBLE WIRE SPRING CLAMP D10.8 ZN	2	PZ	TB2820A0	PIPE EPDM FOR WASHING SYSTEM	0.120	M	VH1220A1	4,2X12 TCB SELF-TAPPIN G SCREW	1	PZ	VL1019A0	VIBRATION PUMP	1	PZ	VL1053B0	ONE WASHING SYS EXT DISTRIBUTOR	1	PZ	VL1054B0	ONE WASHING SYS INLET DISTRIBUTOR	1	PZ	VL1081A0	D6 BARBED NO RETURN VALVE	2	PZ	VL1128A0	BARBED CHECK VALVE D6	1	PZ	VM2172A0	PUMP LOCKING CLIP	1	PZ
Code	Description	Qty	UOM																																																						
GN1526A0	INT. D.=6.9 TH=1.8 O-RIN	1	PZ																																																						
RC1019A0	D=10 ELASTIC CLAMP	3	PZ																																																						
RC1242A0	D=10 CLOSED CAP	2	PZ																																																						
RC1408A0	DOUBLE WIRE SPRING CLAMP D10.8 ZN	2	PZ																																																						
TB2820A0	PIPE EPDM FOR WASHING SYSTEM	0.120	M																																																						
VH1220A1	4,2X12 TCB SELF-TAPPIN G SCREW	1	PZ																																																						
VL1019A0	VIBRATION PUMP	1	PZ																																																						
VL1053B0	ONE WASHING SYS EXT DISTRIBUTOR	1	PZ																																																						
VL1054B0	ONE WASHING SYS INLET DISTRIBUTOR	1	PZ																																																						
VL1081A0	D6 BARBED NO RETURN VALVE	2	PZ																																																						
VL1128A0	BARBED CHECK VALVE D6	1	PZ																																																						
VM2172A0	PUMP LOCKING CLIP	1	PZ																																																						
RC1408A	DOUBLE WIRE SPRING CLAMP D10.8 ZN		KRC1408A	4 PCS D10.8 DOUBLE WIRE SPRING CLAMP KIT	<table border="1"> <thead> <tr> <th>Code</th> <th>Description</th> <th>Qty</th> <th>UOM</th> </tr> </thead> <tbody> <tr> <td>RC1408A0</td> <td>DOUBLE WIRE SPRING CLAMP D10.8 ZN</td> <td>4</td> <td>PZ</td> </tr> </tbody> </table>	Code	Description	Qty	UOM	RC1408A0	DOUBLE WIRE SPRING CLAMP D10.8 ZN	4	PZ																																												
Code	Description	Qty	UOM																																																						
RC1408A0	DOUBLE WIRE SPRING CLAMP D10.8 ZN	4	PZ																																																						



COMPONENT			SPARE PART										
Code	Description	Image	Code	Description	Components list								
EL1436A	H2O SOLENOID JG D8 CHECK VALVE		KEL1436A	D8 CONNECTION D6 SOLEN.VALVE KIT	<table border="1"> <thead> <tr> <th>Code</th> <th>Description</th> <th>Qty</th> <th>UOM</th> </tr> </thead> <tbody> <tr> <td>EL1436A0</td> <td>H2O SOLENOID JG D8 CHECK VALVE</td> <td>1</td> <td>PZ</td> </tr> </tbody> </table>	Code	Description	Qty	UOM	EL1436A0	H2O SOLENOID JG D8 CHECK VALVE	1	PZ
Code	Description	Qty	UOM										
EL1436A0	H2O SOLENOID JG D8 CHECK VALVE	1	PZ										
TB3009B	TB3132A-ONE OVEN WASHING INLET		KTB1349A	JGØ8 TB1818A WATER INLET PIPE L30M KIT	<table border="1"> <thead> <tr> <th>Code</th> <th>Description</th> <th>Qty</th> <th>UOM</th> </tr> </thead> <tbody> <tr> <td>TB1818A0</td> <td>JG Ø8 BLUE PE PIPE</td> <td>30</td> <td>M</td> </tr> </tbody> </table>	Code	Description	Qty	UOM	TB1818A0	JG Ø8 BLUE PE PIPE	30	M
Code	Description	Qty	UOM										
TB1818A0	JG Ø8 BLUE PE PIPE	30	M										
0H7819A	ONE WASHING SYS SUPPORT WITH STEAM VALVE		0H7819A0	ONE WASHING SYS SUPPORT WITH STEAM VALVE									
TB3207A	CHIMNEY EXTENSION PIPE D5		TB3207A0	CHIMNEY EXTENSION PIPE D5									
VM2450A	THROUGH-WALL CONNECTION 3 PIPES		KVM2450A	3 PIPES THROUGH-WALL CONNECTION KIT	<table border="1"> <thead> <tr> <th>Code</th> <th>Description</th> <th>Qty</th> <th>UOM</th> </tr> </thead> <tbody> <tr> <td>VM2450A0</td> <td>THROUGH-WALL CONNECTION 3 PIPES</td> <td>1</td> <td>PZ</td> </tr> </tbody> </table>	Code	Description	Qty	UOM	VM2450A0	THROUGH-WALL CONNECTION 3 PIPES	1	PZ
Code	Description	Qty	UOM										
VM2450A0	THROUGH-WALL CONNECTION 3 PIPES	1	PZ										